

invenSYS  
Eurotherm

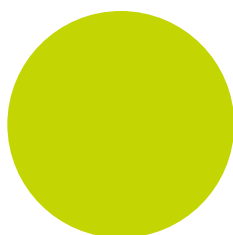

**P304c Melt Pressure  
Controller**

**User  
Manual**

HA031861/3  
Date July 2014

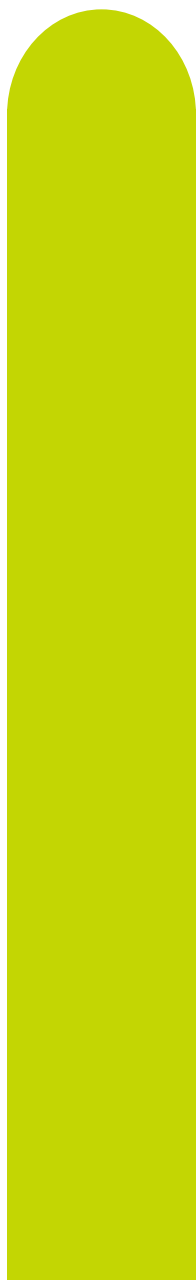



**P304c Melt Pressure Controller**  
**User Manual Part Number HA031861 Issue 3 Date July 2014**

**Contents**

<b>1.</b>	<b>DESCRIPTION.....</b>	<b>3</b>
<b>1.1</b>	<b>Unpacking Your Controller.....</b>	<b>3</b>
<b>1.2</b>	<b>Dimensions.....</b>	<b>3</b>
<b>1.3</b>	<b>Step 1: Installation.....</b>	<b>4</b>
	1.3.1 Panel Mounting the Controller .....	4
	1.3.2 Panel Cut Out Size .....	4
<b>1.4</b>	<b>Order Code .....</b>	<b>5</b>
<b>1.5</b>	<b>Step 2: Wiring .....</b>	<b>6</b>
	1.5.1 Rear Terminal Connections .....	6
	1.5.2 Block Diagram and Isolation Boundaries .....	6
	1.5.3 Wire Sizes .....	6
	1.5.4 Power Supply.....	7
	1.5.5 Sensor Inputs .....	8
	1.5.6 Transmitter Power Supply (TPSU).....	9
	1.5.7 Analogue Outputs.....	10
	1.5.8 Digital Inputs.....	11
	1.5.9 Alarms .....	12
	1.5.10 Modbus Serial Communications.....	13
<b>2.</b>	<b>SAFETY AND EMC INFORMATION .....</b>	<b>14</b>
<b>3.</b>	<b>SWITCH ON .....</b>	<b>15</b>
<b>3.1</b>	<b>Operator Display .....</b>	<b>15</b>
	3.1.1 Status Indication .....	15
	3.1.2 Keyboard.....	15
	3.1.3 Example - To Display Selected Parameters .....	16
<b>3.2</b>	<b>Open Indication .....</b>	<b>16</b>
<b>3.3</b>	<b>Levels of Operation .....</b>	<b>16</b>
<b>3.4</b>	<b>Level 1 Operation .....</b>	<b>17</b>
	3.4.1 Level 1 Parameters.....	17
	3.4.2 Example 1 - To Set Alarm 1 Threshold .....	17
	3.4.3 Example 2 - To Adjust the Output Level in Manual Mode .....	18
<b>3.5</b>	<b>To Select Other Levels of Operation .....</b>	<b>18</b>
<b>3.6</b>	<b>Level 2 Operation .....</b>	<b>19</b>
	3.6.1 Level 2 Parameters.....	19
<b>3.7</b>	<b>To Return to Level 1 .....</b>	<b>21</b>
<b>3.8</b>	<b>Auto / Manual Mode .....</b>	<b>22</b>
<b>3.9</b>	<b>Alarms .....</b>	<b>23</b>
<b>3.10</b>	<b>Definition of Alarm Types .....</b>	<b>23</b>
	3.10.1 Process High.....	23
	3.10.2 Process Low .....	23
	3.10.3 Band High .....	24
	3.10.4 Band Low.....	24
	3.10.5 Deviation High.....	25
	3.10.6 Deviation Low.....	25
	3.10.7 Alarm Mask at Start up .....	26
	3.10.8 Alarm Mask Reset .....	26
	3.10.9 Alarm Reset Mode .....	26
	3.10.10 Alarm Acknowledgement.....	26
	3.10.11 Failsafe mode .....	26
	3.10.12 Threshold .....	26
	3.10.13 Hysteresis .....	26
	3.10.14 Alarm Filter .....	26
	3.10.15 Behaviour of Alarms after a Power Cycle.....	26
<b>3.11</b>	<b>Pressure Transducer Calibration .....</b>	<b>27</b>
	3.11.1 Calibration of a Pressure Transducer fitted with an internal shunt resistor.....	27
	3.11.2 Calibration of pressure transducers with an external shunt resistor .....	27
	3.11.3 Calibration of an amplified pressure transducers with an internal shunt resistor .....	27

3.11.4	Calibration of pressure transducer connected to the secondary input .....	27
<b>4.</b>	<b>CONTROLLER BLOCK DIAGRAM.....</b>	<b>28</b>
<b>5.</b>	<b>CONFIGURATION LEVEL .....</b>	<b>29</b>
<b>5.1</b>	<b>To Select Configuration Level.....</b>	<b>29</b>
<b>5.2</b>	<b>Configuration Level Parameters.....</b>	<b>29</b>
<b>5.3</b>	<b>Configuration - 'P' Codes.....</b>	<b>30</b>
5.3.1	Summary.....	30
5.3.2	Pressure Input Selection.....	31
5.3.3	Shunt Calibration.....	31
5.3.4	Pressure Input Display Update Time.....	31
5.3.5	Secondary Input.....	32
5.3.6	Control Output .....	33
5.3.7	Retransmission.....	34
5.3.8	Alarms .....	35
5.3.9	Logic Input.....	36
5.3.10	Peak Detection .....	36
5.3.11	Line Frequency.....	36
5.3.12	Manual/Auto Start-Up .....	37
5.3.13	Digital Communications .....	38
5.3.14	Pass codes.....	39
5.3.15	Recovery Point.....	39
<b>6.</b>	<b>CONTROL.....</b>	<b>40</b>
6.1.1	Control Algorithm .....	40
6.1.2	Proportional Band ' <i>Pb</i> ' .....	40
6.1.3	Integral Term ' <i>ti</i> ' .....	41
6.1.4	Derivative Term ' <i>td</i> '.....	41
<b>6.2</b>	<b>Tuning.....</b>	<b>42</b>
6.2.1	TUNE Function.....	42
6.2.2	ADAPTIVE Function .....	42
6.2.3	Automatic stand-by:.....	42
<b>6.3</b>	<b>Start up of a Process .....</b>	<b>42</b>
<b>7.</b>	<b>DIGITAL COMMUNICATIONS .....</b>	<b>43</b>
7.1	EIA485 Field Communications Port.....	43
7.2	Modbus/JBus Protocol .....	43
<b>8.</b>	<b>INSTRUMENT CALIBRATION .....</b>	<b>44</b>
8.1	To Access Calibration Mode.....	44
8.2	Error Codes.....	46
8.3	Example 1: To Calibrate the 0-10V Main Input .....	47
8.4	Example 2: To Calibrate the 0-5V Main Input.....	48
8.5	Example 3: To Calibrate the 0-20mA Main Input.....	49
8.6	Example 4: To Calibrate the Control Output (OUT1) - Voltage.....	50
<b>9.</b>	<b>CPI (CONFIGURATION PORT INTERFACE) .....</b>	<b>51</b>
9.1	CPI Adaptor .....	51
9.2	Firmware Update Procedure .....	52
<b>10.</b>	<b>APPENDIX A MODBUS AND JBUS ADDRESSES .....</b>	<b>53</b>
10.1	Multiplier and Decimal figures.....	53
10.2	S2K IEEE floating point notation .....	53
10.3	Level 1 and Level 2 Parameters.....	53
<b>11.</b>	<b>APPENDIX B TECHNICAL SPECIFICATION.....</b>	<b>60</b>
<b>12.</b>	<b>INDEX.....</b>	<b>62</b>

### Issue status of this Manual

Issue 2 makes minor corrections.

Issue 3 updates strain gauge wiring diagram.

## 1. Description

P304c is a microprocessor based pressure and process controller based on the Piccolo range of instruments. It is suitable for use on a wide range of processes including the control and indication of extruder melt pressure.

Two process inputs are available which are user configurable for 350 $\Omega$  strain gauges, voltage or current. A 24Vdc power supply provides the voltage for two or four wire transducers.

Two voltage or mA outputs may be configured for control purposes or for retransmission of process measurements.

Three alarms may be attached to the measured variable to provide indication and interlocks of any out of tolerance condition.

EIA485 3-wire digital communications uses Modbus/Jbus communications.

Configuration and commissioning parameters may be set through the front panel keys (protected by different levels of access).

This manual describes installation, wiring, operation, configuration and calibration of the controller.

### 1.1 Unpacking Your Controller

The package contains:

- P304c controller mounted in its sleeve
- 2 X Panel securing clips
- Installation sheets in English, French, German and Italian
- Panel sealing gasket

### 1.2 Dimensions

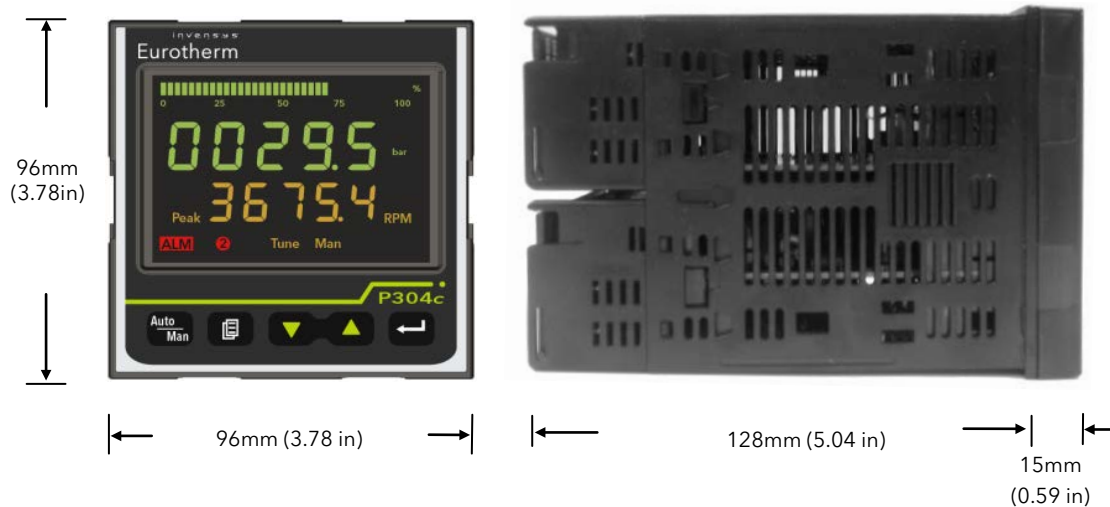

### 1.3 Step 1: Installation

This instrument is intended for permanent installation, for indoor use only, and enclosed in an electrical panel. Select a location which is subject to minimum vibrations the ambient temperature is within 0 and 50°C (32 - 122°F) and operating humidity of 0 to 85% RH non condensing.

The instrument can be mounted on a panel up to 25mm thick.

To ensure panel sealing, mount on a non-textured surface.

Please read the safety information in section 2 before proceeding. An EMC Booklet, part number HA025464, gives further installation information and can be downloaded from [www.eurotherm.co.uk](http://www.eurotherm.co.uk).

#### 1.3.1 Panel Mounting the Controller

The instrument can be fitted into a panel up to 25mm thick.

1. Prepare a cut-out in the mounting panel to the size shown. If a number of instruments are to be mounted in the same panel observe the minimum spacing shown.
2. Carefully remove the panel retaining clips (3) from the sleeve.
3. To achieve panel sealing, make sure the gasket (1) is fitted behind the front bezel of the controller
4. Insert the controller (2) through the cut-out
5. Fit one panel securing clip to the top of the controller sleeve and the second clip diagonally opposite on the underneath of the sleeve in the slots provided
6. Tighten the panel securing clips using a screwdriver to a torque of between 0.3 and 0.4 Nm
7. To remove the controller from its sleeve, ease the latching ears (4) outwards and pull the controller forward out of the sleeve. When refitting ensure that the latching ears click back into place to maintain the panel sealing

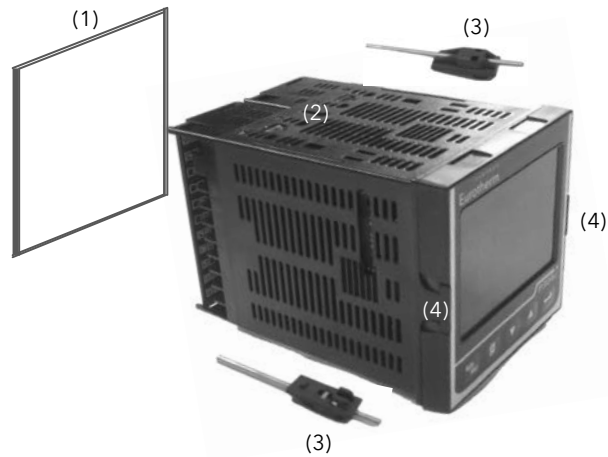

#### 1.3.2 Panel Cut Out Size

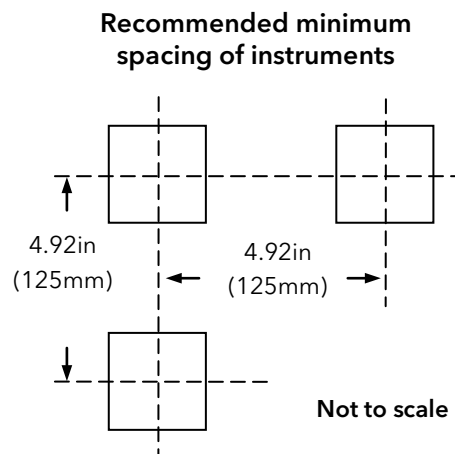
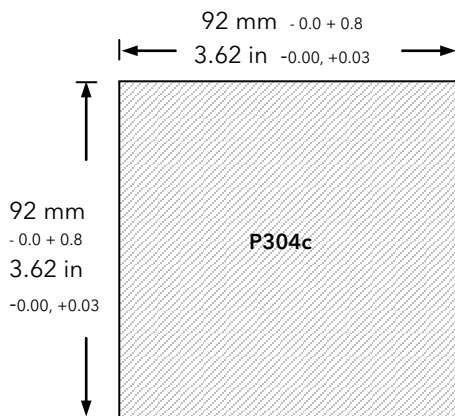

## 1.4 Order Code

	1	2	3	4	5	6
Model Number	Function	Supply Voltage	Second Input	Options	Custom Label	Special

	Model Number	1. Function	2. Power Supply
P304c	¼ DIN controller	CC Pressure controller	VH 100 - 230Vac 50 / 60Hz VL 24Vac / Vdc

3. Second Input	4. Options	5. Custom Label
XXX None	SDXX 24Vdc TPSU + analogue DC retransmission	XXXXXX None
RSP Analogue set point or second PV input (differential pressure)	SD4L 24Vdc TPSU + analogue DC retransmission + RS 485 + 4 dig in	6. Special XXXXXX None

By default the unit is shipped as follows:

- The main input configured for Strain Gauge
- Main Output for voltage control of the process
- Secondary Output (if fitted) as voltage retransmission of the measured variable
- Three alarms. Alarm 1, low with mask at start up. Alarm 2, High. Alarm 3, High.
- Five Digital Inputs. RESET, Alarm + Peak Reset. Digital input 1, Auto/Manual select. Digital input 2, increase output value. Digital input 3, decrease output value. Digital input 4, set the control output to zero.

The defaults can be reconfigured, see section 5.

## 1.5 Step 2: Wiring

### 1.5.1 Rear Terminal Connections

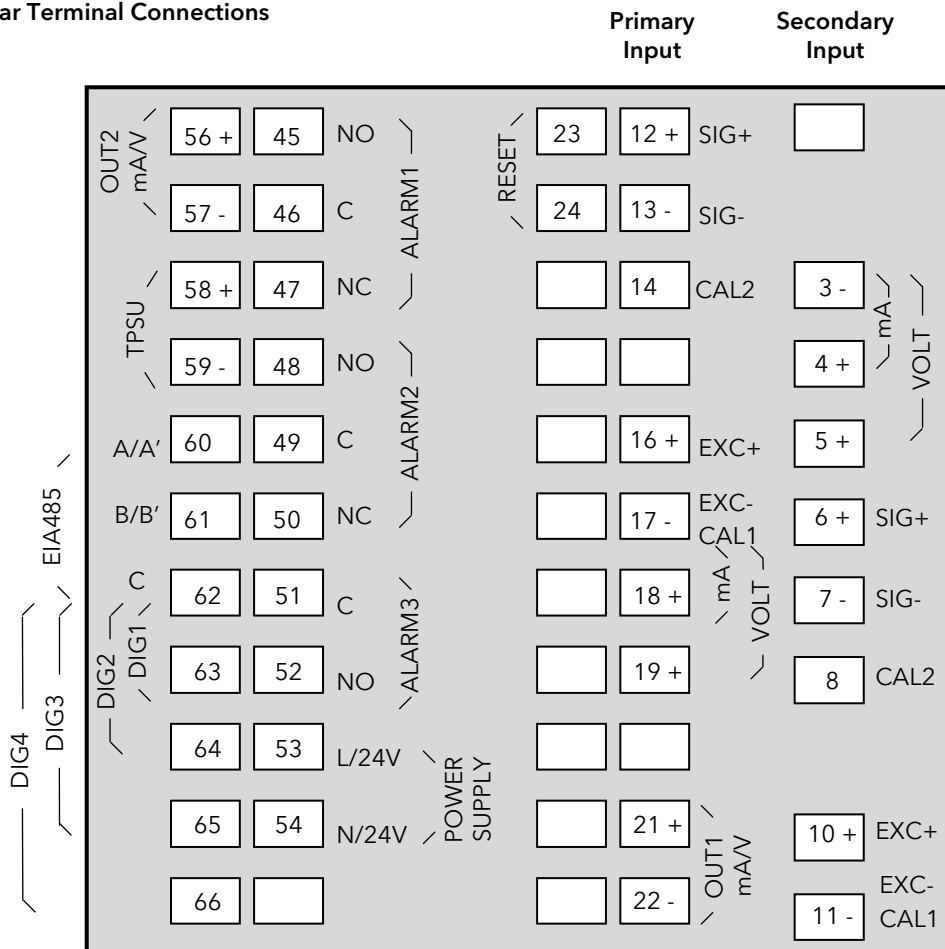

### 1.5.2 Block Diagram and Isolation Boundaries

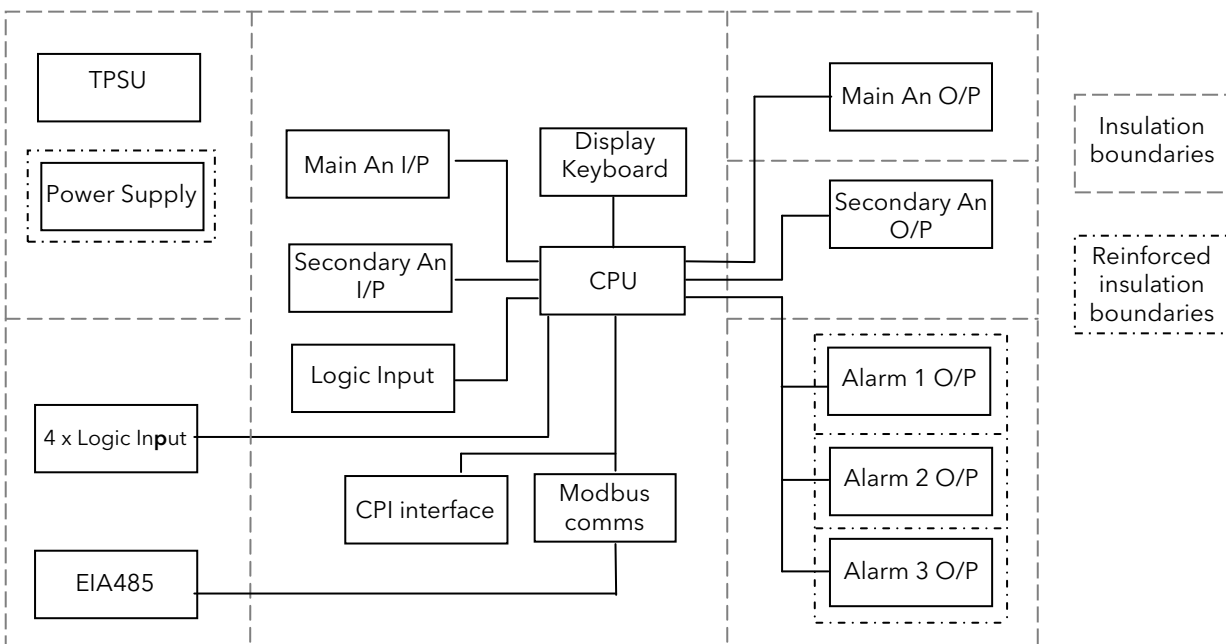

### 1.5.3 Wire Sizes

The screw terminals accept wire sizes from 0.5 to 1.5 mm (16 to 22AWG). Hinged covers prevent hands or metal making accidental contact with live wires. The rear terminal screws should be tightened to a torque of between 0.3 and 0.4 Nm



The specification given in the following sections are a summary only. For full specifications see section 11.

#### 1.5.4 Power Supply

1. Before connecting the instrument to the power line, make sure that the line voltage corresponds to the description on the identification label.
2. Use copper conductors only.
3. For 24V the polarity is not important
4. The power supply input is not fuse protected. This should be provided externally

Recommended external fuse ratings are as follows:-

For 24 V ac/dc, fuse type: T rated 2A 250V

For 100-230Vac, fuse type: T rated 2A 250V.

- A switch or circuit breaker must be included in the building installation
- It shall be in close proximity to the equipment and within easy reach of the operator
- It shall be marked as the disconnecting device for the equipment.

Notes: A single switch or circuit breaker can drive more than one instrument.

An earth (ground) connection is not required.

##### 1.5.4.1 High Voltage Power Supply - Order Code VH

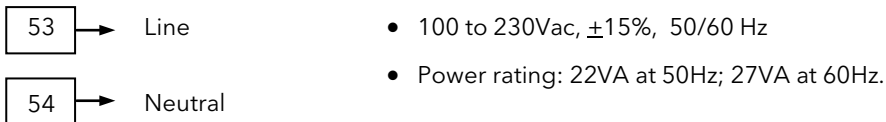

##### 1.5.4.2 Low Voltage Power Supply - Order Code VL

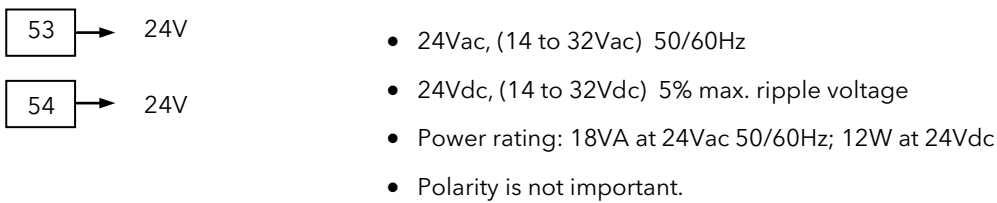

### 1.5.5 Sensor Inputs

#### Precautions

- Do not run input wires together with power cables
- When shielded cable is used, it should be grounded at one point only
- These inputs are isolated

#### 1.5.5.1 Pressure Transducer - Primary Input/Secondary Input

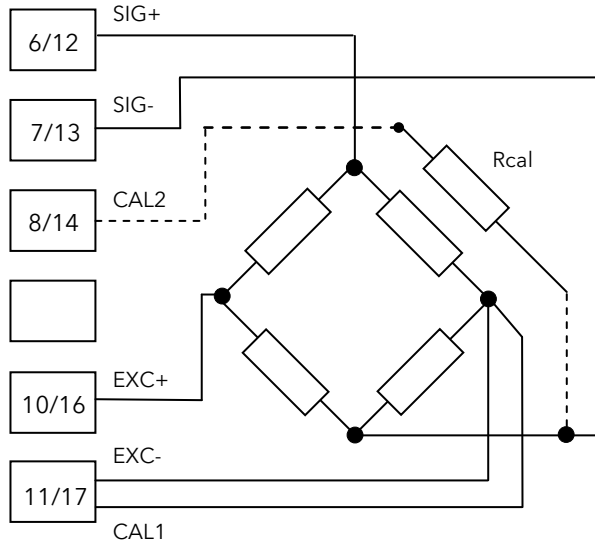

The diagram shows a pressure transducer with internal calibration resistor.

For transducers without an internal resistor connect an external resistor between terminals 13 and 14 (primary input) or 7 and 8 (secondary input).

The resistor is only switched in when calibrating the transducer. See section 3.11.

For transducer terminal numbers, refer to the manufacturers data.

#### 1.5.5.2 2 Wire Transmitter

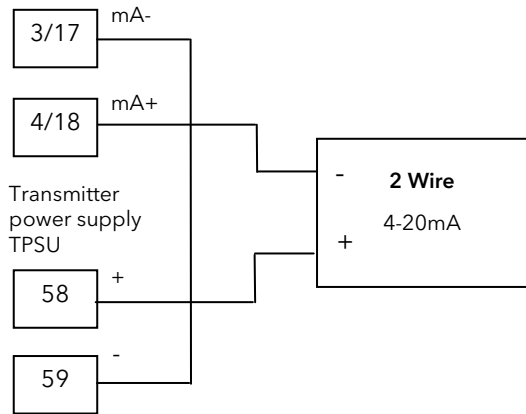

These inputs may be used to measure differential pressure. A typical example measures the pre and post screen pressures in screen changer applications.

#### 1.5.5.3 4 Wire Transmitter

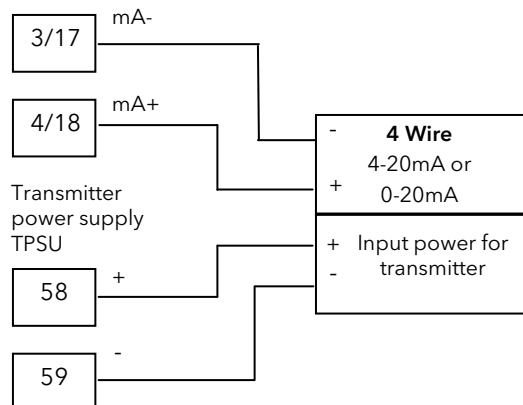

#### 1.5.5.4 mA - Primary Input/Secondary Input

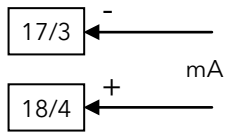

- Ranges: 0-20mA, 4-20mA configurable
- It is not necessary to fit a burden resistor to the mA inputs since this is connected internally.

#### 1.5.5.5 Voltage - Primary Input/Secondary Input

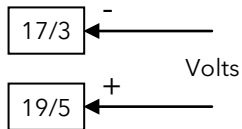

- Ranges: 0-5V, 0-10V configurable

#### 1.5.6 Transmitter Power Supply (TPSU)

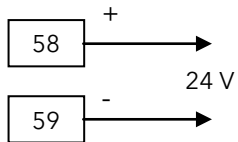

- 24Vdc +/- 2%, 1.5W optional supply for two or four wire transmitters

### 1.5.7 Analogue Outputs

Two analogue outputs are provided. OUT1 is used for control and OUT2 is used for retransmission of the measured value.

Both outputs may be configured using the appropriate 'P' codes (section 5.3).

#### 1.5.7.1 Control Output (OUT1)

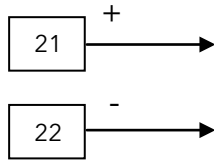

- Opto-isolated from CPU, input and output circuits
- 0/10 VDC min. load 5 k $\Omega$ , with under/over-range capability from -2.5 to 12.5 V (default).
- -10/+10 VDC min. load 5 k $\Omega$ , with under/over-range capability from -12.5 to 12.5 V.
- 0/5 VDC min. load 5 k $\Omega$ , with under/over-range capability from -1.25 to 6.25 V.
- 0/20 mA max. load 500 $\Omega$ , with under/over-range capability from -5 to 25 mA (max. load 400 $\Omega$  over 20 mA).
- 4/20 mA max. load 500 $\Omega$ , with under/over-range capability from 0 to 24 mA (max. load 400 $\Omega$  over 20 mA).
- Resolution: 0.1% in manual mode, 0.03% in automatic mode.
- Scaling: The output control value may be displayed in two modes:
  - from 0.0 to 100.0 % (0.1% resolution)
  - from a low to a high limits selectable from -10000 to 10000.
- Output limits: From 0 to 100 % of full scale; no under-range or over-range is allowed.
- Output filter: Selectable: OFF, 0.4, 1, 2, 3, 4, 5 seconds.

#### 1.5.7.2 Retransmission Output (OUT2)

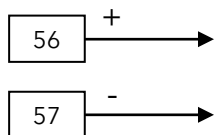

- Opto-isolated from CPU, input and output circuits
- 0/10 VDC min. load 5 k $\Omega$ , with under/over-range capability from -2.5 to 12.5 V (default).
- -10/+10 VDC min. load 5 k $\Omega$ , with under/over-range capability from -12.5 to 12.5 V.
- 0/5 VDC min. load 5 k $\Omega$ , with under/over-range capability from -1.25 to 6.25 V.
- 0/20 mA max. load 500 $\Omega$ , with under/over-range capability from -5 to 25 mA (max. load 400 $\Omega$  over 20 mA).
- 4/20 mA max. load 500 $\Omega$ , with under/over-range capability from 0 to 24 mA (max. load 400 $\Omega$  over 20 mA).
- Resolution: 0.1% of output span.
- Scaling: The retransmission low and high limits are selectable from 0 to pressure input full scale value. The two scaling values may be freely selectable within the above range, this allow to have a direct or reverse output type.
- Output filter: Selectable: OFF, 0.4, 1, 2, 3, 4, 5 seconds

### 1.5.8 Digital Inputs

- Four optional digital inputs are provided for control purposes plus one for reset purposes.
- The interface circuit is opto-isolated with respect to the CPU, analogue inputs and outputs, but not isolated with respect to the EIA485 digital communications.

#### 1.5.8.1 Digital Input 1

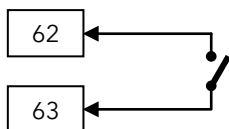

- This contact acts as automatic/manual switch and is only available when the Auto/Manual selection =  $\overline{CnEt}$ , see sections 3.4.1 and 3.6.1.
- Closed selects manual mode
- Open selects automatic mode
- **Note:** A dry contact switch or relay must be fitted to enable the use of Digital Input 2 (DIG2) and Digital Input 3 (DIG3).

#### 1.5.8.2 Digital Input 2

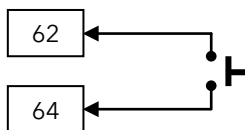

- DIG2 is only available when the Auto/Manual selection =  $\overline{CnEt}$ . See section 3.4.1
- Close the contact to increase the control output value when the controller is in manual mode

#### 1.5.8.3 Digital Input 3

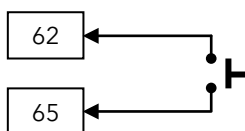

- DIG3 is only available when the Auto/Manual selection =  $\overline{CnEt}$ . See section 3.4.1
- Close the contact to decrease the control output value when the controller is in manual mode

#### 1.5.8.4 Digital Input 4

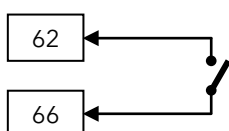

- This contact is used to switch the controller from automatic to manual mode setting the control output to zero.
- Close to transfer from manual to automatic mode. The front panel is inhibited while the user may modify the control output.
- Open to return to automatic mode

#### 1.5.8.5 'Reset' Digital Input

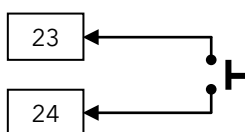

- Contact closure (voltage free)
- It may be keyboard programmable for the following functions using 'P' code P81:
  - alarm reset.
  - peak reset.
  - alarm and peak reset.
  - zero calibration of the primary input.
  - zero calibration of the primary input, alarm and peak reset.
- The access to the parameters by frontal keyboard is inhibited while the zero calibration is running.
- The reset functions (peak and alarm) are level-triggered; it means reset is active as long as the contact is closed.
- The zero calibration function is edge-triggered; it means calibration is started at contact closure.
- Not isolated with respect to analogue inputs.

### 1.5.9 Alarms

There are three standard alarms.

Each alarm is:

- Keyboard programmable using the appropriate 'P' codes for:
  - Process variable / Deviation / Band
  - High / Low / Low masked on start up
  - Auto / Manual reset
  - Hysteresis - adjustable from 0.1% to 10% of span or one LSD (whichever is the greater)
  - Filter: Selectable from OFF, 0.4, 1, 2, 3, 4, 5 seconds.
  - By default relays are de-energised when the alarm is active (failsafe).  
They can be re-configured to be energised in the alarm state see section 3.10.11 'Failsafe mode'.
- Varistor protected for spikes protection

#### 1.5.9.1 Alarm 1

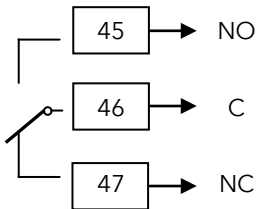

- 1 SPDT 2A maximum @240Vac resistive load

#### 1.5.9.2 Alarm 2

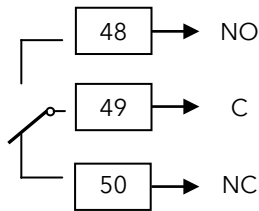

- 1 SPDT 2A maximum @240Vac resistive load

#### 1.5.9.3 Alarm 3

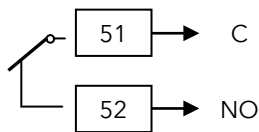

- 1 SPDT solder jumper selectable NO/NC (default NO)  
2A maximum @240Vac resistive load

### 1.5.10 Modbus Serial Communications

Digital communications uses the Modbus protocol EIA485 2-wire.

☺ Cable screen should be grounded at one point only to prevent earth loops.

#### EIA485 Connections

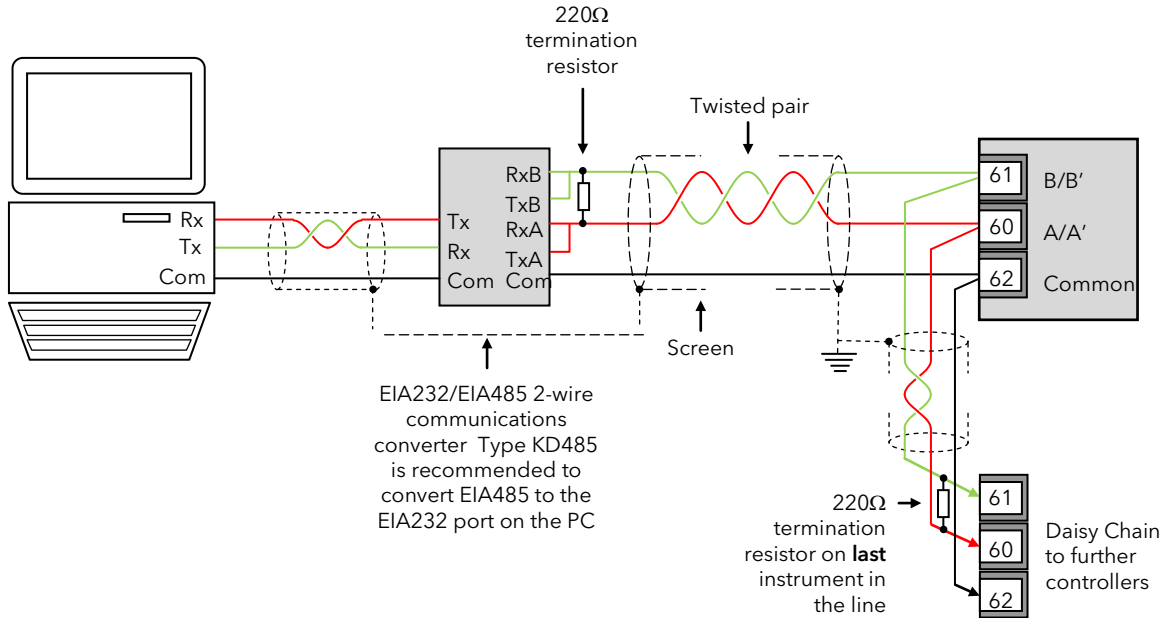

**Note:**

The device physical interface can only support up to 31 devices for each segment. More than 31 devices will require additional buffering. For more details see the Communications Manual HA026230 which can be downloaded from [www.eurotherm.co.uk](http://www.eurotherm.co.uk).

## 2. Safety and EMC Information

This instrument is intended for industrial temperature and process control applications within the requirements of the European Directives on Safety and EMC.

Information contained here is subject to change without notice. While every effort has been made to ensure the accuracy of the information, your supplier shall not be held liable for errors contained herein.

**Safety and EMC** protection can be seriously impaired if the unit is not used in the manner specified. The installer must ensure the safety and EMC of the installation.

This instrument complies with the European Low Voltage Directive 2006/95/EC, by application of safety standard EN 61010.

**Unpacking and storage.** If on receipt, the packaging or unit is damaged, do not install but contact your supplier. If being stored before use, protect from humidity and dust in an ambient temperature range of  $-20^{\circ}\text{C}$  to  $+70^{\circ}\text{C}$ .

**Electrostatic discharge precautions.** Always observe all electrostatic precautions before handling the unit.

**Service and repair.** This instrument has no user serviceable parts. Contact your supplier for repair.

**Cleaning.** Isopropyl alcohol may be used to clean labels. Do not use water or water based products. A mild soap solution may be used to clean other exterior surfaces.

**Electromagnetic compatibility.** This instrument conforms to the essential protection requirements of the EMC Directive 2004/108/EC, by the application of a Technical Construction File. It satisfies the general requirements of the industrial environment defined in EN 61326-1.

**Caution: Charged capacitors.** Before removing an instrument from its sleeve, disconnect the supply and wait at least two minutes to allow capacitors to discharge. Avoid touching the exposed electronics of an instrument when withdrawing it from the sleeve.

**Symbols.** If symbols are used on the instrument, they have the following meaning:



Refer to manual.



Risk of electric shock.



Take precautions against static.



Protected by DOUBLE INSULATION

**Installation Category and Pollution Degree.** This unit has been designed to conform to EN61010 standard installation category and pollution degree, defined as follows:-

- **Installation Category II (CAT II).** The rated impulse voltage for equipment on nominal 230V supply is 2500V.
- **Measurement Category I (CAT 1).** All measurement circuits withstand a 1500V rated impulse voltage.
- **Pollution Degree 2.** Normally only non-conductive pollution occurs. However, a temporary conductivity caused by condensation must be expected.

**Personnel.** Installation must only be carried out by suitably qualified personnel

Enclosure of Live Parts. To prevent hands or metal tools touching parts that may be electrically live, the unit must be installed in an enclosure

**Wiring.** It is important to connect the unit in accordance with the data in this sheet. Always use copper cables. Wiring must comply with all local wiring regulations, i.e. UK, the latest IEE wiring regulations, (BS7671), and USA, NEC Class 1 wiring methods.

**Voltage rating.** The maximum voltage applied to the relay and logic output terminals must not exceed 230Vac +15%. The controller must not be wired to a three phase supply with an unearthed star connection.

**Electrically Conductive pollution** e.g. carbon dust, MUST be excluded from the unit enclosure. Where necessary, fit an air filter to the air intake of the enclosure. Where condensation is likely, include a thermostatically controlled heater in the enclosure.

**Grounding of the temperature sensor shield.** In some installations it is common practice to replace the temperature sensor while the controller is still powered up. Under these conditions, as additional protection against electric shock, we recommend that the shield of the temperature sensor is grounded. Do not rely on grounding through the framework of the machine.

**Installation Requirements for EMC.** To comply with European EMC directive certain installation precautions are necessary:-

- General guidance. Refer to EMC Installation Guide, Part no. HA025464.
- Relay outputs. It may be necessary to fit a suitable filter to suppress conducted emissions.

**Table top installation.** If using a standard power socket, compliance with commercial and light industrial emissions standard is usually required. To comply with conducted emissions standard, a suitable mains filter must be installed.



### 3. Switch On

Whenever the controller is switched on (powered up) it will start in a diagnostic mode lasting for a few seconds. The diagnostic display illuminates all bars of each character and every beacon, followed briefly by the firmware version number and the instrument type (P304c).

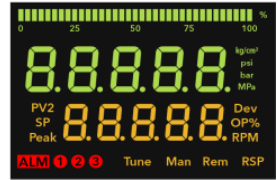

#### 3.1 Operator Display

The controller then opens in Operator level and a typical view is shown below.

**Bar Graph** - measured variable.

Alarm setpoint values are displayed as missing or present bars.

First segment blinks for pressure lower than zero.

Last segment blinks for pressure greater than full scale value.

**Measured Value**

**Selected parameter**

The lower display shows a choice of:

**SP** - Setpoint

**Dev** - Deviation

**OP%** - Output power

**RPM** - Output value scaled to RPM

**Peak** - peak value



**Units**  
kg/cm<sup>2</sup>, psi, bar, MPa

**Status indication**

##### 3.1.1 Status Indication

The status beacons shown below are illuminated to show the current status of the system.



Any alarm active (red)

Alarm 1, 2 or 3 active

Tuning Algorithm flashing = first step activated lit = second step activated

Manual mode selected

Device controlled by serial link

Remote setpoint selected

##### 3.1.2 Keyboard

The keyboard consists of five push-buttons, labelled as follows:

Auto/Man	Press for more than 1 second to switch between Automatic and Manual mode. Automatic mode means normal closed loop control; Manual means the output can be raised or lowered manually using the  or  keys.
PAGE	Press for more than 4 seconds to select the level of operation (see section 3.3) . During parameter modification it is used to <b>scroll back</b> to the previous parameter without storing the parameter changes.
SCROLL	During parameter modification it is used to <b>scroll forward</b> to the next parameter and to store the parameter changes.
	Decrement or modify a parameter value. In manual mode it is used to decrement the output value. When pressed for more than 3 seconds in automatic mode it is used to access and to decrease the set point parameter.
	Increment or modify a parameter value. In manual mode it is used to increment the output value. When pressed for more than 3 seconds in automatic mode it is used to access and to increase the set point parameter. When pressed for less than 3 seconds in automatic mode it is used to switch the lower display between set point value ( <b>SP</b> ), deviation value ( <b>Dev</b> ), output value ( <b>OP%</b> ), output value ( <b>RPM</b> ) and peak value ( <b>Peak</b> ) (if this function is enabled). At power-on the lower display shows the set point value if the automatic mode is selected, or the output value in manual mode
+	To reset the stored peak value and to reset the alarms. This function is disabled when the device is controlled by serial link.
+  or  +	Jump to max or min parameters value when instrument is in manual mode.
+  or  +	Used only at power-up when the instrument detects a parameter error; see the "ERROR CODES" section 8.2.
Note:	Actions which require two or more pushbuttons to be pressed must follow exactly the pushbutton sequence shown.

### 3.1.3 Example - To Display Selected Parameters

Press  to select in turn **SP**, **Dev**, **OP%**, **RPM**, **Peak**.

These are shown lower display and have the following meanings:

<b>SP</b>	The value of the setpoint is displayed. If <b>Lr.SP</b> in the Level 2 list = <b>Loc</b> , the local setpoint value (which is set by selecting SP in the Level 1 or Level 2 list) is displayed. If <b>Lr.SP</b> in the Level 2 list = <b>rEn</b> , the setpoint value is derived from an external mA/voltage source connected to terminals 3 and 4/5. The display also shows RSP in the bottom right hand corner. Note: this assumes that the secondary input is fitted and configured accordingly, see 'P' codes P11 to P24, section 5.3.
<b>Dev</b>	This is the difference between the setpoint and the measured value, i.e. deviation (or error).
<b>OP%</b>	This is the current output power level demand in % of the control output.
<b>RPM</b>	This is the speed of the drive in an extruder application
<b>Peak</b>	The peak value that the measured variable has achieved between start of the process (instrument powered up) and a reset.

## 3.2 Open Indication

If the error message "**OPEN**" is displayed it is due to one or more of the following conditions:



- A/D converter saturation
- input current lower than 0.8 mA (for 4-20 mA inputs)
- pressure input lower than -25% or higher than 125% of full scale value
- "+SIG" or "-SIG" unconnected wire for strain gauge input
- remote set point input lower than -1% or higher than 101% of full scale value

## 3.3 Levels of Operation

There are three levels of operation.

- **Level 1** **LEU1** This is designed for day to day operation so access to these parameters is not protected by a passcode.
- **Level 2** **LEU2** Parameters available in level 1 are also available in level 2. Level 2 contains a full set of parameters for commissioning purposes and more detailed operation. Level 2 can be protected by a passcode.
- **Configuration** **[onF]** Configuration level sets all features of the instrument and is carried out using a list of '**P' codes**. Each P code is associated with a particular feature of the instrument such as Input Type, Ranging, Outputs, Alarms, Digital Communications, etc. Configuration level can be protected by a passcode.

When Configuration level has been entered, two further levels may be selected as follows:-

Press and hold the  button again for about 4 seconds until the **GoTo** message is shown. Then press the  or  button to select the Instrument Calibration level:-



- **Instrument calibration** **[CAL]** The instrument is supplied with all fitted circuits fully calibrated. Furthermore field fitted circuits do not require calibration since these boards are shipped from the factory full calibrated. However, this level is available to allow input and output circuits to be field calibrated if necessary. See section 8 for details.

When the desired level is selected press  button to confirm and to enter the level.

### 3.4 Level 1 Operation



At switch on the instrument enters Level 1.

Press  to scroll through a list of parameters available in this level.

Press  or  to adjust an analogue value or a digital enumeration, provided that the parameter is not read only or has been locked in other levels.

#### 3.4.1 Level 1 Parameters

For day to day operation the following list of parameters are available (depending on configuration).

Mnemonic (shown in the lower display)	Name	Availability	Explanation
<i>SP</i>	SETPOINT	Always	Range SP.LO to SP.Hi. (set in Level 2)
<i>ALMAS</i>	ALARMS MASK RESET	Only if one or more alarms are configured with mask at start up	Use  or  to switch the upper display from <i>OFF</i> to <i>RESET</i> , then press  to restore the alarm mask. See section 3.10.8.
<i>A-M</i>	AUTO/MANUAL SELECTION	Only if the external keyboard is fitted	Select <i>LOCAL</i> for front button operation. Select <i>EXT</i> for external control. This may be selected by the Digital inputs on terminals 62 to 66 Default = <i>LOCAL</i>
<i>AL1</i>	ALARM 1 THRESHOLD	Only if P61 ≠ OFF	Used to set the point at which the alarm operates. Range from 0 to pressure input full scale value for process and band alarm.
<i>AL2</i>	ALARM 2 THRESHOLD	Only if P65 ≠ OFF	From - pressure input to + pressure input full scale values for deviation alarm.
<i>AL3</i>	ALARM 3 THRESHOLD	Only if P69 ≠ OFF	The high limit may be expanded to 110% of span. All three alarms are configured by default and are set to - AL1 5%, AL2 60%, AL3 80% of range. They can be disabled in configuration level.
<i>P1,VAL</i>	PRIMARY PRESSURE INPUT VALUE	Only if P11 ≠ OFF and P12 = <i>d, FFP</i>	This is read only and indicates the pressure measured if the transducer is connected to the primary input terminals.
<i>S1,VAL</i>	SECONDARY PRESSURE INPUT VALUE		This is read only and indicates the pressure measured if the transducer is connected to the secondary input terminals.

#### 3.4.2 Example 1 - To Set Alarm 1 Threshold

Press  until *AL1* is displayed

The current alarm level is shown in the upper (green) display.

Press  to raise the alarm value

Press  to lower the alarm value

Press  to confirm the new value.



The marker bar in the bar graph will also move to the new position.

Alarm 2 and Alarm 3 can be adjusted in a similar way.

### 3.4.3 Example 2 - To Adjust the Output Level in Manual Mode

The output voltage or current can be raised or lowered manually. See also section 3.8.

Select Manual Mode. This can be done in one of two ways:

1. With the parameter AUTO/MANUAL SELECTION, *A-M*, set to *LOCAL*, press the  button on the front panel to select Manual operation. This button toggles between Auto and Manual.  
The **Man** beacon will be shown. The lower display will indicate the current power level from 0.0 to 100.0%.  
Press  or  to raise or lower the output level.
2. With the parameter AUTO/MANUAL SELECTION, *A-M*, set to *EXT*, Manual can be selected by closing an external contact connected to Digital Input 1 (terminals 62 and 63).  
The **Man** beacon will be shown. The lower display will indicate the current power level from 0.0 to 100.0%.  
Close a contact connected to Digital Input 2 (terminals 62 and 64) to raise the power level.  
Close a contact connected to Digital Input 3 (terminals 62 and 65) to lower the power level.

The actual voltage or current output on terminals 21 and 22 is adjusted continuously while the raise or lower button is pressed.

**Note:** P code P87 affects the transfer from manual to auto mode.

If P87 is set to *bump* (bumpless), the switch from manual to auto does not affect the control setpoint. The controller initially keeps the output value and then the control algorithm acts on the output value in order to control the process automatically.

If P87 is set to *SP* the switch from manual to auto causes the control setpoint to assume the current process value. The control algorithm then takes over to maintain control at this new setpoint. This is used when the operator - using manual mode - drives the process to a desired level before switching the controller to auto mode to maintain this value. It is typically used for fast processes such as pressure control and for setting up an extruder. It is not useful for slow processes such as temperature control.

---



#### Warning:





**Care must be taken using Manual mode to ensure that the output level remains within the limits of the process.**

---

## 3.5 To Select Other Levels of Operation

To change the operating mode, follow the steps below:

1. Press and hold  until the lower display shows "Go to" in the lower display (approximately 4 seconds)
2. Press  or  to select the desired operating level on the upper display:
 



<i>LEu1</i>	Normal operative mode Level 1
<i>LEu2</i>	Normal operative mode Level 2
<i>CONF</i>	Configuration level
3. Confirm the choice by pressing .
4. Enter the passcode (if configured) using  or  *LEu2* default = 2. *CONF* default = 4.
5. Press  to accept the value. If passcodes are not configured the selected level will be entered at 3 above.

### 3.6 Level 2 Operation





Level 2 parameters also include Level 1 parameters.

To select a parameter:-

Press  to scroll through a list of parameters.

Press  or  to adjust an analogue value or a digital enumeration, provided that the parameter is not read only or has been locked in configuration level.

#### 3.6.1 Level 2 Parameters

Mnemonic Shown in the lower display	Parameter	Availability	Notes	Further Information
<i>SP</i>	SETPOINT	Always	Range SP.LO to SP.Hi.	
<i>AL MRS</i>	ALARMS MASK RESET	Only if one or more alarms are configured with mask at start up	Use  or  to switch the upper display from <i>OFF</i> to <i>RESET</i> , then press  to restore the alarm mask.	Section 3.10.8
<i>A-M</i>	AUTO/MANUAL SELECTION	Only if the external keyboard is fitted	Select <i>LOCAL</i> for front button operation. Select <i>EXT</i> for external control. This may be selected by the Digital inputs on terminals 62 to 66 Default = <i>LOCAL</i>	Auto/Manual mode is described in section 3.8
<i>LrSP</i>	LOCAL/REMOTE SET POINT SELECTION	If P12 = <i>rSP</i>	This shows the status of the local/remote setpoint selection. <i>LOC</i> - the setpoint is adjusted using the front panel buttons  or  <i>REN</i> - the setpoint is adjusted externally. The last selection is restored at power up. Default = <i>LOC</i>	'P' code P12 section 5.3.5
<i>SPLo</i>	SET POINT LIMIT LOW	Always	Prevents the setpoint from being set too low in Operator level 1. Range 0 to <i>SPHi</i> Default = 0	
<i>SPHi</i>	SET POINT LIMIT HIGH	Always	Prevents the setpoint from being set too high in Operator level 1. Range <i>SPLo</i> to P3 Default = P3	
<i>SPrr</i>	SET POINT RAMP	Always	This parameter is used to limit the rate of change of the local set point. It is active also when switching from local to remote set point and vice versa. When the ramp value meets the remote set point input signal, the ramp function is disabled to allow the controller set point to match exactly the analogue input. Range from 1 to 999 engineering units per second (with a resolution multiplier according to Full Scale Value) and then OFF (step change). Default = OFF.	
<i>AL 1</i>	ALARM 1 THRESHOLD	If P61 ≠ OFF	Used to set the point at which the alarm operates. Range from 0 to pressure input full scale value for process and band alarm. From - pressure input to + pressure input full scale values for deviation alarm. The high limit may be expanded to 110% of span. Default AL1 5%, AL2 60%, AL3 80% of range.	Section 3.9
<i>ALHS</i>	ALARM 1 HYSTERESIS	If P61 ≠ OFF	Range 0.1 to 10.0%. Default = 1.0.	
<i>AL2</i>	ALARM 2 THRESHOLD	If P65 ≠ OFF	See AL1	
<i>AL2HS</i>	ALARM 2 HYSTERESIS	If P65 ≠ OFF	Range 0.1 to 10.0%. Default = 1.0.	
<i>AL3</i>	ALARM 3 THRESHOLD	If P69 ≠ OFF	See AL1	

Mnemonic Shown in the lower display	Parameter	Availability	Notes	Further Information
<b>A3HS</b>	ALARM 3 HYSTERESIS	If P69 ≠ OFF	Range 0.1 to 10.0%. Default = 1.0.	
<b>P1 uAL</b>	PRIMARY PRESSURE INPUT VALUE	Only if P11 ≠ OFF and P12 = <b>d1 FFP</b>	See 'Level 1 Parameters'	
<b>S1 uAL</b>	SECONDARY PRESSURE INPUT VALUE			
<b>LoC</b>	ZERO CALIBRATION	Always	Use <b>▼</b> or <b>▲</b> to switch upper display from <b>OFF</b> to <b>On</b> . Then press <b>↵</b> to start the calibration. It is also possible to select <b>CLEAR</b> to delete field calibration and restore factory calibration. Default: Zero calibration: 0 Span calibration: Full scale for linear input; 33.3mV for strain gauge.	See also section 3.11
<b>Lo2C</b>	ZERO CALIBRATION FOR SECONDARY INPUT	If P11 ≠ OFF & P12 = <b>d1 FFP</b>		
<b>Hi C</b>	SPAN CALIBRATION	Always		
<b>Hi 2C</b>	SPAN CALIBRATION FOR SECONDARY INPUT	If P11 ≠ OFF & P12 = <b>d1 FFP</b>		
<b>TUNE</b>	TUNE	Always	In manual mode start the TUNE algorithm. In auto it enables the ADAPTIVE function. Default = OFF	See section 6.2
<b>Pb</b>	PROPORTIONAL BAND	Always	Range 1 to 10000%. Default 100.	
<b>t1</b>	INTEGRAL TIME	Always	Range 0.1 to 99.9s. Default = 5.0.	
<b>td</b>	DERIVATIVE TIME	Always	Range 0.0 to 99.9s. Default = 0.0.	
<b>i P</b>	INTEGRAL PRE LOAD	Always	Range 0.0 to 100%. Default = 50.0.	
<b>oPHi</b>	CONTROL OUTPUT LIMITER	Always	Range 10.0 to 100.0. Default = 100.0.	
<b>Ctrl</b>	TYPE OF CONTROL	Always	PI or PID. Default = PI.	
<b>Ctrl FL</b>	FILTER FOR DISPLAY AND CONTROLLER	Always	Range OFF, 0.5, 1, 2, 4, 8, 16 sec. Default = 1 sec.	
<b>ASb</b>	AUTOMATIC STAND-BY	Always	Range On or OFF. Default = OFF	
<b>ASbPL</b>	AUTOMATIC STAND-BY PRESSURE LOW LIMIT	If <b>ASb</b> = On	Range 0 to 15%. Default = 5%.	
<b>ASbrt</b>	AUTOMATIC STAND-BY RECOVERY TIME	If <b>ASb</b> = On	Range 0 to 60 then <i>OFF (output is frozen)</i> .	
<b>A1FL</b>	ALARM 1 FILTER	If P61 ≠ OFF	Time constant of the alarm filter Range OFF, 0.4, 1, 2, 3, 4, 5 sec. Default = 0.4 second	
<b>A2FL</b>	ALARM 2 FILTER	If P65 ≠ OFF		
<b>A3FL</b>	ALARM 3 FILTER	If P69 ≠ OFF		
<b>roFL</b>	RETRANSMISSION OUTPUT FILTER	If P55 ≠ OFF Shown when starting tune in manual mode	Time constant of the retransmission output filter Range OFF, 0.4, 1, 2, 3, 4, 5 sec. Default = 0.4 seconds	
<b>ALt</b>	TIME OF TUNE FUNCTION	During the automatic calculation of the filter time constant the upper display shows the time constant selected by the algorithm. During the process analysis the upper display shows the elapsed time from the step change; the time format is mm.ss (minutes and seconds). The maximum time is 500 minutes after which auto tuning will be disabled.		These parameters apply when the <b>TUNE</b> function is active. See section 6.2 for further details.
<b>ALStP</b>	STEP FOR TUNE FUNCTION	Value of the step change used by the auto tuning function to estimate the process parameters. Default value = 10.0%		

<b>LEP</b>	AUTOMATIC SELECTION OF THE INTEGRAL PRE LOAD VALUE	<p>Setting this parameter to <b>Auto</b> causes the controller to calculate the integral pre load value using the set point and process gain values.</p> <p>The process gain value is estimated during the auto tuning function, then the automatic calculation of the integral pre load value is reliable only after a tuning trial.</p> <p>In <b>Auto</b> the integral pre load value may be read but not modified by the front push-buttons.</p> <p>Setting this parameter to <b>MAN</b> (manual) causes the controller to reload the former keyboard selected integral pre load value.</p> <p>Default value = <b>MAN</b> (manual)</p>	 'P' codes are found in section 5.2.
<b>LEFL</b>	AUTOMATIC SELECTION OF THE FILTER TIME CONSTANT	<p>Setting this parameter to <b>Auto</b> causes the tuning function to perform a search for the best filter time constant before applying the power change.</p> <p>The 'Tune' beacon will flash at a fast rate while the device is searching for the best time constant.</p> <p>Default value = <b>MAN</b> (manual)</p>	
<b>LELD</b>	PROCESS TIME DELAY	<p>Read-only value of the process time delay as estimated by tuning function.</p> <p>Default is not applicable. The display shows zero until the first tune trial.</p>	
<b>LEPL</b>	PROCESS TIME CONSTANT	<p>Read-only value of the process time constant as estimated by tuning function.</p> <p>Default is not applicable. The display show zero until the first tune trial.</p>	
<b>LEPG</b>	PROCESS GAIN	<p>Read-only value of the process gain as estimated by the tuning function.</p> <p>The value is stored in non volatile memory because it is used in automatic compute of the integral pre load value.</p> <p>Default value = 1.00</p>	
<b>LEL1</b>	START TIME OF TUNE FUNCTION	<p>This read-only value is displayed when the tuning function is started to collect data for transient response analysis.</p> <p>Default is not applicable. The display shows zero until the first tune trial.</p>	
<b>LEL2</b>	STOP TIME OF TUNE FUNCTION	<p>This read-only value is displayed when the auto tuning function has finished to collect data for transient response analysis.</p> <p>Default is not applicable. The display shows zero until the first tune trial.</p>	
<b>LEL5</b>	ADAPTIVE STEP	<p>This read-only value shows the internal step number used by the adaptive algorithm.</p>	

### 3.7 To Return to Level 1

1. Press and hold  until the lower display shows "**Auto**" in the lower display (approximately 4 seconds)
2. Press  or  to select **LEL1**

### 3.8 Auto / Manual Mode



**Auto mode** is the normal operation where the output is adjusted automatically by the controller in response to changes in the measured value (pressure).

In Auto mode all the alarms and the other functions are operational.

**Manual mode** means that the controller output power is manually set by the operator. The input sensor is still connected and reading the temperature but the control loop is 'open'.

In Manual mode all the alarms are operational.

In manual mode the '**Man**' indication is lit.

The power output can be continuously increased or decreased using the  or  buttons or from external contact inputs if configured.



**In an extruder melt pressure control application it is usual to start the extruder in manual mode and to bring the process to stable conditions before switching to automatic when the controller will ramp to setpoint in a controlled manner.**

**It is strongly recommended not to start this type of motor speed process in automatic mode.**

**However, in some other non motor control processes automatic start up is desirable.**

**It is the responsibility of the user to determine which is desirable for the process under control.**

---

☺ The transfer from Auto to manual mode may be chosen as 'bumpless' or setpoint ('P' code P87).

The default is bumpless (**bumpless**) which means the output will remain at the current value at the point of transfer. If setpoint (**SP**) is selected the current setpoint is used when changing from manual to auto and the process is maintained at this level by the PID algorithm.

See also the example in section 3.4.3

In Level 2, the Auto/Manual function can be controlled from the front panel buttons by selecting **LoCAL** or through an external keyboard by selecting **Ctrl**.



### 3.9 Alarms

**Alarms** are used to alert an operator when a pre-set level has been exceeded. The threshold value can be set in Level 1 (or 2) by the alarm setpoint parameters *AL1*, *AL2* or *AL3*.

They are indicated by lighting the alarm number **1**, etc. and the red **ALM** beacon in the display.

Alarm 1 operates the change-over relay connected to terminals 45, 46 and 47.

Alarm 2 operates the change-over relay connected to terminals 48, 49 and 50.

Alarm 3 operates the normally closed relay connected to terminals 51 and 52.

The alarm relays may be energised or de-energised in alarm as set by the Fail Safe mode described below.

Each alarm can be configured using 'P' codes as follows:-

• Off / Process / Deviation / Band	(P61 - Alarm 1; P65 - Alarm 2; P69 - Alarm 3)
• High / Low / Low inhibited on start up	(P62 - Alarm 1; P66 - Alarm 2; P70 - Alarm 3)
• Auto / Latching	(P63 - Alarm 1; P67 - Alarm 2; P71 - Alarm 3)

### 3.10 Definition of Alarm Types

Alarm types are configured using two parameters, e.g. P61 and P62 for Alarm 1 as shown in the table above.

Alarm types are illustrated using examples in the sections below.

#### 3.10.1 Process High

An alarm will activate if the measured value exceeds an absolute high value set by the alarm threshold.

The alarm will reset when the measured value falls below the value set by the hysteresis parameter.

**Example:**

Alarm 1 = Process high (set by P61 and P62).

Controller input range = 3000psi (set by P3).

Alarm threshold = 2000psi, set in Level 2 by AL1. (Note: the alarm threshold can be set between 0 and 3300).

Alarm hysteresis = 1.0% of controller input range i.e. 30psi.

The alarm will activate when the input level rises above 2000psi.

The alarm will de-activate when the input level drops below 1970psi.

This is shown graphically for a rising and falling input signal (and assumes the alarm is not a latching type).

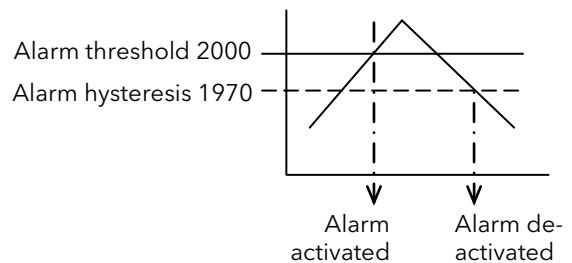

#### 3.10.2 Process Low

An alarm will activate if the measured value exceeds an absolute low value set by the alarm threshold.

**Example:**

Alarm 1 = Process low (set by P61 and P62).

Controller input range = 3000psi (set by P3).

Alarm threshold = 700psi, set in Level 2 by AL1. (Note: the alarm threshold can be set between 0 and 3300).

Alarm hysteresis = 1.0% of controller input range i.e. 30psi.

The alarm will activate when the input level falls below 700psi.

The alarm will de-activate when the input level rises above 730psi.

This is shown graphically for a rising and falling input signal (and assumes the alarm is not a latching type).

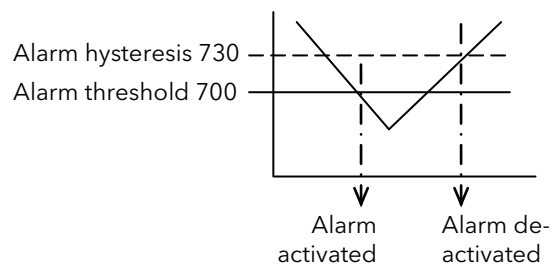

### 3.10.3 Band High

This alarm is used to indicate when the PV is outside the normal working high and low range.

**Example:**

Alarm 1 = Band High (**bAnd** set by P61 and **Hi** set by P62).

Controller input range = 3000psi (set by P3).

Alarm threshold (**AL 1**) = 500psi (Note: the alarm threshold can be set between 0 and 3300).

Alarm hysteresis (**A 1HS**) = 1.0% of controller input range i.e. 30psi.

The alarm will activate when the input level rises above 2500psi (SP + AL1).

The alarm will de-activate when the input level drops below 2470psi (SP + AL1 - A1.HS).

The alarm will activate when the input level falls below 1500psi (SP - AL1).

The alarm will de-activate when the input level rises above 1530psi (SP - AL1 + A1.HS).

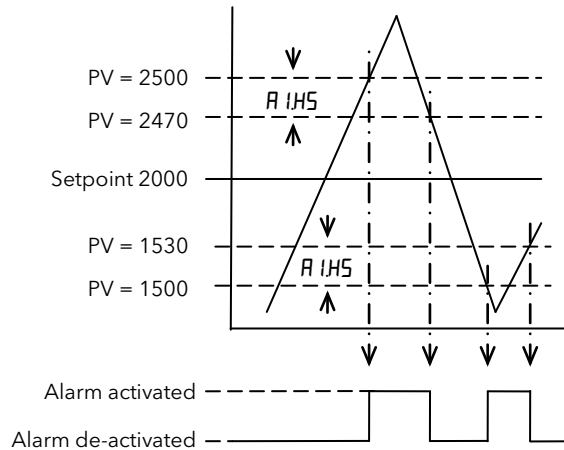

This is shown graphically for a rising and falling input signal (and assumes the alarm is not a latching type).

### 3.10.4 Band Low

This alarm is used to indicate when the PV is inside the normal working high and low range.

**Example:**

Alarm 1 = Band Low (**bAnd** set by P61 and **Lo** set by P62).

Controller input range = 3000psi (set by P3).

Alarm threshold (**AL 1**) = 500psi (Note: the alarm threshold can be set between 0 and 3300).

Alarm hysteresis (**A 1HS**) = 1.0% of controller input range i.e. 30psi.

The alarm will activate when the input level rises above 1500psi (SP - AL1).

The alarm will de-activate when the input level rises above 2530 (SP + AL1 + A1.HS).

The alarm will activate when the input level falls below 2500psi (SP + AL1).

The alarm will de-activate when the input level falls below 1470 (SP - AL1 + A1.HS).

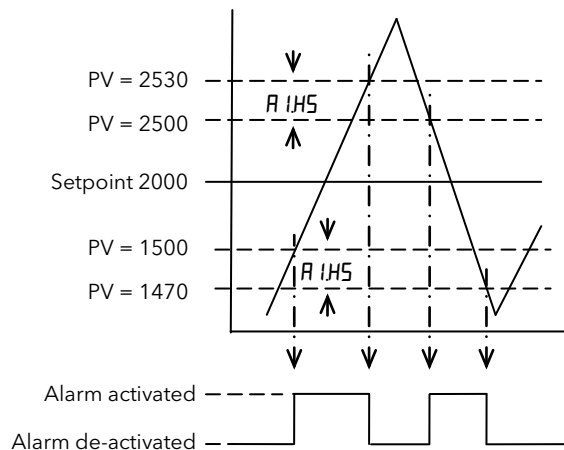

This is shown graphically for a rising and falling input signal (and assumes the alarm is not a latching type).

### 3.10.5 Deviation High

The controller will indicate an alarm if the error value exceeds a high limit set by the alarm threshold.

**Example:**

Alarm 1 = Deviation High (**dEU** set by P61 and **HI** set by P62).

Controller input range = 3000psi (set by P3).

Alarm threshold (**AL1**) = 500psi (Note: the alarm threshold can be set between -3000 and 3300).

Alarm hysteresis (**A1.HS**) = 1.0% of controller input range i.e. 30psi.

The alarm will activate when the input level rises above 2500psi (SP + AL1).

The alarm will de-activate when the input level drops below 2470psi (SP + AL1 - A1.HS).

This is shown graphically for a rising and falling input signal (and assumes the alarm is not a latching type).

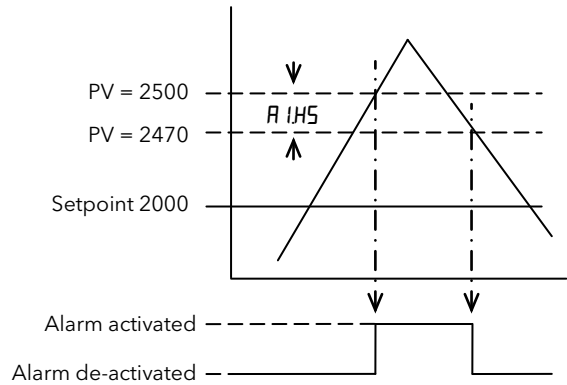

### 3.10.6 Deviation Low

The controller will indicate an alarm if the error value is within a low limit set by the alarm threshold.

**Example:**

The example is the same as the above.

The alarm will activate when the input level is below 2500psi (SP + AL1).

The alarm will de-activate when the input level rises above 2530psi (SP + AL1 + A1.HS).

This is shown graphically for a rising and falling input signal (and assumes the alarm is not a latching type).

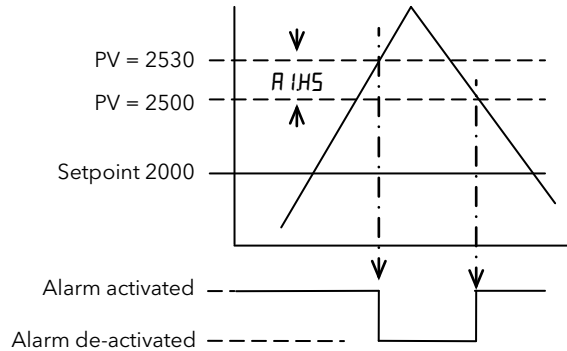

### 3.10.7 Alarm Mask at Start up

Alarm mask at start up is used to inhibit the activation of an alarm during start up of the process. When the process has reached steady state conditions and has achieved the safe state defined by the alarm threshold the mask is removed. Only then will an alarm be triggered if the process exceeds the threshold.

### 3.10.8 Alarm Mask Reset

The alarm mask may be restored using the keyboard parameter (*AL MRS*) available in Levels 1 & 2. Moreover the alarm mask of deviation and band alarms is restored at set point change and during set point ramp.

### 3.10.9 Alarm Reset Mode

This can be set using 'P' code P63, P67 or P71 as Auto or Latching.

An **auto alarm** does not require acknowledgement. The alarm is no longer active as soon as the alarm condition is removed.

A **latching alarm** continues to be active until both the alarm condition is removed AND the alarm is acknowledged. The acknowledgement can only occur AFTER the condition causing the alarm is removed.

### 3.10.10 Alarm Acknowledgement

An alarm may be acknowledged by closing an external contact on the **RESET** input on terminals 23 and 24 - normally an external pushbutton.

### 3.10.11 Failsafe mode

See 'P' codes P64 - Alarm 1; P68 - Alarm 2; P72 - Alarm - 3.

**Failsafe** - relay coil energized in no alarm condition. This means that if power is removed from the controller the relay will relax to indicate an alarm state, assuming, of course, that power remains on to the external alarm circuitry.

**Non-failsafe** - relay coil energized in alarm condition.

The default condition is failsafe.

### 3.10.12 Threshold

This is the value at which the alarm is to operate and may be set in Levels 1 & 2. Range is from 0 to 110% Full Scale (the threshold may be limited due to the selected full scale value).

### 3.10.13 Hysteresis

Hysteresis is the difference between the point at which the alarm switches 'ON' and the point at which it switches 'OFF'. It is used to provide a definite indication of the alarm condition and to prevent alarm relay chatter. It is particularly useful in conditions where the PV is noisy. Hysteresis set for each alarm in Level 2 from 0.1% to 10.0% of span or 1 Least Significant Digit (whichever is greater).

### 3.10.14 Alarm Filter

A time constant can be added to an alarm to prevent spurious switching in the event of a noisy input signal. It is available in Level 2 for each alarm and is selectable from: OFF, 0.4s, 1s, 2s, 3s, 4s, 5s.

### 3.10.15 Behaviour of Alarms after a Power Cycle

If an alarm is active when the power is switched off and is still active when the power is restored the alarm condition will be detected.

If an alarm is active when the power is switched off and is no longer active when the power is restored no alarm will be detected.

### 3.11 Pressure Transducer Calibration

This section describes how to calibrate the instrument to the particular pressure transducer being used. The instrument should be powered up for at least 15 minutes and allow the transducer to reach operating conditions.

#### 3.11.1 Calibration of a Pressure Transducer fitted with an internal shunt resistor.

Assume the transducer, with no load, is connected to the Primary Input. If the controller has not been configured then carry out the following steps in Configuration Level. If it has been configured then calibration is performed as described below in Level 2.

##### Configure the controller

In configuration level set the relevant 'P' codes for the transducer being calibrated, for example:

P1 = **5E-1**

P2 = pressure units, e.g. psi

P3 = full scale range of the strain gauge, e.g. 10000 psi

P4 = the minimum scale range of the strain gauge, e.g. 0 psi

P5 = the required decimal point position

P6 = As selected - usually high

P7 = On. Shunt calibration enabled, if the pressure transducer is fitted with an internal shunt resistor.

P8 = the correct percentage (80% for a typical transducer).

##### In Level 2

1. Open the calibration switch (if fitted)
2. Select **LoE** (low calibration for the primary input). Ensure that no pressure is applied to the transducer.
3. Use **▼** or **▲** to switch upper display from **OFF** to **On**.
4. Then press **↵** to start the low calibration.
5. The instrument calibrates to zero pressure.
6. Close the calibration switch
7. Select **HiE** (span calibration for the primary input. Note this is normally 80% of span but can be changed by P8 to suit a specific transducer.)
8. Use **▼** or **▲** to switch upper display from **OFF** to **On**.
9. Then press **↵** to start the calibration.
10. The instrument calibrates to 80% of its span

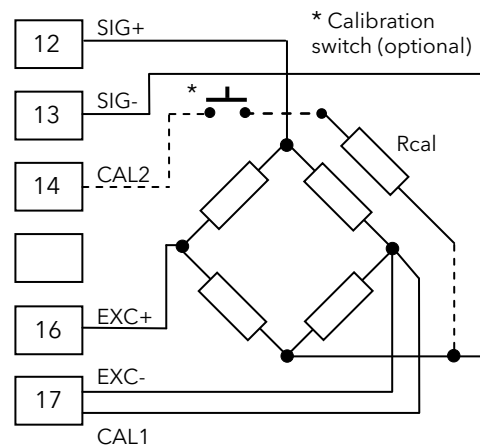

#### 3.11.2 Calibration of pressure transducers with an external shunt resistor

Connect the external shunt resistor (value as specified by the transducer manufacturer) across terminals 13/14. Ensure that the full scale and low scale values have been set to match the range of the transducer, the Shunt function is On and P8 is set to the correct percentage as listed above.

In Level 2, repeat steps 1 to 8 above.

Note: The transducer may also be connected to the secondary input using terminals 6 to 11.

#### 3.11.3 Calibration of an amplified pressure transducers with an internal shunt resistor

In configuration level ensure that P7 is set to OFF, then repeat steps 1 to 8 above.

#### 3.11.4 Calibration of pressure transducer connected to the secondary input

This is the same as above but in Level 2 use the **Lo2E** (zero calibration) and **Hi2E** (Span calibration) parameters instead of **LoE** and **HiE**.

## 4. Controller Block Diagram

The block diagram shows the function blocks which make up the controller. Where applicable, each block is represented by the 'P' code as described in the section 5.

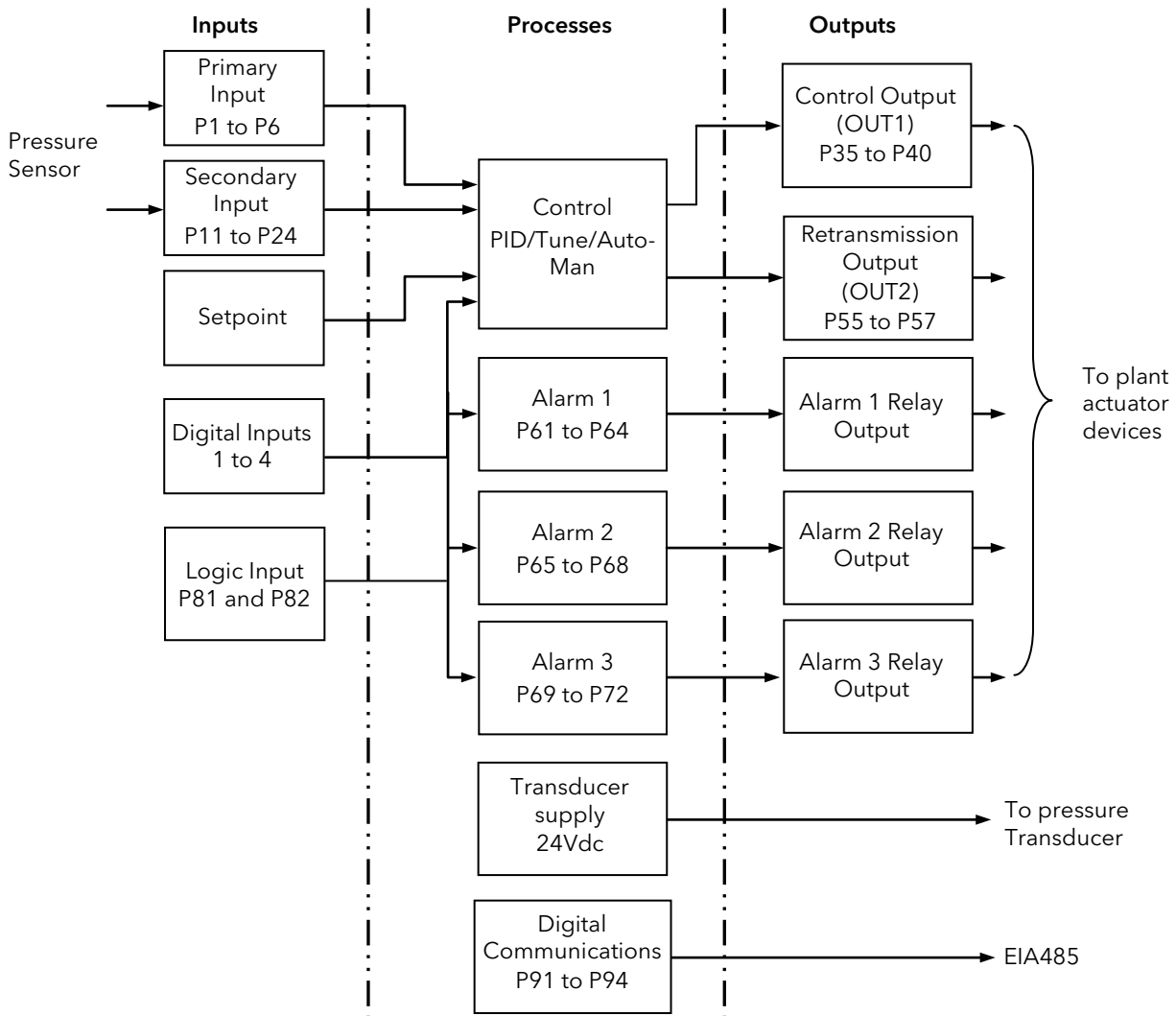

The pressure is measured by the pressure transducer which can be connected to either the Primary or Secondary Inputs. The measurement is compared with a Setpoint (SP) set by the user. The measured analogue value can be retransmitted using output 2 (OUT2).

The purpose of the control block is to reduce the difference between SP and PV (the error signal) to zero by providing a compensating output to the plant via the output block 1 (OUT1).

The three alarms blocks monitor the measured pressure and can be configured to respond to high, low, band or deviation alarms and operate relay outputs.

EIA485 digital communications provides an interface for data collection, monitoring and remote control.

The way in which each block performs is defined by its internal parameters. Some of these parameters are available to the user so that they can be adjusted to suit the characteristics of the process which is to be controlled.

These parameters are found in lists in Operator Level 1, Operator Level 2 and Configuration level ('P' codes shown in the following section).

## 5. Configuration Level

Configuration of the controller is carried out using a list of 'P' codes. Each P code is associated with a particular feature of the controller such as Input Type, Ranging, Control Type, Outputs, Alarms, Digital Communications, Calibration, etc. These are listed in the tables in section 5.2.







### WARNING

Configuration level gives access to a wide range of parameters which match the controller to the process. Incorrect configuration could result in damage to the process being controlled and/or personal injury. It is the responsibility of the person commissioning the process to ensure that the configuration is correct.

In configuration level the controller is not controlling the process or providing alarm indication.





Do not select configuration level on a live process.

### 5.1 To Select Configuration Level

1. Press and hold  until the lower display shows "GoTo" (approximately 4 seconds).
2. Press  or  to select **CONF**.
3. Confirm the selection with .
4. Enter the passcode (default: 4).

### 5.2 Configuration Level Parameters

Configuration parameters are defined by a set of 'P' codes.

1. Press  to scroll through the list of 'P' codes.
2. Press  or  to select the function associated with the 'P' code.
3. Press  to accept the function.



To scroll back press .

A summary and description of the 'P' codes is given in the following sections.

### 5.3 Configuration - 'P' Codes

Use these codes to configure the controller to meet the requirements of the process.

#### 5.3.1 Summary

This section gives an overview of the 'P' codes.

Sensor input and Ranging	<i>P1</i>	Pressure input selection	Alarms	<i>P61</i>	Alarm 1 input channel link
	<i>P2</i>	Pressure input engineering unit		<i>P62</i>	Alarm 1 type
	<i>P3</i>	Pressure input full scale value		<i>P63</i>	Alarm 1 reset mode
	<i>P4</i>	Pressure input low scale value		<i>P64</i>	Alarm 1 failsafe mode
	<i>P5</i>	Pressure input decimal point position		<i>P65</i>	Alarm 2 input channel link
	<i>P6</i>	Pressure input fail safe		<i>P66</i>	Alarm 2 type
Calibration	<i>P7</i>	Shunt calibration		<i>P67</i>	Alarm 2 reset mode
	<i>P8</i>	Shunt value		<i>P68</i>	Alarm 2 failsafe mode
	<i>P9</i>	Display update time for the pressure input		<i>P69</i>	Alarm 3 input channel link
Secondary Input	<i>P11</i>	Secondary input selection		<i>P70</i>	Alarm 3 type
	<i>P12</i>	Secondary input function		<i>P71</i>	Alarm 3 reset mode
	<i>P19</i>	Secondary input full scale value	<i>P72</i>	Alarm 3 failsafe mode	
	<i>P20</i>	Secondary input low scale value	Logic input	<i>P81</i>	Logic input configuration
	<i>P21</i>	Secondary input fail safe		<i>P82</i>	Logic input status
	<i>P22</i>	Remote set point input range low	Peak detection	<i>P83</i>	Peak detection
	<i>P23</i>	Remote set point input range high	Line frequency	<i>P84</i>	Line frequency
	<i>P24</i>	Secondary input sample time		<i>P85</i>	Line frequency readout
Control output	<i>P35</i>	Control output selection	Auto/Manual	<i>P86</i>	Manual/auto start-up
	<i>P36</i>	Control output range low		<i>P87</i>	Manual/auto transfer
	<i>P37</i>	Control output range high	Digital communications	<i>P91</i>	Serial communication interface address
	<i>P38</i>	Control output decimal point position		<i>P92</i>	Protocol type
	<i>P39</i>	Control output manual mode indication		<i>P93</i>	Communication type
	<i>P40</i>	Direct/reverse selection for control output		<i>P94</i>	Communication baud rate
Retransmission	<i>P55</i>	Output selection	Pass codes	<i>P98</i>	Level 2
	<i>P56</i>	Output range low		<i>P99</i>	Configuration level
	<i>P57</i>	Output range high	Configuration recovery	<i>rEcL</i>	Recovery point



### 5.3.2 Pressure Input Selection

Code	Description	Range	
P1	Configures the <b>Type of Pressure Input</b> . Note: Remember to properly wire the unit's terminal block	Str	Strain gauge (default)
		0-20	0-20 mA
		4-20	4-20 mA
		0-5	0-5V
		0-10	0-10V.
P2	Configures the <b>Pressure Input Engineering Unit</b> Changing the Engineering Unit causes the scaling of parameter values linked to the pressure input. (for example: if P2 = 10000 PSI , changing from PSI to BAR automatically scales P2 to 689 BAR)	OFF	Off all beacons are turned off
		h0cn2	kg/cm <sup>2</sup> beacon lit
		PSI	psi beacon lit
		bAR	bar beacon lit (default)
		nPA	MPa beacon lit
P3	Configures the <b>Full Scale Value for the Pressure Input</b> Changing to this value causes the loading of the default values for the pressure input low scale, the alarm set points, the remote set point limits, the set point limits, the set point and the retransmission limits and the secondary input low/high range is reset to the primary input value.	from 10 to 99950	Default 10000
P4	Configures the <b>Low Scale Value for the Pressure Input</b>	from +/- 25% of Full scale value.	Default 0
P5	Configures the <b>Pressure Input Decimal Point Position</b> Use  or  keys to select the position of the decimal point.	nnnnn nnnn.n nnn.nn nn.nnn n.nnnn	Default nnnnn
P6	Configures the <b>Pressure Input Fail Safe Condition</b>	Hi	High (default)
		Lo	Low

### 5.3.3 Shunt Calibration

Code	Description	Range	
P7	Configures the <b>Shunt Calibration</b> . This parameter is set to On to enable field calibration of the pressure transducer. See also section 3.11.	OFF	Off
		On	On (default)
P8	Configures the <b>Shunt Value</b> This is the value at which the pressure transducer is calibrated and is normally stated by the manufacturer of the unit.	From 40.0 to 100.0%	Default 80.0%

### 5.3.4 Pressure Input Display Update Time



Code	Description	Range	
P9	Configures the <b>Display update time for the pressure transducer</b> . A fast update time can be useful to get the display refreshed at every analogue to digital converter sample. However, there are instances when this can be a distraction. For this reason display update time may be selected to suit individual preferences.	0.050	50 mS
		0.100	100mS
		0.250	250mS
		0.400	400mS

### 5.3.5 Secondary Input

Code	Description	Range	
<b>P11</b>	Configures the <b>Secondary Input Type</b> Remember to properly wire the unit's terminal block.	<b>OFF</b>	Disabled
		<b>0-20</b>	0-20mA
		<b>4-20</b>	4-20mA (default)
		<b>0-5</b>	0-5 Volts
		<b>0-10</b>	0-10 Volts
		<b>Str</b>	Strain Gauge
<b>P12</b>	Configures the <b>Function of the Secondary Input</b> It is available only if P11 is different from OFF. It is alterable if P11 is different from <b>Str</b> ; otherwise it is forced to <b>rSP</b> .	<b>rSP</b>	The input acts as a remote set point (default)
		<b>d1FFP</b>	The input acts as the second sensor for differential pressure measurement
<b>P19</b>	Configures the <b>Secondary input full scale value</b> This must be set to match the range of the pressure transducer in use. It is available only if P11 is different from OFF and P12 is equal to <b>d1FFP</b> .	From 0 to the full scale value	Default 10000 (psi)
<b>P20</b>	Configures the <b>Secondary input low scale value.</b> It is available only if P11 is different from <b>OFF</b> and P12 is equal to <b>d1FFP</b> .	From +/- 25% of the 'Secondary input full scale value' set by P19	Default 0
<b>P21</b>	Configures the <b>Remote set point input fail safe condition</b> It is available only if P11 is different from <b>OFF</b> and P12 is equal to <b>rSP</b> .	<b>HI</b>	High
		<b>LO</b>	Low (default)
<b>P22</b>	Configures the <b>Remote set point input range low</b>	From 0 to P3	Default 0
<b>P23</b>	Configures the <b>Remote set point input range high.</b>	From 0 to P3	Default P3
<b>P24</b>	Configures the <b>Sample time for the secondary input</b>  This may be selected to suit the rate of change of the remote set point input. Using short sample time the process can track the RSP input faster. However, this can result in an increase in noise. For this reason the sample time is made selectable to suit the particular process.	<b>0.100</b>	100ms
		<b>0.200</b>	200ms
		<b>0.500</b>	500ms (default)
		<b>1.000</b>	1000ms

### 5.3.6 Control Output

The control output is an analogue output and is always OUT1 on terminals 21 and 22

Code	Description	Range	
P35	Configures the <b>Type of control output</b> . Remember to wire the terminal block correctly.	0-20	0-20mA
		4-20	4-20mA
		0-10	0-10 Volts (default)
		-10.10	-10 to +10 Volts
		0-5	0-5 Volts
P36	Configures the <b>Control output range low</b> This is for scaling the RPM output	-10000 to P37	Default 0. The upper value is limited by the setting of P37.
P37	Configures the <b>Control output range high</b> This is for scaling the RPM output	P36 to 10000	Default 100.0. The lower value is limited by the setting of P36.
P38	Configures the <b>Control output decimal point position</b> . Use the  or  keys to select the position of the decimal point.	nnnnn	
		nnnn.n	Default
		nnn.nn	
		nn.nnn	
		n.nnnn	
P39	Configures the <b>Control output manual mode indication</b> . Use this parameter to select how the output value is shown in the operator display when the controller is in manual mode; in the range 0-100.0% or scaled with control output high and control output low parameters (RPM indication).	100.0 or rPn	100.0 will show OUT% and rPn will show RPM in the green display next to the setpoint value. Default 100.0
P40	Configures the <b>Direct or Reverse action for the control output</b> . Direct acting means that the value of the control output increases as the value of the input (measured value) increases (PV < SP). Reverse acting means that the control output decreases as the measured value increases (PV > SP). This parameter also configures the visualisation between the control output and how it is shown in the controller display. The first digit shows the relationship between input signal and displayed output value. The last digit shows the relationship between displayed output signal and the actual output value. This is shown in the example below		
		r d (default)	
		r r	
		d d	
		d r	

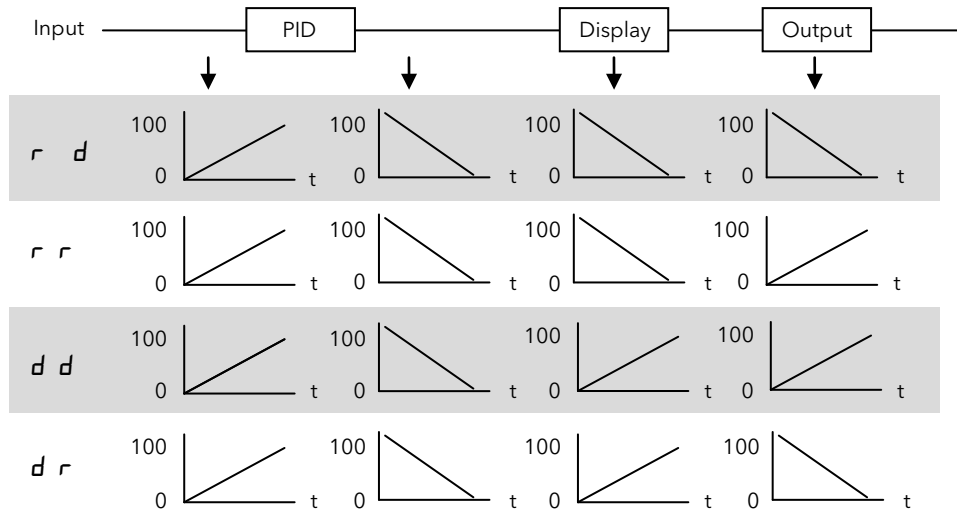

### 5.3.7 Retransmission

The measured pressure can be retransmitted as an analogue value on OUT2, terminals 56 and 57.

Code	Description	Range	
<b>P55</b>	Configures the <b>Type of Retransmission</b> Available only if the retransmission circuit is fitted.	<b>OFF</b>	Disabled
		<b>0-20</b>	0-20mA
		<b>4-20</b>	4-20mA
		<b>0-10</b>	0-10 Volts
		<b>-10.10</b>	-10 to +10 Volts
		<b>0-5</b>	0-5 Volts
<b>P56</b>	Configures the <b>Low range for the retransmitted output</b> Available only if P55 is different from OFF.	From <b>0</b> to <b>P3</b> Pressure input full scale value	Default 0
<b>P57</b>	Configures the <b>High range for the retransmitted output</b> Available only if P55 is different from OFF.	From <b>0</b> to <b>P3</b> Pressure input full scale value	Default P3

### 5.3.8 Alarms

Up to three alarms can be configured. They are used to detect out of range values.

Code	Description	Range	
<b>P61</b>	Configures the <b>Alarm 1 selection</b> .  All alarms can be attached to the measured pressure, a deviation from setpoint, a band about the pressure measurement or turned off.	<b>OFF</b>	Disabled
		<b>Proc</b>	Process alarm (default)
		<b>bAnd</b>	Band alarm
		<b>dEv</b>	Deviation alarm
<b>P62</b>	Configures the <b>Alarm 1 type</b> .  Available only if P61 is different from OFF.  If P61 is configured as a band alarm, high means outside the band while low means inside the band.	<b>HI</b>	High - an alarm will be triggered if the measured value exceeds a high setting
		<b>LO</b>	Low - an alarm will be triggered if the measured value exceeds a low setting
		<b>l nhl b</b>	Low with mask at start up (sometimes referred to as 'blocking'). A low alarm will be inhibited until the process has gone above the alarm value for the first time. (default)
<b>P63</b>	Configures the <b>Alarm 1 reset mode</b> .  Available only if P61 is different from OFF.  The alarm reset mode determines if the alarm resets once the alarm condition is no longer true or whether the alarm needs to be reset manually.	<b>AUTO</b>	Automatic (default). The alarm is no longer indicated once it is no longer true.
		<b>LATCH</b>	Latching. The alarm remains indicated even if it is no longer true. It can be manually reset by pressing the 'Reset' button on the front panel or by making a contact between terminals 23 and 24 (if P81 is configured as AL or AL-P).
<b>P64</b>	Configures the <b>Alarm 1 failsafe mode</b> .  Available only if P61 is different from OFF.  This parameter determines the action the alarm will take in the event of a power fail to the instrument. In failsafe mode when the controller is powered on the normally closed contact is held <b>open</b> while the normally open contacts are held <b>closed</b> . On power failure they are released as the relay relaxes.  This feature should be used as a shut down alarm.	<b>FS</b>	Failsafe (default). In the event of a power fail the alarm will activate.
		<b>nFS</b>	Non failsafe
<b>P65</b>	Configures the <b>Alarm 2 selection</b> .  To disable alarm 2 or set it as Process, Band or Deviation alarm the same as P61	Same as P61	
<b>P66</b>	Configures the <b>Alarm 2 type</b>  Available only if P65 is different from OFF.	Same as P62. Default <b>HI</b> .	
<b>P67</b>	Configures the <b>Alarm 2 reset mode</b> .  Available only if P65 is different from OFF.	Same as P63	
<b>P68</b>	Configures the <b>Alarm 2 failsafe mode</b>  Available only if P65 is different from OFF.	Same as P64	
<b>P69</b>	Configures the <b>Alarm 3 selection</b> .  To disable alarm 2 or set it as Process, Band or Deviation alarm the same as P61	Same as P61	
<b>P70</b>	Configures the <b>Alarm 3 type</b>  Available only if P69 is different from OFF.	Same as P62. Default <b>HI</b> .	
<b>P71</b>	Configures the <b>Alarm 3 reset mode</b> .  Available only if P69 is different from OFF.	Same as P63	
<b>P72</b>	Configures the <b>Alarm 3 failsafe mode</b>  Available only if P69 is different from OFF.	Same as P64	

### 5.3.9 Logic Input

The Logic Input is fitted as standard and can be configured as a reset for alarms or peak detection, or it can be used to externally select the pressure transducer calibration. It is a contact closure input but is edge triggered on contact closure.

Code	Description	Range	
<b>PB1</b>	Configures the <b>Logic Input</b>  This is the logic input connected to terminals 23 and 24.  Do not confuse this with the digital inputs DIG1 to DIG4 which have fixed functionality.	<b>OFF</b>	Disabled
		<b>AL</b>	Alarm reset
		<b>P</b>	Peak reset
		<b>AL-P</b>	Alarm + peak reset (default)
		<b>CAL0</b>	Zero calibration
		<b>ALL</b>	Zero calibration + alarm reset + peak reset
<b>PB2</b>	Configures the <b>Status of the logic input</b>  Available only if P81 is different from OFF	<b>CLOSE</b>	The logic input is considered active when the contact is closed. (default)
		<b>OPEN</b>	The logic input is considered inactive when the contact is open.

Note: The controller has four additional digital inputs. These are a fixed configuration where:-

DIG1 = Manual

DIG2 = Increase output value

DIG3 = Decrease output value

DIG4 = Set the control output to 0. The front panel Auto/Man keys are disabled

They do not require P codes to configure.

### 5.3.10 Peak Detection

Code	Description	Range	
<b>PB3</b>	Configures the <b>Polarity of the peak detection</b>  P83 determines whether the maximum or minimum value of the measured signal is recorded by the controller.  The value is stored until it is reset by the front panel Reset key or by an external connection across terminals 23 and 24, (assuming P81 is configured as AL or AL-P).	<b>OFF</b>	Disabled
		<b>HI</b>	Maximum peak (default)
		<b>LO</b>	Minimum peak

### 5.3.11 Line Frequency

Code	Description	Range	
<b>PB4</b>	Configures the <b>Line frequency rejection</b>  The frequency of the ac supply can be detected automatically or selected manually.  It does not apply to certain conditions such as 24V DC power supply.	<b>50</b>	50 Hz
		<b>60</b>	60 Hz
		<b>Auto</b>	Line frequency is detected automatically (default).
<b>PB5</b>	Configures the <b>Line frequency readout</b> .  This is a read only value of the detected line frequency.  Available only when P84 is set to Auto	<b>50</b>	50 Hz.
		<b>60</b>	60 Hz
		<b>Und50</b>	automatic detection of the line frequency does not work (e.g. 24V DC power supply); a 50 Hz rejection is assumed.

## 5.3.12 Manual/Auto Start-Up

Code	Description	Range	
<b>PB6</b>	<p>Configures the <b>Controller status at power on</b>.</p> <p>The controller can be made to start up in Manual mode (power output demanded manually) or Automatic - power output controlled in closed loop.</p> <p>It is normal to start an extruder, for example, in Manual, but with output limited to reduce the risk of over-ranging the pressure, then switch over to Automatic control once steady conditions have been achieved.</p>	<b>AUTO</b>	Automatic closed loop control
		<b>MAN</b>	Manual control (default)
<b>PB7</b>	<p>Configures the <b>Manual/Auto transfer</b>.</p> <p>When control is transferred from Automatic (closed loop) to Manual the output remains at the value when in auto. It can be raised or lowered from this value manually.</p> <p>On transfer from Manual to Auto the controller takes the value in manual and gradually changes it according to the calculated demand from the control algorithm.</p>	<b>BUMPL</b>	Bumpless mode (without modification of set point). This is the default mode.
		<b>SP</b>	Set point modification mode

### 5.3.13 Digital Communications

Digital communications is orderable. It uses Modbus or Jbus protocol and EIA485 2-wire interface .

Code	Description	Range	
<b>P91</b>	<p>Configures the <b>Serial communication interface address</b>.</p> <p>Available only if Modbus/Jbus serial communication interface is fitted.</p> <p>On a network of instruments the address is used to specify a particular instrument. Each instrument on a network should be set to a unique address from 1 to 255.</p>	<b>OFF</b>	Disabled (default)
		<b>1 to 255</b>	An address of 1 to 255 can be set for any particular instrument.
<b>P92</b>	<p>Configures the <b>Protocol type</b>.</p> <p>Available only P91 is different from OFF.</p>	<b>ModbS</b>	Modbus (default)
		<b>JbUS</b>	Jbus
<b>P93</b>	<p>Configures the <b>Parity type</b>.</p> <p>Available only P91 is different from OFF.</p> <p>Parity is a method of ensuring that the data transferred between devices has not been corrupted. Parity is the lowest form of integrity in the message, it ensures that a single byte contains either an even or an odd number of ones or zeros in the data. In industrial protocols, there are usually layers of checking to ensure that first the byte transmitted is good and then that the message transmitted is good. Modbus applies a CRC (Cyclic Redundancy Check) to the data to ensure that the packet of data is not corrupted. Thus, there is usually no benefit in using odd or even parity, and since this also increases the number of binary bits transmitted for any messages, it decreases throughput.</p>	<b>8nonE</b>	8 bit without parity (default)
		<b>8EuEn</b>	8 bit + even parity
		<b>8odd</b>	8 bit + odd parity
<b>P94</b>	<p>Configures the <b>Baud rate</b>.</p> <p>Available only P91 is different from OFF.</p> <p>The baud rate of a communications network specifies the speed at which data is transferred between the instrument and the master. As a rule, the baud rate should be set as high as possible to allow maximum throughput. This will depend to some extent on the installation and the amount of electrical noise the communications link is subject to, but the instruments are capable of reliably operating at 19,200 baud under normal circumstances and assuming correct line termination.</p> <p>Although the baud rate is an important factor, when calculating the speed of communications in a system it is often the 'latency' between a message being sent and a reply being started that dominates the speed of the network. This is the amount of time the instrument requires on receiving a request before being able to reply.</p> <p>For example, if a message consists of 10 characters (transmitted in 10msec at 9600 Baud) and the reply consists of 10 characters, then the transmission time would be 20 msec. However, if the latency is 20msec, then the transmission time has become 40msec. Latency is typically higher for commands that write to a parameter than those that read, and will vary to some degree depending on what operation is being performed by the instrument at the time the request is received and the number of variables included in a block read or write. As a rule, latency for single value operations will be between 5 and 20 msec, meaning a turnaround time of about 25-40msec. This compares very favourably with competing devices, which can often take as much as 200msec to turn around communications transactions.</p> <p>If throughput is a problem, consider replacing single parameter transactions with Modbus block transactions, and increase the baud rate to the maximum reliable value in the installation</p>	<b>600</b>	600 bps
		<b>1200</b>	1200 bps
		<b>2400</b>	2400 bps
		<b>4800</b>	4800 bps
		<b>9600</b>	9600 bps
		<b>19200</b>	19200 bps (default)



### 5.3.14 Pass codes

Pass codes are required to enter both Operator Level 2 and Configuration Level. They are set to default values during manufacture but they can be re-configured using P98 and P99.

Code	Description	Range	
P98	<p>Configures the <b>Level 2 pass code</b>.</p> <p>The pass code required to enter Level 2 can be set in the range 0 to 9999.</p> <p>In the case of level 2 pass code being set to 0, it will not be necessary to enter a pass code to access level 2 and the controller will enter level 2 directly.</p>	0	No pass code is necessary to enter level 2.
		1 to 9999	Default 2
P99	<p>Configures the <b>Configuration level pass code</b>.</p> <p>The pass code required to enter Configuration Level can be set in the range 0 to 9999.</p> <p>In the case of the configuration level pass code being set to 0, it will not be necessary to enter a pass code to access configuration level and the controller will enter CONF directly.</p>	0	No pass code is necessary to enter configuration level.
		1 to 9999	Default 4

### 5.3.15 Recovery Point

Recovery Point is a way to initialize all parameter values to factory default values stored in read only memory. This can act as a very useful 'Undo' feature.

rEcL	Scroll to rEcL to select <b>Recovery point</b> .		<p><b>To Restore the Factory Default Settings</b></p> <p>Select rEcL</p> <p>Press  to select and to move on to the next parameter (in this case to the beginning of the CONF list).</p>
	nonE	Do nothing (default). The current settings will be used.	
	FRcL	Load and restore the factory default settings. The configuration and parameter values loaded during manufacture may be restored.	

## 6. Control

This section shows an example of how the control loop operates and how it may be used to control the melt pressure in an extrusion process.

The actual melt pressure (PV) is measured by the transducer which is connected to the input of the controller. This is compared with a setpoint (or required) pressure (SP) set by the user. If there is an error between the set and measured pressure the controller calculates an output value which is used to trim the speed of the extruder drive. The calculation depends on the process being controlled and is based on a PID (Proportional, Integral, Derivative) algorithm. In extruder pressure control the Derivative term is turned off (set to 0 by default).

This arrangement is referred to as the control loop or closed loop control.

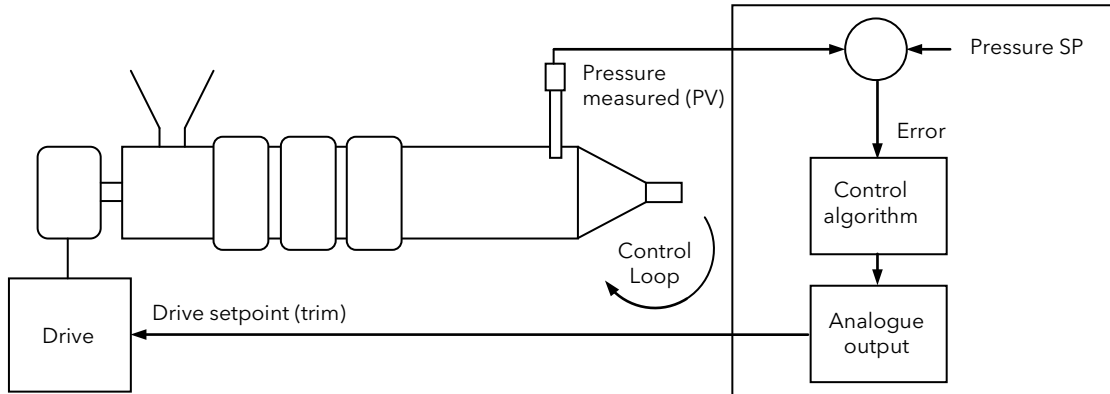

The following sections describe the PID parameters in general terms.

### 6.1.1 Control Algorithm

The PID algorithm may also be referred to as 'Three Term Control'.

The three terms are:

Proportional band  $P_b$

Integral time  $t_i$

Derivative time  $t_d$

The output from the controller is the sum of the contributions from these three terms. The combined output is a function of the magnitude and duration of the error signal, and the rate of change of the process value.

In Operator Level 2 it is possible to manually adjust these parameters and in some applications they may be set automatically using the Auto Tune feature (section 6.2).

### 6.1.2 Proportional Band ' $P_b$ '

This section describes the effect of the proportional term only, that is with the integral and derivative terms turned off. The proportional band, or gain, delivers an output which is proportional to the size of the error signal. It is the range over which the output power is continuously adjustable in a linear fashion from 0 to 100.00%. Below the proportional band the output is full on (100%), above the proportional band the output is full off (0) as shown in the diagram below.

The width of the proportional band determines the magnitude of the response to the error. If it too narrow (high gain) the system oscillates by being over responsive. If it is too wide (low gain) the control is sluggish. The ideal situation is when the proportional band is as narrow as possible without causing oscillation.

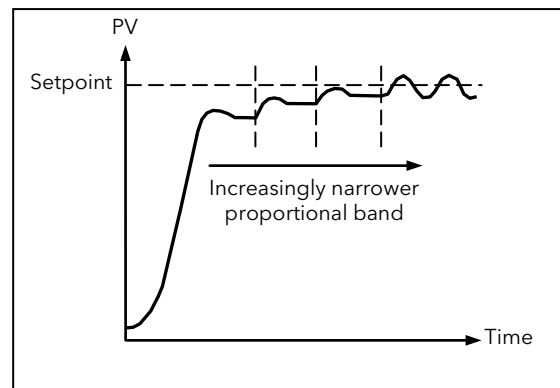
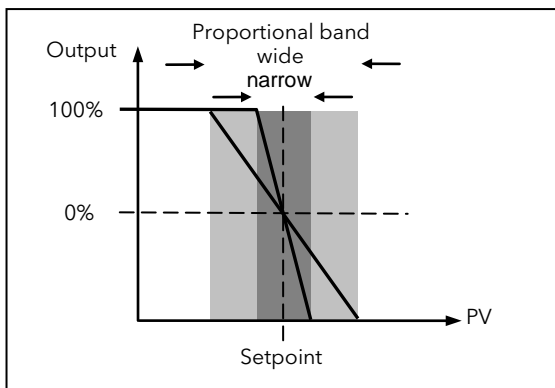

The diagram also shows the effect of narrowing proportional band to the point of oscillation. A very wide proportional band results in straight line control but with an appreciable initial error between setpoint and PV. As the band is narrowed the PV gets closer to setpoint. If the proportional band is very narrow the loop becomes unstable resulting in an oscillatory response.

The proportional band is set as a percentage of the controller range.

In practice although proportional only control will result in steady state control there will, most likely, be an offset between the SP and PV. This can be compensated for by adding an integral term as described in section 6.1.3 below.

### 6.1.3 Integral Term 'I'

In a proportional only controller, an error between setpoint and PV must exist for the controller to deliver an output. Integral is used to achieve **zero** steady state control error.

The integral term slowly shifts the output level as a result of an error between setpoint and measured value. If the measured value is below setpoint the integral action gradually increases the output in an attempt to correct the error. If it is above setpoint integral action gradually decreases the output to correct the error.

The diagram below shows the result of introducing integral action.

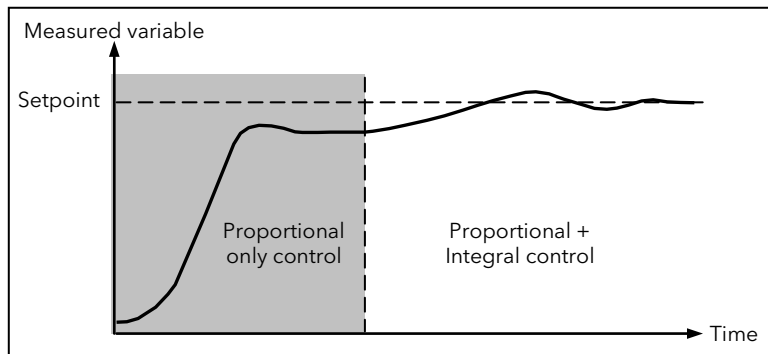

The units for the integral term are measured in time (0.1 to 99.9 seconds). The longer the integral time constant, the more slowly the output is shifted and results in a sluggish response. Too small an integral time will cause the process to overshoot and even oscillate.

### 6.1.4 Derivative Term 'D'

Derivative action, or rate, provides a sudden shift in output as a result of a rapid change in error. If the measured value falls quickly derivative provides a large change in output in an attempt to correct the perturbation before it goes too far. It is most beneficial in recovering from small perturbations.

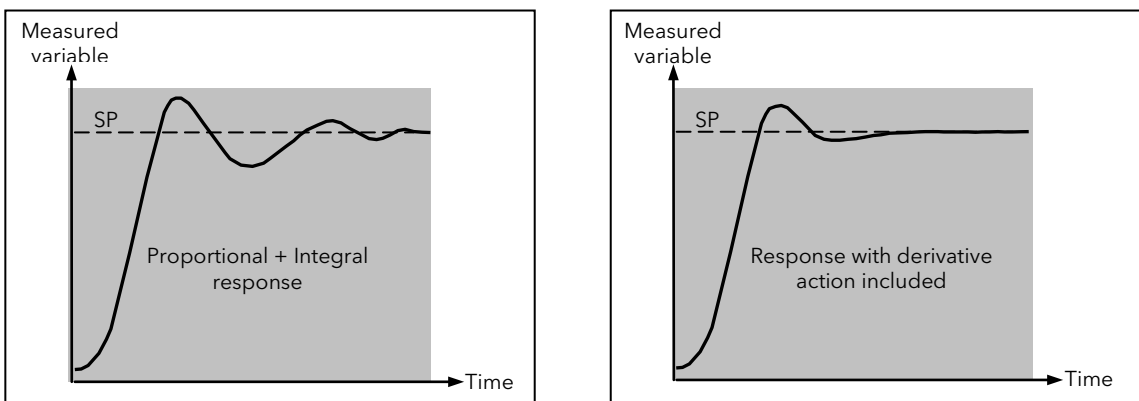

The derivative modifies the output to reduce the rate of change of error. It reacts to changes in the PV by changing the output to remove the transient. Increasing the derivative time will reduce the settling time of the loop after a transient change.

Derivative is often mistakenly associated with overshoot inhibition rather than transient response. In fact, derivative should not be used to curb overshoot on start up since this will inevitably degrade the steady state performance of the system.

Derivative is generally used to increase the stability of the loop, however, there are situations where derivative may be the cause of instability. For example, if the PV is noisy, then derivative can amplify that noise and cause excessive output changes. This is the situation typically associated with the control of melt pressure in an extruder and it is recommended to turn the derivative term off in this application. Off is the default value in P304c.

## 6.2 Tuning

In tuning, the PID parameters of the controller are matched to the process being controlled in order to obtain stable control.

There are two types of procedures which can be selected:

### 6.2.1 TUNE Function

The basic concepts of autotuning a system are based on the open loop step response. For this reason the TUNE function may only be activated in manual mode.

The equivalent mathematical model of the process is characterised by three parameters: the gain, the time constant and the equivalent time delay.

The power output of the controller is changed by a small step value and the controller stores the process variable response. When the transient response is finished, the controller estimates the three basic process parameters by means of the areas method and then it calculates the PI or PID parameters.

The step response is a convenient way to characterise this type of process dynamics because of its modest alteration of the behaviour of the process and its capabilities to estimate the process parameters with high precision.

- To implement the TUNE algorithm set the instrument to **Manual** mode - the '**Man**' Indication will be lit. Then, in level 2, select **TUNE** to **On**. During this procedure the '**Tune**' status indication will be flashing.
- The TUNE function will switch off after the PID parameters have been calculated, and the 'Tune' status indication extinguished.

### 6.2.2 ADAPTIVE Function

The ADAPTIVE function is an on-line algorithm that "observes" the measured value and looks for oscillation due to a variation of the load or the set-point. When a significant pattern is "recognised" a decisional procedure starts in order to recalculate the PID parameters.

The ADAPTIVE function is recommended for pressure control applications where the cycling of the output using the TUNE function described above is to be avoided.

- To implement the ADAPTIVE algorithm set the instrument to **Automatic** mode. Then, in level 2, select **TUNE** to **On**. During this procedure the '**Tune**' status indication will be steady. In this case the **On** setting will be remembered by the instrument even if the instrument is switched off.
- In order to deactivate the adaptive function, it is necessary to return the **TUNE** parameter to **OFF**.
- When the ADAPTIVE procedure is enabled the PID parameters (**Pb**, **ti**, **td** - Level 2) can only be monitored as they are calculated. Manual adjustment is inhibited.

### 6.2.3 Automatic stand-by:

This function avoids overshoot due to temporary process interruptions (PV goes to zero).

In these cases the controller output rapidly reaches saturation of the integral factor. When the process restarts the controlled output will have an excessive and potentially dangerous high output level. In an extruder the drive would then start at full speed.

When the "automatic stand-by" function is activated (Level 2, **ASb** = **On**) the algorithm monitors the controller input and output. When the input value goes lower than a threshold (specified by the "automatic stand-by pressure low limit" parameter **ASbPL**) and the output value reaches the saturation condition, the control output immediately assumes the last value stored when the process was stable.

This freezing of the output of the controller will last for a time specified by the "automatic stand-by recovery time" parameter (Level 2, **ASbrt**).

If the controller input does not recover within the specified time, the output value is forced to zero.

If the controller input recovers within the specified time, the algorithm waits for two and half times the integral value. After this time has elapsed, the controller will return automatically to normal "running" conditions, that is, to the output level calculated when the process was stable.

## 6.3 Start up of a Process

The P304c allows a process to be started in Manual or Automatic mode. The default is Manual since most of the applications for which this instrument is designed is for extruder melt pressure control which modifies the motor speed to control the pressure. It is generally not recommended to start motor control applications in automatic.

However, there are non motor speed applications for which the P304c may be used where automatic start up is recommended.

## 7. Digital Communications

Digital Communications (or 'comms' for short) allows the controller to communicate with a PC or a networked computer system. The pc may be running a SCADA package or iTools software which is a free downloadable package available from [www.eurotherm.co.uk](http://www.eurotherm.co.uk) and is used (in some instruments for configuration purposes) or for setting and cloning parameters.

This product conforms to Modbus/Jbus RTU protocol a full description of which can be found on [www.modbus.org](http://www.modbus.org).

One optional EIA485 port on terminals 60, 61 and 62 may be ordered with the following specification:-

Electrical interface	Optional, EIA485 type, opto-isolated.	
Protocol type	Modbus/Jbus (RTU mode).	Configured by 'P' code P92
Type of parameters	Run-time and configuration. Both are available by serial link.	
Configuration software	Through a dedicated PC software application package.	
Device address	From 1 to 255. Note: The device physical interface can only support up to 31 devices for each segment. Use multiple segments for more of 31 devices.	Configured by 'P' code P91
Baud rate	600 up to 19200 baud.	Configured by 'P' code P94
Format	1 start bit, 8 bit with/without parity, 1 stop bit	Configured by 'P' code P93
Parity	Even/Odd.	

Each parameter has its own unique Modbus address. A list of the most commonly used parameters is given in Appendix 10.

### 7.1 EIA485 Field Communications Port

To use EIA485, buffer the EIA232 port of the PC with a suitable EIA232/EIA485 converter. The Eurotherm KD485 Communications Adapter unit is recommended for this purpose. The use of a EIA485 board built into the computer is not recommended since this board may not be isolated, which may cause noise problems, and the RX terminals may not be biased correctly for this application.

To construct a cable for EIA485 operation use a screened cable with one (EIA485) twisted pair plus a separate core for common. Although common or screen connections are not necessary, their use will significantly improve noise immunity and their use is recommended in a factory environment.

### 7.2 Modbus/JBus Protocol

A description of the use of Modbus or JBus protocol is given in the Communication Handbook part number HA026230 which may be downloaded from [www.eurotherm.co.uk](http://www.eurotherm.co.uk).

This should be used in conjunction with the list of parameter addresses given in Appendix 10.

The user should also be aware of the following:-



#### Warning

**In common with most instruments in its class, the P304 Range uses a non-volatile memory with a limited number of specified writes. Non-volatile memory is used to hold information that must be retained over a power cycle, and typically, this includes setpoint and status information.**

**Please ensure that parameters which do not require updating on a regular basis (for example, setpoints, alarm trip levels, hysteresis, etc) are only written to when a change in the parameter value occurs. Failure to do this could result in permanent damage to the internal EEPROM.**

## 8. Instrument Calibration





The controller is calibrated during manufacture using traceable standards for every input and output range. It is, therefore, not necessary to calibrate it when changing ranges. Furthermore, the use of a continuous automatic zero correction of the input ensures that the calibration of the instrument is optimised during normal operation.

Also, retro-fitting an optional board does not require the calibration of the added circuit, because the board will be shipped from factory already calibrated.



However, there are certain statutory procedures which require verification and possible re-calibration of the instrument. This section describes the procedure and should not be confused with user calibration of the pressure transducer described in section 3.11.

### 8.1 To Access Calibration Mode

Select Configuration level as stated in section 5.1.

1. Then, when **CONF** is being displayed, press and hold the  button again for about 4 seconds until the **Go to** message is shown.
2. Press the  or  button to select **ICAL**
3. Press  to confirm and enter the level.





4. The display will show
5. Press  to scroll through a list of inputs and outputs which may be calibrated (or press  to return to the previous parameter). The list of all possible calibration parameters (not all of which will be applicable to your particular controller) is given below:-

Parameter	Circuit	Input/output Type	Range	Value	Note
PL020	Pressure input	Current	Zero	0mA	
PH020	Pressure input	Current	Full scale	20mA	
P 020	Pressure input	Current	Verify		(1)
PL0 5	Pressure input	Voltage 0/5V	Zero	0V	
PH0 5	Pressure input	Voltage 0/5V	Full scale	5V	
P 0 5	Pressure input	Voltage 0/5V	Verify		(1)
PL0 10	Pressure input	Voltage 0/10V	Zero	0V	
PH0 10	Pressure input	Voltage 0/10V	Full scale	10V	
P 0 10	Pressure input	Voltage 0/10V	Verify		(1)
SL020	Secondary input	Current	Zero	0mA	
SH020	Secondary input	Current	Full scale	20mA	
S 020	Secondary input	Current	Verify		(1)
SL0 5	Secondary input	Voltage	Zero	0V	
SH0 5	Secondary input	Voltage	Full scale	5V	
S 0 5	Secondary input	Voltage	Verify		(1)
SL0 10	Secondary input	Voltage	Zero	0V	
SH0 10	Secondary input	Voltage	Full scale	10V	
S 0 10	Secondary input	Voltage	Verify		(1)
SLtc	Secondary input	Thermocouple	Zero	0mV	
SHtc	Secondary input	Thermocouple	Full scale	50mV	
S t c	Secondary input	Thermocouple	Verify		(1)
S . r J	Secondary input	Thermocouple	Ref. junction	Ambient temperature	
S . r J	Secondary input	Thermocouple	Verify	Ambient temperature	
SLrtd	Secondary input	RTD-Pt100	Zero	0 Ohm	
SHrtd	Secondary input	RTD-Pt100	Full scale	320 Ohm	
S r t d	Secondary input	RTD-Pt100	Verify		(1)
SLPt5	Secondary input	RTD-Pt500	Zero	0 Ohm	
SHPt5	Secondary input	RTD-Pt500	Full scale	1600 Ohm	

Parameter	Circuit	Input/output Type	Range	Value	Note
<i>S Pt5</i>	Secondary input	RTD-Pt500	Verify		(1)
<i>PL Cur</i>	Main analogue output OUT1	Current	Zero	-5mA	
<i>PH Cur</i>	Main analogue output OUT1	Current	Full scale	25mA	
<i>P Cur</i>	Main analogue output OUT1	Current	Verify		(2)
<i>PL VOL</i>	Main analogue output OUT1	Voltage	Zero	-12.5V	
<i>PH VOL</i>	Main analogue output OUT1	Voltage	Full scale	+12.5V	
<i>P VOL</i>	Main analogue output OUT1	Voltage	Verify		(2)
<i>SL Cur</i>	Secondary analogue output OUT2	Current	Zero	-5mA	
<i>SH Cur</i>	Secondary analogue output OUT2	Current	Full scale	25mA	
<i>S Cur</i>	Secondary analogue output OUT2	Current	Verify		(2)
<i>SL VOL</i>	Secondary analogue output OUT2	Voltage	Zero	-12.5V	
<i>SH VOL</i>	Secondary analogue output OUT2	Voltage	Full scale	+12.5V	
<i>S VOL</i>	Secondary analogue output OUT2	Voltage	Verify		(2)
<i>dEFLt</i>	Load default calibration and code data. <b>Note:</b> If an incorrect calibration is performed an error code may be displayed. A list of error codes is given in section 8.2.		<i>OFF</i>	No action	
			<i>On [</i>	Load default calibration values. Then press  to confirm.	

The value stated in the 'Value' column is the value at which the instrument is calibrated. This is further shown in the examples at the end of this section.

#### Notes:

- (1) The display values for analogue inputs are scaled from 0 to 25000 counts.
- (2) Use the  or  keys to select a display value from 0 to 10 and to check the linearity of output circuit at 0%, 10%, .. 90% and 100% of full scale value +/- 0.05% of full scale value.

- (3) When the display is showing  it is possible to interrogate a number of functions as follows.

#### Press or to select:-

- Firmware revision
- Pressure input counts
  - Zero, for the strain gauge input (*P.SG.Lo*)
  - Span, for the strain gauge input (*P.SG.Hi*)
  - Pressure (*P.SG*)
  - Zero, for the linear inputs (*PLi.Lo*)
  - Span, for the linear inputs (*PLi.Hi*)
  - Current (*P.D20*)
  - Voltage, 0-10V (*P.D.10*)
- Secondary input counts
  - Zero, for the strain gauge input (*S.SG.Lo*)
  - Span, for the strain gauge input (*S.SG.Hi*)
  - Pressure (*S.SG*)
  - Zero, for the linear inputs (*SLi.Lo*)
  - Span, for the linear inputs (*SLi.Hi*)
  - Current (*S.D20*)
  - Voltage, 0-10V (*S.D.10*)
  - Thermocouple and RTD (*S.tC.Pt*)
  - Reference junction (*Sr.J*)
  - Line resistance for RTD (*Sr.L*)
- Line frequency (*FrE*)
- Digital inputs status (*di GJ n*)
- Minimum power consumption. The display will blank as the instrument is consuming minimum power
- Maximum power consumption. The display will show all segments as the instrument is consuming maximum power

## 8.2 Error Codes



The following error codes could be displayed:-

Code	Meaning
1	Error during EEPROM access.
2	The TUNE (auto tune) function is not able to apply the step change because the manual output value plus the step value is over/under the output limits
3	Wrong zero measure
4	TUNE (auto tune) function aborted due to an over/under-range of the measured input.
5	Input calibration error.
6	Wrong reference junction measure.
7	TUNE (auto tune) function aborted due to an high delay time over constant time ratio.
8	Error during the automatic calculation of the filter time constant
9	Too many attempts during process estimation.
10	TUNE (auto tune) function aborted due to a negative constant time or a negative process gain
11	Overload or short-circuit on strain gauge power supply. "+EXC" or "-EXC" unconnected wire for strain gauge input.
13	Wrong span measure
14	Internal I <sup>2</sup> C bus communication error with EEPROMs
15	Internal I <sup>2</sup> C bus communication error with i/o expanders.
RAM	Failure of RAM circuit. The device needs repair

In the case of differential pressure input, the error message in the "Normal display mode" points out the kind of failure: scroll through the Level 1 list and look at the "PI.VAL" or "SI.VAL" parameters to identify the faulty channel.

When the upper display shows "Err" and the lower display shows a parameter mnemonic code this means that the related parameter is in error status.

In this situation two options are available:

- 1) If the wrong parameter is a run-time or configuration parameter, pressing the  +  push-buttons the instrument will load the default values for all parameters.
- 2) If the wrong parameter is a calibration parameter pressing the SCROLL + PAGE push-buttons will enable the instrument to access run-time parameters; this function is intended only to restore a misplaced parameter's value, then the performances of the instrument are not guaranteed. The user is advised to check the stated calibration or code parameter.



### 8.3 Example 1: To Calibrate the 0-10V Main Input

Connect a calibrated voltage source the main input terminals as shown.

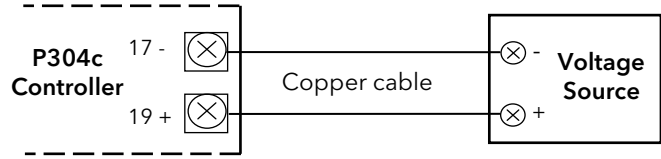

Action	Display	Notes
Press  to scroll to the low calibration point for the 0-10V main input, <i>PLD 10</i>		
Set the voltage input source to 0.000V		Wait a few seconds for the measurement to stabilise
Press  or  keys to select On Press  to enter the low calibration mode		The top display will show a decimal point for a few seconds as the input calibrates to minimum range value.
If successful the display will go to the high calibration point, <i>PHD 10</i>		If unsuccessful the display will show Err5 - Input calibration out of range. Check the setting of the voltage source.
Set the voltage input source to 10.000V		Wait a few seconds for the measurement to stabilise
Press  or  keys to select On Press  to enter the high calibration mode		The top display will show a decimal point for a few seconds as the input calibrates to maximum range value (10.000V).
If successful the display will go to verify, <i>P 0 10</i>		The upper display shows the number of counts relative to the measured value. the calibration is correct if the number of counts is within $25000 \pm 10$ counts
Check the linear input by resetting the calibrator to 0.00V		The resulting indication should be $0 \pm 10$ counts
Check the linearity by setting the calibrator to 5V		The resulting indication should be $12500 \pm 20$ counts
Press  to select the next calibration parameter		

The procedure for calibrating the 0-10V secondary voltage input is the same but uses the parameters:

*SLD 10*

*SHD 10*

*SHD 10*

## 8.4 Example 2: To Calibrate the 0-5V Main Input

Connect a calibrated voltage source the main input terminals as shown.

The procedure is the same as for the above example but uses different parameters and voltage values.

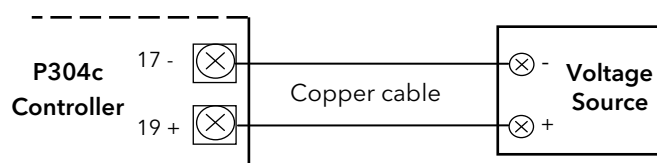

Action	Display	Notes
Press  to scroll to the low calibration point for the 0-10V main input, <i>PLD 5</i>		
Set the voltage input source to 0.000V		Wait a few seconds for the measurement to stabilise
Press  or  keys to select On Press  to enter the low calibration mode		The top display will show a decimal point for a few seconds as the input calibrates to minimum range value.
If successful the display will go to the high calibration point, <i>PHD 5</i>		If unsuccessful the display will show Err5 - Input calibration out of range. Check the setting of the voltage source.
Set the voltage input source to 5.000V		Wait a few seconds for the measurement to stabilise
Press  or  keys to select On Press  to enter the high calibration mode		The top display will blank for a few seconds as the input calibrates to maximum range value (5.000V).
If successful the display will go to verify, <i>P 0 5</i>		The upper display shows the number of counts relative to the measured value. the calibration is correct if the number of counts is within $25000 \pm 10$ counts
Check the linear input by resetting the calibrator to 0.00V		The resulting indication should be $0 \pm 10$ counts
Check the linearity by setting the calibrator to 2.5V		The resulting indication should be $12500 \pm 20$ counts
Press  to select the next calibration parameter		

The procedure for calibrating the 0-5V secondary voltage input is the same but uses the parameters:

*SLO 5*

*SHD 5*

*SHD 5*

### 8.5 Example 3: To Calibrate the 0-20mA Main Input

Connect a calibrated voltage source the main input terminals as shown.

The procedure is the same as for the above example but uses different parameters and voltage values.

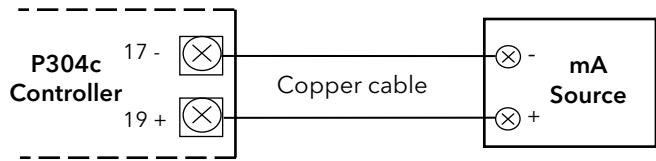

Action	Display	Notes
Press <b>←</b> to scroll to the low calibration point for the 0-20mA main input, <i>PL.020</i>		
Set the mA input source to 0.000mA or 0.00mV or 0.000V (even if the minimum range is 4mA).		Wait a few seconds for the measurement to stabilise
Press <b>▼</b> or <b>▲</b> keys to select On Press <b>←</b> to enter the low calibration mode		The top display will show a decimal point for a few seconds as the input calibrates to the minimum range value.
If successful the display will go to the high calibration point, <i>PH.020</i>		If unsuccessful the display will show Err5 - Input calibration out of range. Check the setting of the current source.
Set the current input source to 20mA		Wait a few seconds for the measurement to stabilise
Press <b>▼</b> or <b>▲</b> keys to select On Press <b>←</b> to enter the high calibration mode		The top display will blank for a few seconds as the input calibrates to maximum range value (20mA).
If successful the display will go to verify, <i>P .020</i>		The upper display shows the number of counts relative to the measured value. the calibration is correct if the number of counts is within $25000 \pm 10$ counts
Check the linear input by resetting the calibrator to 0.00mA		The resulting indication should be $0 \pm 10$ counts
Check the linearity by setting the calibrator to 10.0mA		The resulting indication should be $12500 \pm 20$ counts
Press <b>←</b> to select the next calibration parameter		

The procedure for calibrating the 0-20mA secondary current input is the same but uses the parameters:

*SL.020*

*SH.020*

*SH.020*

### 8.6 Example 4: To Calibrate the Control Output (OUT1) - Voltage

The example is given for 0-10V output.

Connect a calibrated volt meter to the retransmission output terminals 21 and 22.

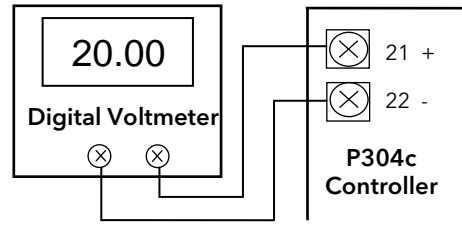

Action	Display	Notes
Press <b>←</b> to scroll to the main analogue output low calibration point, <i>PLVOL</i> .		The upper display should read between 0 and 20000.
Press <b>▼</b> or <b>▲</b> keys to adjust the reading on the output meter for -12.5V ±2mV		The number shown in the upper display is an example only. The instrument memorises this value as zero.
Press <b>←</b> to scroll to the main analogue output high calibration point, <i>PHVOL</i> .		The upper display should read between 0 and 20000.
Press <b>▼</b> or <b>▲</b> keys to adjust the reading on the output meter for +12.50V ±2mV		The number shown in the upper display is an example only. The instrument memorises this value as full scale.
Press <b>←</b> to scroll to the main analogue output verify calibration point, <i>AVOL</i>		With a reading of 0 the voltmeter should show -12.5Vdc. The voltmeter reading will change by 2.5V for every unit change which is made on the instrument. It is not generally necessary to make these checks.
Check the linear calibration by pressing <b>▼</b> or <b>▲</b> keys to modify the value on the upper display from 0 to 10 and check the linearity of the out circuit at 0%, 10% etc to 100% of full scale value		The maximum error must be ±2mV
Press <b>←</b> to select the next calibration parameter		

For a current output substitute the voltmeter for a calibrated ammeter. The following parameters apply:

*PLCUR* The low calibration point should read -5mA

*PHCUR* The high calibration point should read +25mA

*AVOL*

The secondary analogue output (OUT2) may be calibrated the same as the above procedure. Refer to the table in section 8.1 for the relevant parameters.

To leave calibration level, press and hold **⏏** until the *GoTo* display is shown and use the **▼** or **▲** button to select the desired level of operation.

## 9. CPI (Configuration Port Interface)

In addition to the EIA485 digital communications port, the instrument is provided with an internal port which allows field upgrade of the firmware and also configuration and upload/download of the complete instrument parameter set (cloning function).

Do not use this port for any other purposes.

### 9.1 CPI Adaptor

A choice of two configuration clips is available from Eurotherm either of which may be ordered as part of the iTools configuration package or as a separate item:

1. USB CPI Clip which may be ordered quoting part number IToolsNONE-USB. This consists of a cable fitted with a USB interface for the pc and a 5-pin clip which connects to the instrument.

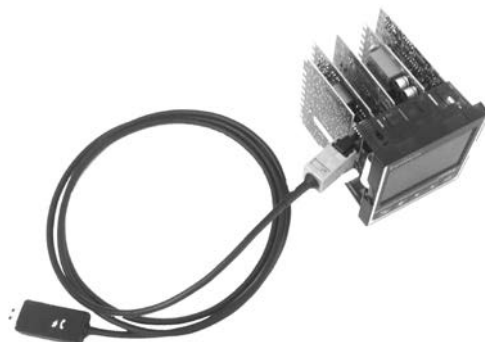

2. A alternative EIA232 9-pin serial port interface clip may be ordered quoting part number IToolsNONE-CK. This consists of a cable fitted with a 9-pin D type connector for the pc serial port, an international power supply (European; US/Japan and UK) and the 5-pin instrument clip.



The 5-pin clip can be connected to the instrument either in or out of its sleeve. It is not necessary to power the instrument since power is supplied through the adaptor.



With the adaptor fitted all functions of the instrument are disabled, and the instrument is put into 'remote' mode. If the instrument is powered up the 'Rem' beacon is lit, but the remainder of the display is blank.

## 9.2 Firmware Update Procedure

The firmware code is stored in a rewritable Flash memory and it can be updated following the below procedure.

### Required tools:

- A PC with serial COM port or with an USB to Serial adapter.
- A CPI (Configuration Port Interface) adapter as shown in the previous section.
- The "Flash Magic" PC tool, available for download at the <http://www.flashmagictool.com> URL.

1. Disconnect the indicator/controller unit from power supply. Enable the boot-loader by linking the SH5 "coffee bean" by means of a soldering iron. This is found at the top of the middle board.  
An alternative is to press and hold the  -  -  keys combination during power-on.
3. Connect the CPI adapter to the PC and to the indicator/controller device.
4. Supply power to the indicator/controller unit trough the CPI power supply or USB port or the terminal block, in no case will the display light up.
5. Download, install and start the "Flash Magic" PC tool, it works on any versions of Windows, except Windows 95. 10Mb of disk space is required.
6. Select in the "Step 1 - Communications" frame:
  - The COM Port being used.
  - The Baud Rate, maximum 115200 Baud.
  - The Device, LPC2364. Some prototypes are fitted with the LPC2366. "Flash Magic" warns about improper device.
  - The Interface, None (ISP).
  - The Oscillator Freq. (MHz),14.748.
7. Check the "Erase all Flash+Code Rd Prot" option.
8. Using the "Browse..." button select the Hex file to download into the device.
9. In the "Step 4 - Options" frame check the "Verify after programming" option and uncheck the other options.
10. Click on the "Start" button to launch the procedure. The bottom bar should report in sequence the messages below:
  - Attempting to connect...
  - Erasing device...
  - Programming device (0x00000000)...
  - Verifying (0x00000000)...
  - Finished
11. Remove power from the indicator/controller unit and disconnect the CPI adapter.
12. Disable the boot-loader by removing the short-circuit on the SH5 "coffee bean".
13. Reconnect the controller unit to the power supply and check the result of the firmware update. Possible error messages on the display may happen due to inconsistency between the updated firmware and the data stored in the non-volatile (EEPROM) memory.

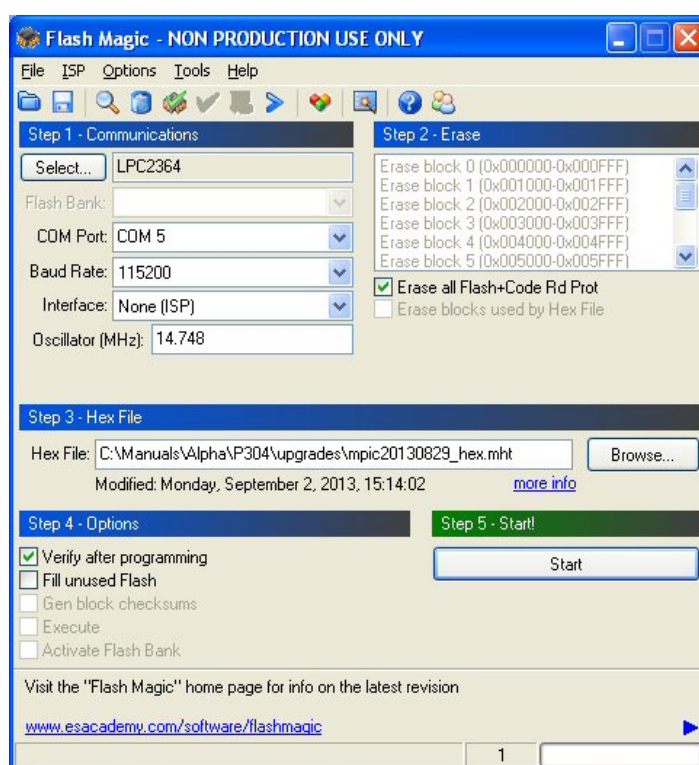

### Troubleshooting

In some rare cases, the "Flash Magic" prompts the "Unable to communicate.... Try raising or lowering the baud rate" message. Retry setting the baud rate to 57600.

## 10. Appendix A Modbus and Jbus Addresses

### 10.1 Multiplier and Decimal figures

Some parameters have a related variable stated as “multiplier”; this system allows the limits of +/- 32767 counts to be overcome.

Example: the measured value 80000 is sent as 1600 and a multiplier of 50.

The host must know the multiplier before writing a value.

The multiplier is chosen by the device (unless pressure input full scale value selection).

Similarly some parameters have a related variable stated as “decimal figures” indicating the decimal point position.

### 10.2 S2K IEEE floating point notation

Some variables are mirrored as a floating point value in the MODBUS IEEE region at 8000h. In this case the address is multiplied by 2 and offset by 8000h. For example, 'Alarm 1 Threshold address of 1105 is IEEE 34978. Two Modbus registers are read and interpreted as a single IEEE value.

When a variable supports this notation the MODBUS IEEE address is indicated in the Variable Address column.

### 10.3 Level 1 and Level 2 Parameters

Mnem.	Parameter	Modbus	Jbus	Range
	Local/remote device status	218	219	0 = local 1 = remote  At power up, each slave is in local mode. In order to enable a slave to be controlled from the master, it is necessary to set the local/remote device status. For a slave to remain in remote status, it is sufficient to detect line activity. If there is no line activity for more than 3 seconds every slave will automatically return to local mode. If remote is issued via CPI port the slave doesn't automatically return to local mode. Local mode: The communication between master and slave is limited to transferring data from slave to master without the possibility of modifying any parameter from the master itself (with the exception of the local/remote device status and the error handling variables). Therefore, from the local keyboard, parameters can be displayed and modified. Remote mode: The instrument parameters can be modified by the master. Therefore, from the instrument front, the parameters can only be displayed but not modified.
<i>SP</i>	SETPOINT	1100	1101	
<i>ALMAS</i>	ALARMS MASK RESET	1101	1102	1 = restore the alarm mask The write of '0' to this address is allowed and has no effect.
<i>A-M</i>	AUTO/MANUAL SELECTION	1104	1105	0 = selection from front panel or serial communication 1 = selection from rear terminal block
<i>LrSP</i>	LOCAL/REMOTE SET POINT SELECTION	1215	1216	0 = local 1 = remote
<i>SPLo</i>	SET POINT LIMIT LOW	1332	1333	
<i>SPHi</i>	SET POINT LIMIT HIGH	1334	1335	
<i>SPrr</i>	SET POINT RAMP			
<i>AL1</i>	ALARM 1 THRESHOLD	1105	1106	See also the example in section 10.2 above.
	Decimal figures assigned to alarm 1 threshold	1106	1107	
	Multiplier assigned to alarm 1 threshold	1107	1108	
<i>A1HS</i>	ALARM 1 HYSTERESIS	1406	1407	
<i>AL2</i>	ALARM 2 THRESHOLD	1108	1109	
<i>A2HS</i>	ALARM 2 HYSTERESIS	1408	1409	
<i>AL3</i>	ALARM 3 THRESHOLD	1111	1112	
<i>A3HS</i>	ALARM 3 HYSTERESIS	1410	1411	

Mnem.	Parameter	Modbus	Jbus	Range
P <sub>1</sub> VAL	PRIMARY PRESSURE INPUT VALUE	1114	1115	Note: When an error is detected on measure the "data" field contains one of these error codes: 30002 (7532h): Open 30003 (7533h): Wrong zero measure 30011 (753Bh): Overload or short-circuit on strain gage power supply 30013 (753Dh): Wrong span measure
S <sub>1</sub> VAL	SECONDARY PRESSURE INPUT VALUE	1116	1117	Note: 30002 (7532h): Open 30003 (7533h): Wrong zero measure 30011 (753Bh): Overload or short-circuit on strain gage power supply 30013 (753Dh): Wrong span measure
LoC	ZERO CALIBRATION	1200	1201	1 = start the zero calibration; allow at least 5 seconds to complete the calibration procedure. The progress and the result of calibration is available in the "Input calibration status" variable. 2 = restore the default value for zero calibration. The write of '0' to this address is allowed and has no effect. Note: Writing 1 is possible only in normal operative mode
Lo2C	ZERO CALIBRATION FOR SECONDARY INPUT	1226	1227	1 = start the zero calibration; allow at least 5 seconds to complete the calibration procedure. The progress and the result of calibration is available in the "Input calibration status" variable. 2 = restore the default value for zero calibration The write of '0' to this address is allowed and has no effect. Note: Writing 1 is possible only in normal operative mode
HiC	SPAN CALIBRATION	1201	1202	1 = start the span calibration (see "Zero calibration" variable) 2 = restore the default value for span calibration The write of '0' to this address is allowed and has no effect. Note: Writing 1 is possible only in normal operative mode
Hi2C	SPAN CALIBRATION FOR SECONDARY INPUT	1227	1228	1 = start the span calibration (see "Zero calibration" variable) 2 = restore the default value for span calibration The write of '0' to this address is allowed and has no effect. Note: Writing 1 is possible only in normal operative mode
TUNE	TUNE	1013	1014	Read value: 0 = inactive 1 = tune, filter compute 2 = tune, step response 3 = adaptive Write value: 0 = Smart function inactive 1 = Smart function active
Pb	PROPORTIONAL BAND	1205	1206	
ti	INTEGRAL TIME	1206	1207	1000 = integral action disabled
td	DERIVATIVE TIME	1208	1209	
IP	INTEGRAL PRE LOAD	1210	1211	
oPHi	CONTROL OUTPUT LIMITER	1328	1329	
Ctrl	TYPE OF CONTROL	1212	1213	0 = Proportional + Integral 1 = Proportional + Integral + Derivative
Ctrl FL	FILTER FOR DISPLAY AND CONTROLLER	1214	1215	0 = 0 s (no filter) 1 = 0.5 s 2 = 1 s 3 = 2 s 4 = 4 s 5 = 8 s 6 = 16 s
ASb	AUTOMATIC STAND-BY	1223	1224	0: function disabled



Mnem.	Parameter	Modbus	Jbus	Range
				1: function enabled
<i>ASbPL</i>	AUTOMATIC STAND-BY PRESSURE LOW LIMIT	1224	1225	
<i>ASbrt</i>	AUTOMATIC STAND-BY RECOVERY TIME	1225	1226	61: no timeout applied
<i>A1FL</i>	ALARM 1 FILTER	1217	1218	0 = 0 s (no filter)
<i>A2FL</i>	ALARM 2 FILTER	1218	1219	1 = 0.4 s
<i>A3FL</i>	ALARM 3 FILTER	1219	1220	2 = 1 s
<i>roFL</i>	RETRANSMISSION OUTPUT FILTER	1222	1223	3 = 2 s
				4 = 3 s
				5 = 4 s
				6 = 5 s
<i>AtStP</i>	STEP FOR TUNE FUNCTION	1203	1204	
<i>At, P</i>	AUTOMATIC SELECTION OF THE INTEGRAL PRE LOAD VALUE	1211	1212	0 = manual selection 1 = automatic selection
<i>AtAFL</i>	AUTOMATIC SELECTION OF THE FILTER TIME CONSTANT	1213	1214	0 = manual selection 1 = automatic selection before Tune operation
<i>SPrr</i>	SET POINT RAMP	1417	1418	
<i>Att0</i>	PROCESS TIME DELAY	1900	1901	
<i>AtPt</i>	PROCESS TIME CONSTANT	1901	1902	
<i>AtPG</i>	PROCESS GAIN	1902	1903	
<i>Att1</i>	START TIME OF TUNE FUNCTION	1903	1904	
<i>Att2</i>	STOP TIME OF TUNE FUNCTION	1904	1905	
<i>AtAdS</i>	ADAPTIVE STEP	1906	1907	

### Configuration Parameters

Code	Description	Modbus	Jbus	Range																
P1	PRESSURE INPUT SELECTION	1500	1501	0 = strain gage 1 = 0-20 mA 2 = 4-20 mA 3 = 0-5 V 4 = 0-10 V																
P2	PRESSURE INPUT ENGINEERING UNIT	1339	1340	Off kg/cm <sup>2</sup> psi bar MPa																
P3	PRESSURE INPUT FULL SCALE VALUE	1301	1302	The permissible write value depends from the previously sent pressure input multiplier:																
				Multiplier	Full scale value	Permissible variable value														
				1	10.. 4000	10..4000														
				2	4002.. 8000	2001..4000														
				5	8005..20000	1601..4000														
				10	20010..40000	2001..4000														
				20	40020..80000	2001..4000														
				50	80050..99950	1601..1999														
P4	PRESSURE INPUT LOW SCALE VALUE	1302	1303																	
P5	PRESSURE INPUT DECIMAL POINT POSITION	1303	1304	Decimal figures assigned to pressure input full scale value, displayed input variable, instantaneous input variable, operative set point value, peak value, deviation value, set point, remote set point input range low, remote set point input range high, retransmission output range low, retransmission output range high, set point limit low, set point limit high, set point ramp, secondary pressure input full scale value, primary input pressure value, secondary input pressure value.																
P6	PRESSURE INPUT FAIL SAFE	1403	1404	0 = high 1 = low	<p>P6 is used to determine the alarm action in the event of loss of the sensor (for example, the sensor becomes disconnected). The action is best described in the table (using Alarm 1 as the example):</p> <table border="1"> <thead> <tr> <th>P6</th> <th>Alarm 1 (set by P62)</th> <th>Alarm state</th> </tr> </thead> <tbody> <tr> <td>Hi</td> <td>Hi</td> <td>On</td> </tr> <tr> <td>Lo</td> <td>Hi</td> <td>Off</td> </tr> <tr> <td>Hi</td> <td>Lo</td> <td>Off</td> </tr> <tr> <td>Lo</td> <td>Lo</td> <td>On</td> </tr> </tbody> </table> <p>In all cases the display will indicate <b>OPEN</b>.</p>	P6	Alarm 1 (set by P62)	Alarm state	Hi	Hi	On	Lo	Hi	Off	Hi	Lo	Off	Lo	Lo	On
				P6		Alarm 1 (set by P62)	Alarm state													
				Hi		Hi	On													
				Lo		Hi	Off													
				Hi		Lo	Off													
				Lo		Lo	On													
P7	SHUNT CALIBRATION	1400	1401	0 = shunt calibration disabled 1 = shunt calibration enabled																
P8	SHUNT VALUE	1401	1402																	
P9	PRESSURE INPUT DISPLAY UPDATE TIME	1426	1427	0 = 0.050 s 1 = 0.100 s 2 = 0.250 s 3 = 0.400 s																
P11	SECONDARY INPUT SELECTION	1502	1503	0 = input disabled 1 = 0-20 mA 2 = 4-20 mA 3 = 0-5 V 4 = 0-10 V 5 = strain gauge																
P12	SECONDARY INPUT FUNCTION	1507	1508	0 = remote setpoint 1 = second sensor for differential pressure measurement																
P19	SECONDARY INPUT FULL	1340	1341																	

	SCALE VALUE			
P20	SECONDARY INPUT LOW SCALE VALUE	1341	1342	
P21	SECONDARY INPUT FAIL SAFE	1404	1405	0 = high 1 = low
P22	REMOTE SET POINT INPUT RANGE LOW	1304	1305	
P23	REMOTE SET POINT INPUT RANGE HIGH	1305	1306	
P24	SECONDARY INPUT SAMPLE TIME	1427	1428	0 = 0.050 s 1 = 0.100 s 2 = 0.250 s 3 = 0.400 s
P35	CONTROL OUTPUT SELECTION	1503	1504	1 = 0/20 mA 2 = 4/20 mA 3 = 0/10 V 4 = -10/10 V 5 = 0/5 V
P36	CONTROL OUTPUT RANGE LOW	1327	1328	
P37	CONTROL OUTPUT RANGE HIGH	1328	1329	
P38	CONTROL OUTPUT DECIMAL POINT POSITION	1329	1330	
P39	CONTROL OUTPUT MANUAL MODE INDICATION	1420	1421	0 = percentage 1 = RPM
P40	DIRECT/REVERSE SELECTION FOR CONTROL OUTPUT	1421	1422	0 = reverse + direct 1 = reverse + reverse 2 = direct + direct 3 = direct + reverse
P55	RETRANSMISSION OUTPUT SELECTION	1504	1505	0 = output disabled 1 = 0/20 mA 2 = 4/20 mA 3 = 0/10 V 4 = -10/10 V 5 = 0/5 V
P56	RETRANSMISSION OUTPUT RANGE LOW	1330	1331	
P57	RETRANSMISSION OUTPUT RANGE HIGH	1331	1332	
P61	ALARM 1 INPUT CHANNEL LINK	1311	1312	0 = alarm disabled 1 = process alarm 2 = band alarm 3 = deviation alarm
P62	ALARM 1 TYPE	1312	1313	0 = high alarm 1 = low alarm 2 = low alarm with mask at start-up
P63	ALARM 1 RESET MODE	1407	1408	0 = automatic reset 1 = manual reset
P64	ALARM 1 FAILSAFE MODE	1423	1424	0: failsafe mode 1: non-failsafe mode
P65	ALARM 2 INPUT CHANNEL LINK	1313	1314	As P61
P66	ALARM 2 TYPE	1314	1315	As P62
P67	ALARM 2 RESET MODE	1409	1410	As P63
P68	ALARM 2 FAILSAFE MODE	1424	1425	As P64
P69	ALARM 3 INPUT CHANNEL LINK	1315	1316	As P61

P70	ALARM 3 TYPE	1316	1317	As P62
P71	ALARM 3 RESET MODE	1411	1412	As P63
P72	ALARM 3 FAILSAFE MODE	1425	1426	As P64
P81	LOGIC INPUT CONFIGURATION This parameter configure the logic input on terminals 23 and 24	1413	1414	0 = input disabled 1 = alarm reset 2 = peak reset 3 = alarm and peak reset 4 = zero calibration 5 = zero calibration, alarm and peak reset
P82	LOGIC INPUT STATUS	1414	1415	0 = input active when contact is closed 1 = input active when contact is open
P83	PEAK DETECTION	1415	1416	0 = disabled 1 = peak high 2 = peak low
P84	LINE FREQUENCY	1422	1423	0 = 50 Hz 1 = 60 Hz 2 = Auto
P85	LINE FREQUENCY READOUT	1428	1429	0 = 50 Hz 1 = 60 Hz 2 = Undefined line frequency: default 50Hz 3 = Undefined line frequency: default 60Hz
P86	MANUAL/AUTO START UP	1334	1335	0 = start-up in automatic mode 1 = start-up in manual mode
P87	MANUAL/AUTO TRANSFER	1416	1417	0 = without set point modification 1 = with set point modification
P91	SERIAL COMMUNICATION INTERFACE ADDRESS	1335	1336	0 = serial communication interface disabled 1..255 = serial communication interface address Note: The changes related to serial communication interface parameters will be effective after the end of the reply's transmission.
P92	PROTOCOL TYPE	1336	1337	0 = Modbus 1 = Jbus
P93	COMMUNICATION TYPE	1337	1338	0 = 8 bit 1 = 8 bit + even parity bit 2 = 8 bit + odd parity bit
P94	COMMUNICATION BAUD RATE	1338	1339	0 = 600 baud 1 = 1200 baud 2 = 2400 baud 3 = 4800 baud 4 = 9600 baud 5 = 19200 baud
P98	LEVEL 2 PASS CODE	2003	2004	
P99	CONFIGURATION PASS CODE	2004	2005	
rECL	RECOVERY POINT	2100	2101	

## 10.4 Other Parameters

Code	Description	Modbus	Jbus	Range
	Alarm 1 Status	1008	1009	0: no alarm condition 1: alarm condition
	Alarm 2 Status	1009	1011	
	Alarm 3 Status	1011	1012	
	Auto/manual selection	1104	1105	0 = selection from front panel or serial communication 1 = selection from rear terminal block
	Displayed input variable (PV)	1000	1001	When an error is detected on measure the "data" field contains one of these error codes: 30002 (7532h): Open 30003 (7533h): Wrong zero measure 30011 (753Bh): Overload or short-circuit on strain gage power supply 30013 (753Dh): Wrong span measure
	Instantaneous input variable	1001	1002	
	Primary input pressure value	1114	1115	
	Secondary input pressure value	1115	1116	
	Alarm and peak reset	2101	2102	1 = alarm reset 2 = peak reset 3 = alarm and peak reset The write of '0' to this address is allowed and has no effect.
	Automatic/manual mode status	1014	1015	0 = automatic mode 1 = manual mode
	Peak Value	1002	1003	When an error is detected on measure the "data" field contains one of these error codes: 30002 (7532h): Open

## 11. Appendix B TECHNICAL SPECIFICATION

General		Power Supply requirements	
<b>Environmental performance</b>		High voltage	100 to 230Vac, +/-15%
Temperature limits	Operation: 0 to 50°C (32 to 122°F), Storage: -20 to 70°C (-4 to 158°F)	Low voltage	50 to 60Hz 24Vac, (14 to 32Vac) 50/60Hz 24Vdc, (14 to 32Vdc) ±5% ripple voltage,
Humidity limits	Max 85% non-condensing Storage: RH: 5 to 90% non-condensing	Power consumption	22VA max at 50Hz, 27W max at 60Hz. 18VA max at 24Vac; 12W max at 24Vdc.
Altitude	<2000 metres (6562ft).	<b>Pressure Input</b>	
Atmospheres	Not suitable for use in explosive or corrosive atmospheres.	Primary input	keyboard selectable between strain gauge and linear.
<b>Electromagnetic compatibility (EMC)</b>		Linear input	selectable 0-5Vdc, 0-10Vdc, 0-20mA, 4- 20mA.
Emissions and immunity	EN61326-1 Suitable for light industrial as well as heavy industrial environments.	Input impedance	< 10 Ω for linear current input > 165 kΩ for linear voltage input.
<b>Electrical safety</b>		Input protection	open circuit detection for strain gauge (on signal and excitation wires) and 4-20 mA inputs; not available for 0-5Vdc, 0- 10Vdc and 0-20mA. Keyboard programmable
EN61010	Installation category II; Pollution degree 2	Sampling time	50 ms typical. 50 ms typical is also valid for the differential pressure input.
Installation category II	The rated impulse voltage on nominal 230V supply is 2500V	Display update time	selectable 50, 100, 250 or 400 ms
Pollution degree 2	Normally only non conductive pollution occurs. Occasionally, however, a temporary conductivity caused by condensation may be expected.	Engineering units	dedicated beacons within the display window.
<b>Physical</b>		Calibration mode	Field calibrations (zero and span) are applicable for both strain gauge and linear input. Field calibration can be deleted and original factory values restored.
Case	PC colour black, self-extinguishing degree V0 according to UL94.	Input resolution	4000 counts.
Dimensions	DIN 43700 96x96mm	Full scale value	Resolution
Panel mounting	1/4 DIN	10/4000	1 count
Weight	650 grams	4002/8000	2 counts
Panel cut-out	92 x 92mm	8005/20000	5 counts
Panel depth	128 mm	20010/40000	10 counts
Rear terminals	Screw terminals with safety cover	40020/80000	20 counts
<b>Keypad and Display</b>		80050/99950	50 counts
Keypad	Five pushbuttons membrane	Decimal point:	Settable in any position of the display
Display	LED	<b>Digital Inputs</b>	
Upper digits	Green colour, 5 numeric digits, 7 segments with decimal point, 13.3 mm high	Fixed input.	One input from contact closure (voltage free).
Lower digits	Amber colour, 5 numeric digits, 7 segments with decimal point, 10.7 mm high	Terminals 23 and 24	Keyboard programmable for alarm reset, peak reset, alarm and peak reset, zero calibration of the primary input, zero calibration of the primary input + alarm + peak reset. Access to parameters by front keyboard is inhibited while zero calibration is running.
Bar graph	Green colour, 35 segment with 3% resolution. Display continuous to indicate the measured variable (0-100% full scale. Alarm set point values displayed. First segment blinks for pressure lower than zero. Last segment blinks for pressure greater than full scale value.	DIG1 to DIG4	Opto-isolated with respect to the CPU and analogue inputs
Status beacons	Units, outputs, alarms, active setpoint	<b>Analogue Input Common Specification</b>	
<b>Approvals</b>		Common mode rejection ratio	> 120 dB @ 50/60 Hz
Agency	cUL	Normal mode rejection ratio	> 60 dB @ 50/60 Hz
Self certification	CE		
<b>Transmitter Power Supply (TPSU)</b>			
Isolation	isolated from inputs and outputs		
Output Voltage	24Vdc, +/-2%; 1.5W for two or four wire transmitters (optional).		

Strain gauge input	from 340 to 5000 ohm, 1-4 mV/V. Excitation 10V +/- 7%. 5 wire connection. Interfacing 1mV/V sensors could worsen the noise performance
Input signal	-25/125% of full scale (approximately -10/50mV
Shunt calibration	with or without shunt resistor (programmable 40.0 to 100.0%) - main and secondary inputs when differential pressure measurement is selected.
Zero balance	$\pm 25\%$ of full scale (approx. $\pm 10\text{mV}$ )
Reference accuracy	+/- 0.1% fsv +/- 1 digit @ 25 +/- 1 °C and nominal power supply voltage
Temperature drift operational	< 300 ppm/K of full span for current, voltage and strain gauge input
Zero and span calibration	For differential inputs, there is no relation between the calibration of the two single sensors; each input is provided with its own zero and span calibration parameters.
Wiring caution	The analogue input lines cannot exceed the 30 meter length or exit the building.

### Alarms

Alarm outputs	3 standard alarms
AL1 and AL2 contacts	1 SPDT 2 A max @ 240VAC resistive load
AL3 contacts:	1 SPST solder jumper selectable NO/NC 2 A max @ 240VAC resistive load
Contact protections	Varistor for spikes protection.
Type	Each alarm is keyboard programmable for - Process variable / Deviation / Band - High / Low / Low masked on start up - Auto / Latching reset mode
Excitation type	Keyboard configurable for each alarm: relay coil energized in no alarm condition (failsafe) or relay coil energized in alarm condition (non-failsafe).
Threshold	From 0 to 110% Full Scale (the threshold may be limited due to the selected full scale value).
Hysteresis	Keyboard programmable for each alarm; from 0.1% to 10.0% of span or 1 LSD (whichever is greater) for each alarm.
Filter	Selectable from the following values for each alarm OFF, 0.4, 1, 2, 3, 4, 5 sec.
Update time	At every input conversion

### Modbus Serial Communications

Interface	Optional, EIA-485 type, opto-isolated
Protocol type	Modbus/Jbus (RTU mode).
Type of parameters	Run-time and configuration. Both are available by serial link
Configuration software	Through a dedicated PC software application package
Device address	From 1 to 255
Baud rate:	600 up to 19200 baud
Format	1 start bit, 8 bit with/without parity, 1 stop bit
Parity	Even/Odd

### Analogue Output Control

Isolation	Opto-isolated from CPU, input and output circuits
Type of output	Keyboard selectable:- • 0/10 VDC min. load 5 kohm

Resolution	0.1% in manual mode, 0.03% in automatic mode
Scaling	The output control value may be displayed in two modes - from 0.0 to 100.0 % (0.1% resolution) - from a low to a high limits selectable from -10000 to 10000
Output limits	From 0 to 100 % of full scale; no under-range or over-range is allowed

### Analogue Output Retransmission

Isolation	Opto-isolated from CPU input and output circuits
Type of output	Keyboard selectable:- • 0/10 VDC min. load 5 kohm, with under/over-range capability from -2.5 to 12.5 V. • -10/+10 VDC min. load 5 kohm, with under/over-range capability from -12.5 to 12.5 V. • 0/5 VDC min. load 5 kohm, with under/over-range capability from -1.25 to 6.25 V. • 0/20 mA max. load 500 ohm, with under/over-range capability from -5 to 25 mA (max. load 400 ohm over 20 mA). • 4/20 mA max. load 500 ohm, with under/over-range capability from 0 to 24 mA (max. load 400 ohm over 20 mA).
Resolution	0.1% of output span.
Scaling	Low and high limits are freely selectable from 0 to pressure input full scale value. This allows direct or reverse output type.
Filter	Selectable from the following values for each alarm OFF, 0.4, 1, 2, 3, 4, 5 sec.

### Analogue Output Common Specification

Reference accuracy	+/- 0.1% of output span @ 25 +/- 1°C and nominal line voltage
Linearity error	< 0.1% of output span
Output noise	< 0.1% of output span

### Control Algorithm

Type	PID plus Integral Preload plus Anti Reset Windup.
Output value indication	Selectable between the following modes - range 0/100.0%. - scaleable with two proper values for RPM indication In automatic mode both modes are available (not at the same time). In manual mode a parameter is provided to select the first or second method of indication.
Tune algorithm	Two types selectable - one shot self tune - adaptive
Automatic stand-by	This function avoids overshoot due to temporary process interruptions (PV goes to zero).

## 12.Index

Alarms	
Band.....	24
Deviation.....	25
Process.....	23
Alarms:	23
Ambient temperature.....	4, 14
Analogue.....	10
Auto mode.....	22
Calibration.....	16, 27, 44, 45, 46, 47, 48, 49, 50
Cleaning.....	14
Conductive pollution.....	14
Control Type.....	29
DC.....	36
diagnostic mode.....	15
Digital Communications.....	3, 23, 28, 38, 43
Digital Input.....	11, 18
EIA485.....	3, 13, 28, 38, 43, 51
Electromagnetic compatibility.....	14
Electrostatic.....	14
EMC.....	4, 14
end.....	45
fuse.....	7
Grounding.....	14
humidity.....	4, 14
Input.....	8, 9, 30, 31, 32, 36, 47, 48, 49
Input Type.....	32
Installation.....	3, 4, 14
Integral.....	40, 41
Internet Site	
UK.....	4, 13, 43
Isolation Boundaries.....	6
latching ears.....	4
Level 1.....	16, 17, 21
Level 1 Parameters	
ALARM 1 THRESHOLD.....	17, 19, 23, 24, 25
ALARM 2 THRESHOLD.....	17, 19, 23
ALARM 3 THRESHOLD.....	17, 19, 23
ALARMS MASK RESET.....	17, 19, 26
PRIMARY PRESSURE INPUT VALUE.....	17, 20
SECONDARY PRESSURE INPUT VALUE.....	17, 20
SETPOINT.....	15, 16, 17, 19, 24, 25, 28, 40
Level 2 Parameters	
ADAPTIVE STEP.....	21
ALARM 1 FILTER.....	20
ALARM 1 HYSTERESIS.....	19, 24, 25
ALARM 1 THRESHOLD.....	17, 19, 23, 24, 25
ALARM 2 FILTER.....	20
ALARM 2 HYSTERESIS.....	19
ALARM 2 THRESHOLD.....	17, 19, 23
ALARM 3 FILTER.....	20
ALARM 3 HYSTERESIS.....	19
ALARM 3 THRESHOLD.....	17, 19, 23
ALARMS MASK RESET.....	17, 19, 26
AUTO/MANUAL SELECTION.....	17, 18, 19
AUTOMATIC SELECTION OF THE FILTER TIME CONSTANT.....	21
AUTOMATIC SELECTION OF THE INTEGRAL PRE LOAD VALUE.....	21
AUTOMATIC STAND-BY.....	20, 42
AUTOMATIC STAND-BY PRESSURE LOW LIMIT.....	20, 42
AUTOMATIC STAND-BY RECOVERY TIME.....	20
CONTROL OUTPUT LIMITER.....	20
DERIVATIVE TIME.....	20
FILTER FOR DISPLAY AND CONTROLLER.....	20
INTEGRAL PRE LOAD.....	20
INTEGRAL TIME.....	20, 41, 42
LOCAL/REMOTE SET POINT SELECTION.....	16, 19
PRIMARY PRESSURE INPUT VALUE.....	17, 20
PROCESS GAIN.....	21
PROCESS TIME CONSTANT.....	21
PROCESS TIME DELAY.....	21
PROPORTIONAL BAND.....	20
SECONDARY PRESSURE INPUT VALUE.....	17, 20
SET POINT LIMIT HIGH.....	17, 19
SET POINT LIMIT LOW.....	19
SET POINT RAMP.....	19
SETPOINT.....	15, 16, 17, 19, 24, 25, 28, 40
SPAN CALIBRATION.....	20, 27
SPAN CALIBRATION FOR SECONDARY INPUT.....	20, 27
START TIME OF TUNE FUNCTION.....	21
STEP FOR TUNE FUNCTION.....	20
STOP TIME OF TUNE FUNCTION.....	21
TIME OF TUNE FUNCTION.....	20, 21
TUNE.....	20
TYPE OF CONTROL.....	20
ZERO CALIBRATION.....	20, 27
ZERO CALIBRATION FOR SECONDARY INPUT.....	20, 27
Logic.....	30, 36
Manual.....	12, 15, 18, 19, 22, 30, 36, 37
Modbus.....	3, 13, 38, 43
Mounting.....	4
Open.....	16
Order Code.....	5, 7
Panel.....	4
Panel retaining clips.....	4
Personnel.....	14
Pollution.....	14
Power Supply.....	7
Recovery.....	30, 39
Recovery Point.....	39
Relay.....	14, 23, 28, 35
Reset.....	11, 15, 23, 35, 36
Resistor.....	8, 9, 27
Retransmission.....	10, 30, 34
RTD.....	44, 45
Safety.....	14
Scroll.....	15
Sensor Input.....	8
Spacing.....	4
Specification.....	59
start up.....	17, 19, 26, 35, 37, 42
Terminal.....	6
Thermocouple.....	44, 45
Transmitter.....	8, 9
Tuning.....	42
Wire Sizes.....	6
Wiring.....	6, 14





**EUROTHERM: INTERNATIONAL SALES AND SUPPORT**  
**WWW.EUROTHERM.COM**

**Contact Information**

Eurotherm Head Office  
Faraday Close,  
Durrington,  
Worthing, West Sussex,  
BN13 3PL

Sales Enquiries  
T +44 (01903) 695888  
F 0845 130 9936

General Enquiries  
T +44 (01903) 268500  
F 0845 265982

Worldwide Offices  
[www.eurotherm.com/global](http://www.eurotherm.com/global)



Scan for local contacts

*Represented by:*

© Copyright Eurotherm S.r.l. 2014

All rights are strictly reserved. Reproduction, distribution or storage of this document in any manner is prohibited without prior written consent from Eurotherm. Information in this document may change without notice and is intended for guidance only. Eurotherm will accept no responsibility for any losses arising from errors in this document.