



MODEL 2216e TEMPERATURE CONTROLLER

INSTALLATION AND OPERATION HANDBOOK

Contents	Page
Chapter 1 OPERATION	1-1
1.1 FRONT PANEL LAYOUT	1-2
1.2 GETTING STARTED	1-4
1.2.1 Viewing The Process Value and Setpoint	1-4
1.2.2 To Adjust The Setpoint	1-4
1.2.3 Viewing The Display Units	1-5
1.2.4 Use Of The "SCROLL" Button 	1-5
1.2.5 Use Of The 'PAGE' Button 	1-6
PARAMETER LISTS	1-7
1.4 MANUAL OR AUTOMATIC CONTROL	1-8
1.4.1 Selecting Auto/Manual Operation	1-8
1.4.2 How To Manually Adjust Output Power	1-9
1.5 SUMMARY	1-9
1.6 SETPOINT 1 OR SETPOINT 2	1-10
1.6.1 To Select Setpoint 1 or Setpoint 2	1-10
1.7 RAMP DWELL FUNCTION	1-11
1.7.1 To Set up a Ramp/Time Program	1-11
1.7.2 To Run the Program	1-12
1.7.3 Power Failure During Program Run	1-12
1.8 LOCATION OF PARAMETERS - BLOCK DIAGRAM	1-13
1.9 NAVIGATION DIAGRAM (Part A)	1-14
NAVIGATION Diagram (Part B)	1-15
1.10 PARAMETER TABLES	1-16
1.10.1 HOME Display	1-16
1.10.2 Alarm List	1-17
1.10.3 Autotune List	1-17
1.10.4 PID List	1-18
1.10.5 Setpoint List	1-19
1.10.6 Input List	1-20
1.10.7 On/Off List	1-20
1.10.8 Output List	1-21
1.10.9 Communications List	1-21
1.10.10 Access List	1-21

1.11	ALARMS	1-22
1.11.1	Types of Alarm Used in the 2200.....	1-22
1.12	ALARM RELAY OUTPUT	1-23
1.12.1	SETTING ALARM LEVELS.....	1-24
1.12.2	ALARM INDICATION AND ACKNOWLEDGEMENT	1-25
1.12.3	DIAGNOSTIC ALARMS	1-26
 Chapter 2 INSTALLATION		 2-1
2.1	INSTRUMENT LAYOUT	2-2
2.1.1	Outline dimensions Model 2216e	2-3
2.2	INTRODUCTION	2-4
2.2.1	Controller labels.....	2-4
2.3	MECHANICAL INSTALLATION	2-4
2.3.1	Unplugging and plugging-in the controller	2-4
2.4	WIRING	2-5
2.4.1	Wire Sizes	2-5
2.4.2	Wiring connections.....	2-5
2.4.3	Sensor input connections	2-6
2.4.4	Outputs 1 and 2 connections.....	2-6
2.5	PDS MODES	2-7
2.6	SNUBBERS	2-7
2.7	TYPICAL SINGLE LOOP WIRING DIAGRAM	2-8
2.8	COMMUNICATION CONNECTIONS	2-9
2.8.1	Wiring of EIA-485 serial communication links	2-10
2.9	DEVICENET WIRING TO SERIES 2200E CONTROLLERS	2-11
2.9.1	DeviceNet Terminal Functions	2-11
2.9.2	Wiring Interconnections for DeviceNet Communications	2-12
 Chapter 3 ACCESS LEVELS		 3-1
3.1	THE DIFFERENT ACCESS LEVELS	3-2
3.2	SELECTING AN ACCESS LEVEL	3-3
3.1.1	Returning to Operator Level	3-5
3.3	EDIT LEVEL	3-5
3.1.2	Setting operator access to a parameter	3-5
3.1.3	Hiding or revealing a complete list.....	3-6
3.1.4	Promoting a parameter.....	3-6

4.	Chapter 4 TUNING	4-1
4.1.	WHAT IS TUNING?	4-2
4.2.	AUTOMATIC TUNING	4-3
4.2.1.	Heating and Cooling Output Cycle Times	4-3
4.3.	HOW TO TUNE	4-4
4.3.1.	Typical automatic tuning cycle	4-5
4.3.2.	Calculation of the cutback values	4-5
4.4.	MANUAL TUNING	4-6
4.4.1.	Setting the cutback values	4-7
4.4.2.	Integrating action and manual reset	4-8
4.4.3.	Automatic droop compensation (Adc)	4-8
5.	Chapter 5 CONFIGURATION	5-1
5.1	SELECTING CONFIGURATION LEVEL	5-2
5.2	SELECTING A CONFIGURATION PARAMETER	5-3
5.3	LEAVING CONFIGURATION LEVEL	5-3
5.4	STEPS INVOLVED IN CONFIGURING A CONTROLLER	5-3
5.5	NAVIGATION DIAGRAM (PART A)	5-4
5.6	NAVIGATION DIAGRAM (PART B)	5-5
5.7	CONFIGURATION PARAMETER TABLES	5-6
5.8	CONFIGURATION OF DIGITAL COMMUNICATIONS	5-14
5.8.1.	To Configure the Function and Baud Rate	5-14
5.8.2.	To Set Instrument Address	5-15
5.9	DEVICENET	5-15
5.9.1.	The EDS File	5-15
5.9.2.	ODVA Compliance	5-15
6	Chapter 6 USER CALIBRATION	6-1
6.8	WHAT IS THE PURPOSE OF USER CALIBRATION?	6-2
6.9	USER CALIBRATION ENABLE	6-3
6.10	SINGLE POINT CALIBRATION	6-4
6.11	TWO POINT CALIBRATION	6-5
6.12	CALIBRATION POINTS AND CALIBRATION OFFSETS	6-6

7 Chapter 7 ALARM CONFIGURATION.....7-1

7.1 DEFINITION OF ALARMS AND EVENTS7-2

7.1.1 Types Of Alarms 7-2

7.2 DIGITAL OUTPUT FUNCTIONS7-4

7.3 STEP1 - CONFIGURING THE FOUR ‘SOFT’ ALARMS.....7-5

7.4 STEP 2 - ATTACHING AN ALARM TO A PHYSICAL OUTPUT7-6

7.5 STEP 3 - GROUPING ALARMS ON A SINGLE OUTPUT.....7-7

7.6 STEP 4 - REMOVING ALARMS FROM AN OUTPUT7-7

8. Chapter 8 MOTORISED VALVE CONTROL8-1

8.1. PARAMETERS FOR MOTORISED VALVE CONTROL8-2

8.2. COMMISSIONING THE MOTORISED VALVE CONTROLLER8-2

8.2.1. Adjusting the minimum on-time ‘On t_H’ 8-2

8.3. MOTORISED VALVE APPLICATIONS8-3

8.3.1. Auto Tuning 8-3

8.3.2. Valve Positioner Set-up Table 8-3

Chapter 9 LOAD CURRENT MONITORING & DIAGNOSTICS

9.1 LOAD CURRENT MONITORING AND DIAGNOSTICS 9-2

9.2 EXAMPLE WIRING DIAGRAM (MODE 1 & 2 OPERATION) 9-3

9.3 OPERATION 9-4

To Read Load Current (mode 2 only)9-4

9.3.2 To Display Load Current Continuously in the Lower Readout (mode 2 only) **Error! Bookmark not defined.**

9.3.3 Display Modes.....9-4

9.3.4 How Heater Alarms Are Displayed.....9-5

9.4 TO SET THE ALARM TRIP LEVELS 9-6

9.5 RELAY OUTPUTS 9-6

9.6 TO CONFIGURE PDS LOAD CURRENT DIAGNOSTICS..... 9-7

9.6.1 To Configure the Logic Module for PDS modes 1 or 2.....9-7

To Configure Low and High Current Trip Alarms9-8

9.6.3 To Attach Soft Alarms To A Relay Output.....9-9

9.6.4 The Scaling Factor9-10

9.6.5 To Adjust The Scaling Factor9-10

10 Chapter 10 RETRANSMISSION.....10-1

10.1 WHAT IS RETRANSMISSION..... 10-2

10.2 TO CONFIGURE RETRANSMISSION 10-3

10.3 SCALING RETRANSMITTED OUTPUT SIGNALS..... 10-4

10.1.1 To Range Retrasmitted Output OP 10-4

10.1.2 To Range Retrasmitted Setpoint SP or Process Variable PV .. 10-5

10.1.3 To Range Retrasmitted Error Err 10-5

Appendix A UNDERSTANDING THE ORDERING CODE A-1

Appendix B SAFETY and EMC INFORMATION B-1

This product is covered by one or more of the following US Patents:
 5,484,206 and 5,793,754; Additional patents pending.

PDSIO® is a registered trademark of Eurotherm.

INSTANT ACCURACY™, SSRx Load Doctor™ and SSRx Enhanced Load Doctor™ are trademarks of Eurotherm.”

Symbols in Use In This Handbook



Useful information



Button Operation



Caution, (refer to the accompanying documents)



Functional earth (ground) terminal

Chapter 1 OPERATION

1.1 FRONT PANEL LAYOUT 2

1.2 GETTING STARTED..... 4

 1.2.1 Viewing The Process Value and Setpoint 4

 1.2.2 To Adjust The Setpoint..... 4

 1.2.3 Viewing The Display Units..... 5

 1.2.4 Use Of The “SCROLL” Button  5

 1.2.5 Use Of The ‘PAGE’ Button  6

PARAMETER LISTS..... 7

1.4 MANUAL OR AUTOMATIC CONTROL 8

 1.4.1 Selecting Auto/Manual Operation..... 8

 1.4.2 How To Manually Adjust Output Power 9

1.5 SUMMARY 9

1.6 SETPOINT 1 OR SETPOINT 2 10

 1.6.1 To Select Setpoint 1 or Setpoint 2..... 10

1.7 RAMP DWELL FUNCTION..... 11

 1.7.1 To Set up a Ramp/Time Program 11

 1.7.2 To Run the Program 12

 1.7.3 Power Failure During Program Run 12

1.8 LOCATION OF PARAMETERS - BLOCK DIAGRAM..... 13

1.9 NAVIGATION DIAGRAM (Part A)..... 14

NAVIGATION Diagram (Part B)..... 15

1.10 PARAMETER TABLES..... 16

 1.10.1 HOME Display 16

 1.10.2 Alarm List..... 17

 1.10.3 Autotune List..... 17

 1.10.4 PID List 18

 1.10.5 Setpoint List..... 19

 1.10.6 Input List 20

 1.10.7 On/Off List..... 20

 1.10.8 Output List 21

 1.10.9 Communications List 21

 1.10.10 Access List 21

1.11 ALARMS 22

 1.11.1 Types of Alarm Used in the 2200 22

1.12 ALARM RELAY OUTPUT..... 23

 1.12.1 SETTING ALARM LEVELS..... 24

 1.12.2 ALARM INDICATION AND ACKNOWLEDGEMENT 25

 1.12.3 DIAGNOSTIC ALARMS..... 26

1.1 FRONT PANEL LAYOUT

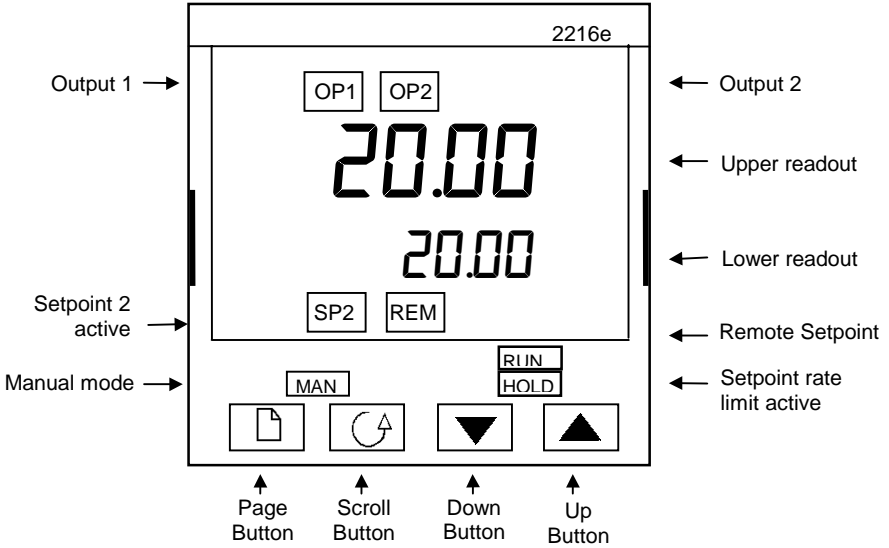

Figure 1-1 Model 2216e front panel layout





Button or indicator	Name	Explanation
OP1	Output 1	When lit, it indicates that heating output is on.
OP2	Output 2	When lit, it indicates that cooling output is on.
SP2	Setpoint 2	When lit, this indicates that Setpoint 2 has been selected.
REM	Remote Setpoint	When lit, this indicates that the PDS remote Setpoint input has been selected. 'REM' is also used to indicate that user comms is active.
MAN	Manual light	When lit, it indicates that manual mode has been selected
RUN	Run light	When lit, it indicates that Setpoint rate limit is active.
	Page button	Press to select a new list of parameters.
	Scroll button	Press to select a new parameter in a list.
	Down button	Press to decrease a value in the lower readout.
	Up button	Press to increase a value in lower readout.

Figure 1-2 Controller buttons and indicators



For Valve Positioning, please refer to Appendix D 'Motorised Valve Control

1.2 GETTING STARTED

Thank you for selecting the 2216e controller. This section shows the **principle** of operation.

1.2.1 Viewing The Process Value and Setpoint

Install and wire up the controller in accordance with Chapter 2 and switch on. Following a 3 second self-test sequence, this is the display you will see,

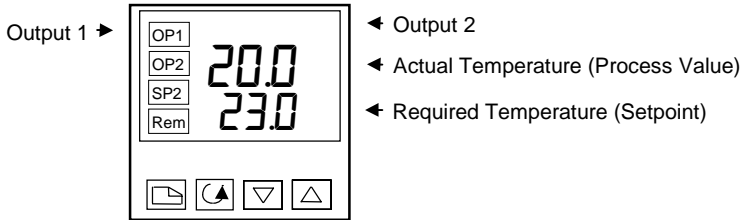

Figure 1-3 The “Home Display”



The display may flash an alarm message. Refer to the Parameter Tables later in this chapter for a complete list and meaning of the messages.

1.2.2 To Adjust The Setpoint

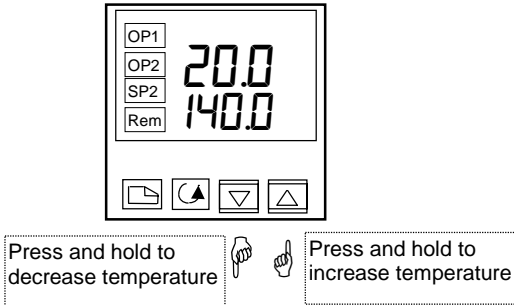

Figure 1-4 The lower readout shows the setpoint

After 2 seconds the lower readout will ‘blink’ indicating that the new value has been accepted. For everyday use you may not need to do anymore than this.

1.2.3 Viewing The Display Units

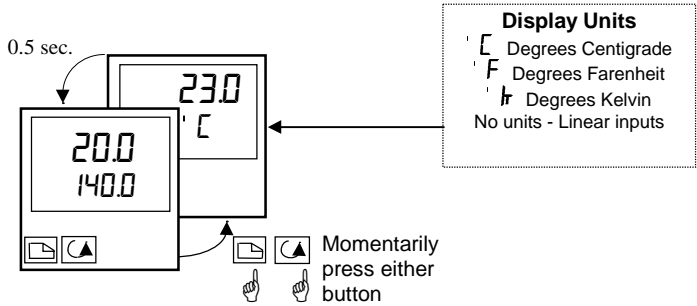

Figure 1.5 Pressing or will flash the display units for 0.5 secs



If you get lost, pressing and together will return you to the Home display

1.2.4 Use Of The “SCROLL” Button

Pressing the scroll button will display the output power level. Continued pressing will display further parameters in the operator scroll list.

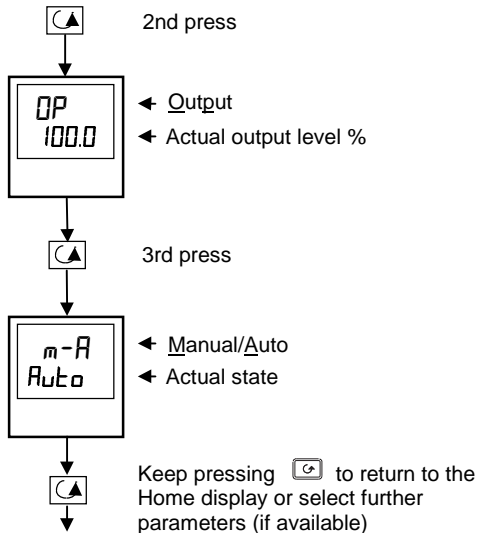

Figure 1-6 Upper readout is parameter name. Lower is value

1.2.5 Use Of The 'PAGE' Button

The "PAGE" button  accesses parameter LISTS.

Parameters are settings in the instrument which, generally, can be changed by the user to suit the process. Examples are: Alarms, Self Tune, etc. They are found under headings called **LISTS** and a full set is given later in this chapter.

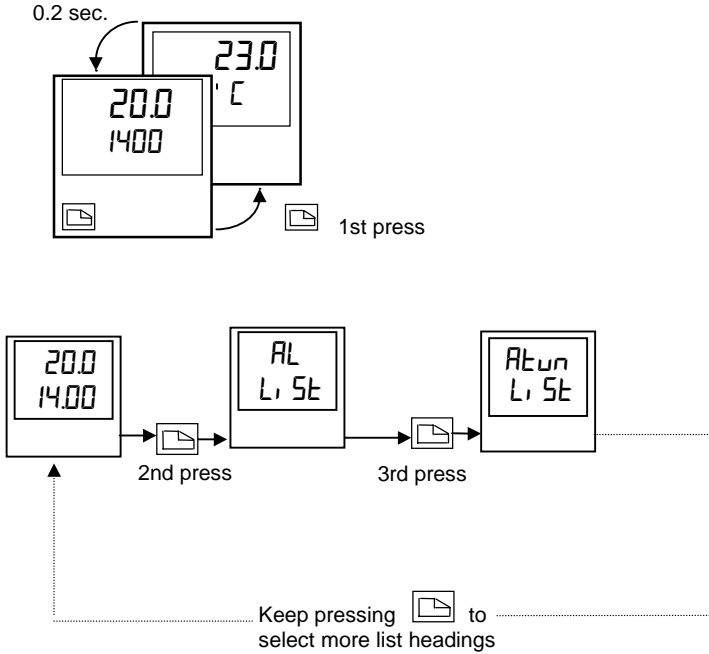

Figure 1-7 Press  to choose a parameter list



The actual list headings may be longer or shorter than indicated above and you can customise this for the operator's convenience in EDIT level, Chapter 3.

1.3 PARAMETER LISTS

Press to choose a LIST - “ALARMS” is a good one. This list allows you to set the alarm trip levels. The parameters which appear in the list will vary according to the configuration of your controller.

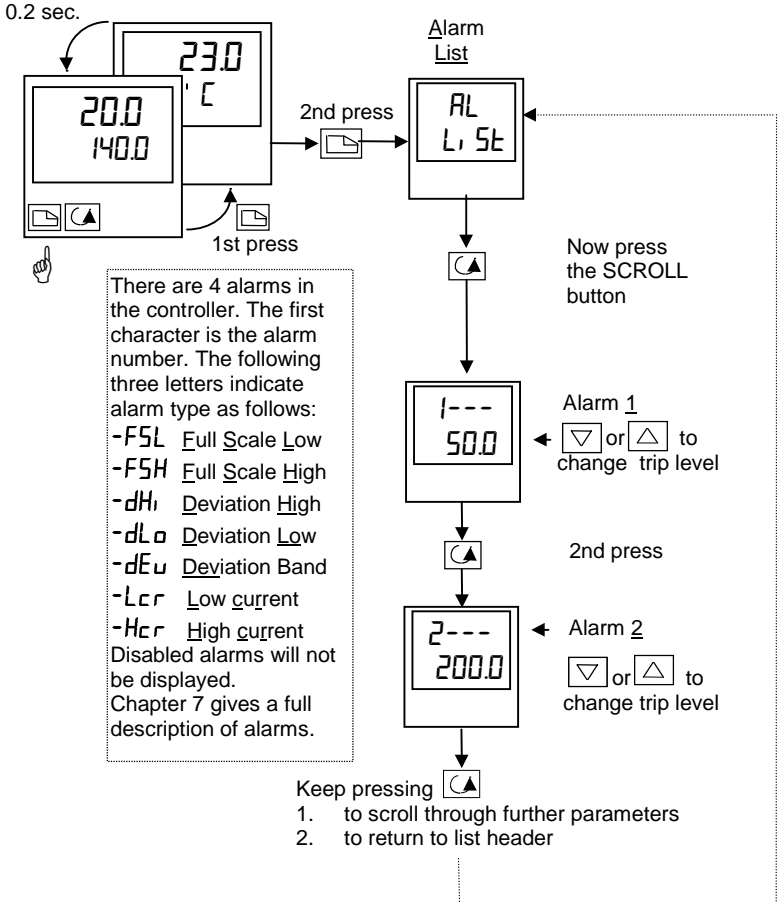

Figure 1-8 Choose a list. Press to select a parameter

If, at any time, no key is pressed within 45 seconds, the display will always return to the “HOME” display.

A complete description of the parameter lists is given on page 1-14.

1.4 MANUAL OR AUTOMATIC CONTROL

The controller can be used in two modes:

Automatic mode - in which the output power is automatically adjusted to hold the temperature at the required value. The controller normally operates in this mode.

Manual mode - in which the output is manually adjusted by the Operator. In this mode the 'MAN' light will be on.

One other mode is available:

Remote setpoint - The setpoint is generated as an input signal from a master 2000 series controller. In this mode the REM light is on.

1.4.1 Selecting Auto/Manual Operation

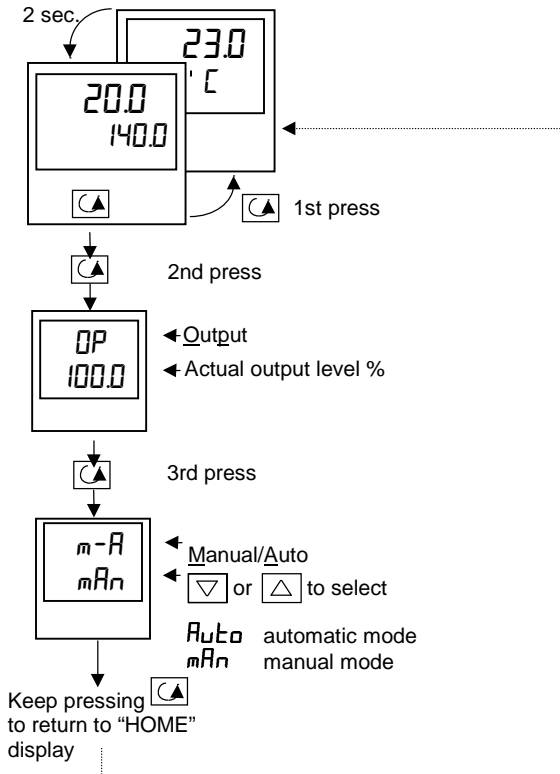

Figure 1-9 Auto/Manual select

1.4.2 How To Manually Adjust Output Power

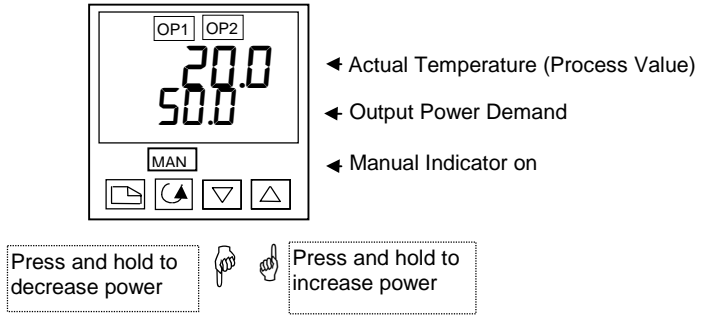



Figure 1-10 The “Home Display” in manual mode





Manual mode is generally used for test and commissioning purposes, take care not to leave the controller in this mode since damage or personal injury could occur.

1.5 SUMMARY

To step through list headers press the Page button  until the required header is obtained

To step through parameters within a particular list press the Scroll button  until the required parameter is obtained

To change the value (or state) of a parameter press the Raise button  or the Lower button 

The remainder of this chapter provides a complete list of all parameters available.

1.6 SETPOINT 1 OR SETPOINT 2

The instrument has the facility to select two setpoints. This may be useful where it is required to switch control between two different setpoints, for example, from an operating to a standby condition, thus avoiding the necessity to change the setpoint manually each time.

1.6.1 To Select Setpoint 1 or Setpoint 2

This may be done in two ways:-

1. By an external switch or relay contact wired to a digital input
2. Through the front panel using the *SP* list

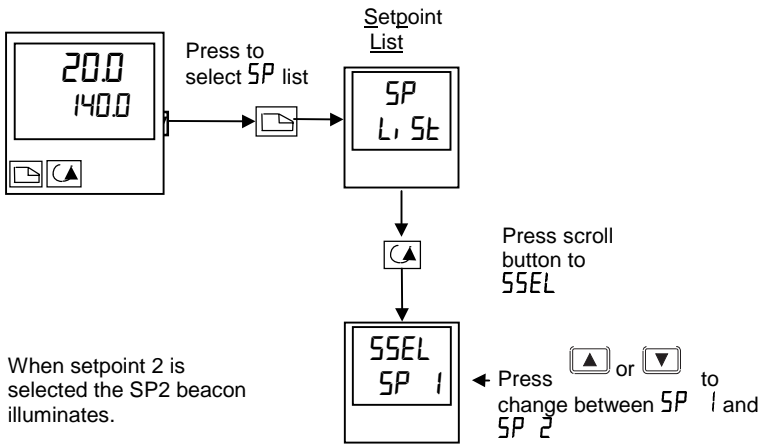

Figure 1-11 To Select Setpoint 1 or 2

1.7 RAMP DWELL FUNCTION

The ramp dwell function is selected by turning the setpoint rate limit parameter *SPrr* to a value. It can be set to RUN in two ways:-

1. Through the front panel using the *SP* list
2. By an external switch or relay contact wired to a digital input (Module 2 only) configured for reset (*rSEt*). When closed the program will reset. When open the program will run. To run the program from the initial reset state, it is necessary to first close the switch then open it.

The controller will then ramp from setpoint 1 to setpoint 2 at a rate set by the *SPrr* parameter.



When the controller reaches setpoint 2 it can remain at this level for a timed period, using the *dwEll* parameter.

At the end of the dwell period the action of the controller is determined by the End Type parameter *Endt*.

1.7.1 To Set up a Ramp/Time Program

Set setpoint 1 to the value at which to start the ramp. Set setpoint 2 to the value which you wish to ramp to. This is described in the previous section.



Now press  until *SPrr* is displayed

Press  or  to set the SP ramp rate in units per minute

SPrr
20.0

In Run mode the controller will ramp from SP 1 to SP 2 at 20.0 units per minute



Press scroll button to *dwEll*

Press  or  to set the dwell time in minutes

dwEll
60.0

In Run mode the controller will dwell at SP 2 for 60 minutes

Press scroll button to *Endt*

Press  or  to choose the action required at the end of the dwell time

Endt
rSEt



In Run mode the controller will reset at the end of the dwell time.
Other choices are:-

<i>HoLd</i>	The program will go into Hold
<i>StEbY</i>	The program will go into standby
<i>dwEll</i>	The program will dwell for an unlimited period

Figure 1-12 Ramp/Dwell Program

1.7.2 To Run the Program

From the previous view, press scroll button to *Prog*

Press  or  to choose *run*

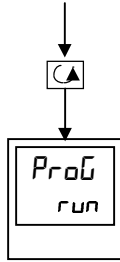

To reset the controller to start conditions, select *rSEt*

In Full access level the Status of the program can be read as follows:-

From the previous view, press scroll button to *SEt*

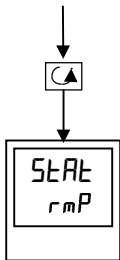

The status may be any one of the following:

<i>rmp</i>	Ramping from SP1 to SP2
<i>dwEll</i>	Dwelling at SP2
<i>End</i>	The program is complete. If <i>Endt = rSEt</i> , <i>End</i> will flash briefly before changing to <i>OFF</i>
<i>OFF</i>	The program is in the reset state

A program may also be reset or run using an external switch contact if a digital input, in Module 2, has been configured. See Configuration section.

Figure 1-13 To Run the Ramp/Dwell Program

1.7.3 Power Failure During Program Run

1. During Ramp. After return of power, the working setpoint will servo to the current PV value, and the ramp continues to SP2 followed by the timed dwell.
2. During Dwell. After return of power the working setpoint will servo to PV, the ramp continues to SP2 followed by full programmed dwell. In effect this causes the program to restart.



Use the Hide, Reveal and Promote features to customise the display for a programmer. See Chapter 3.

1.8 LOCATION OF PARAMETERS - BLOCK DIAGRAM

The controller consists of a number of internal function blocks connected together to create a temperature controller. Each function block has a number of parameters found in lists to which the user has access. The block diagram shows location of these parameters within the controller.

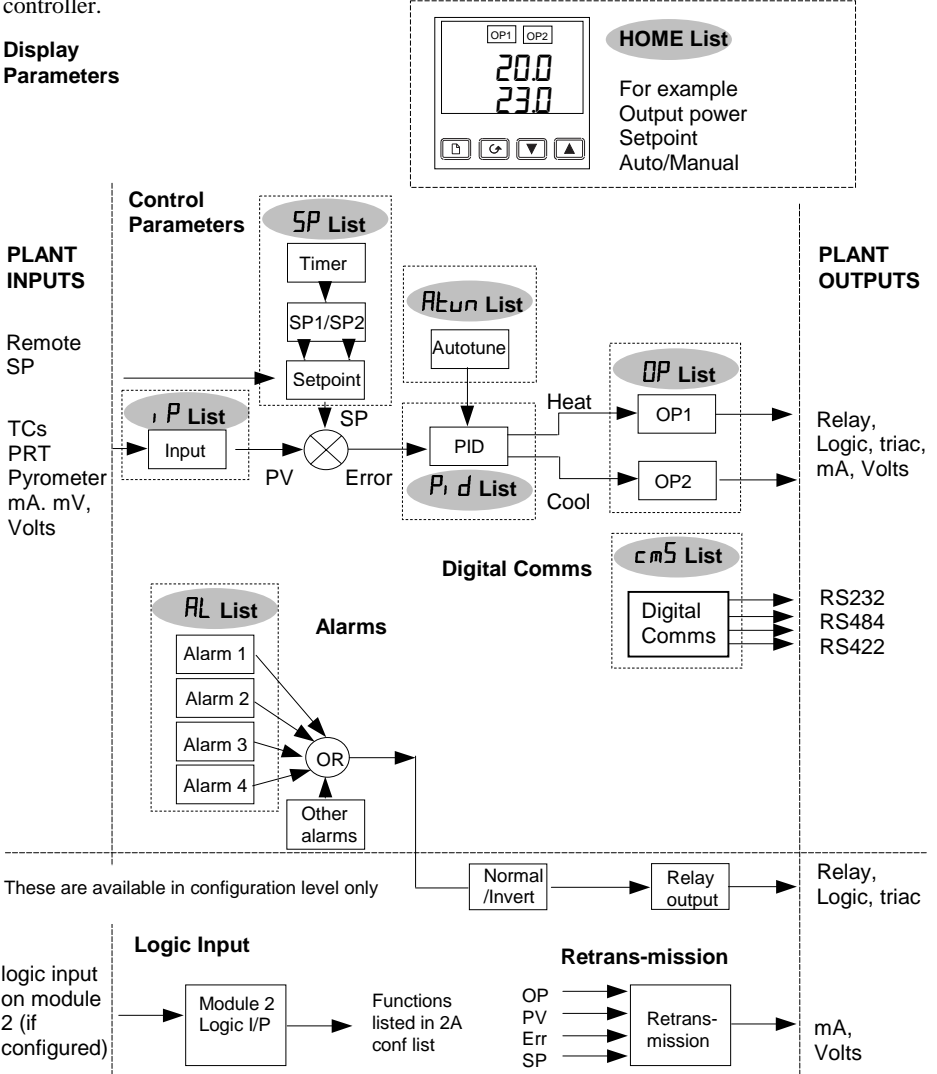
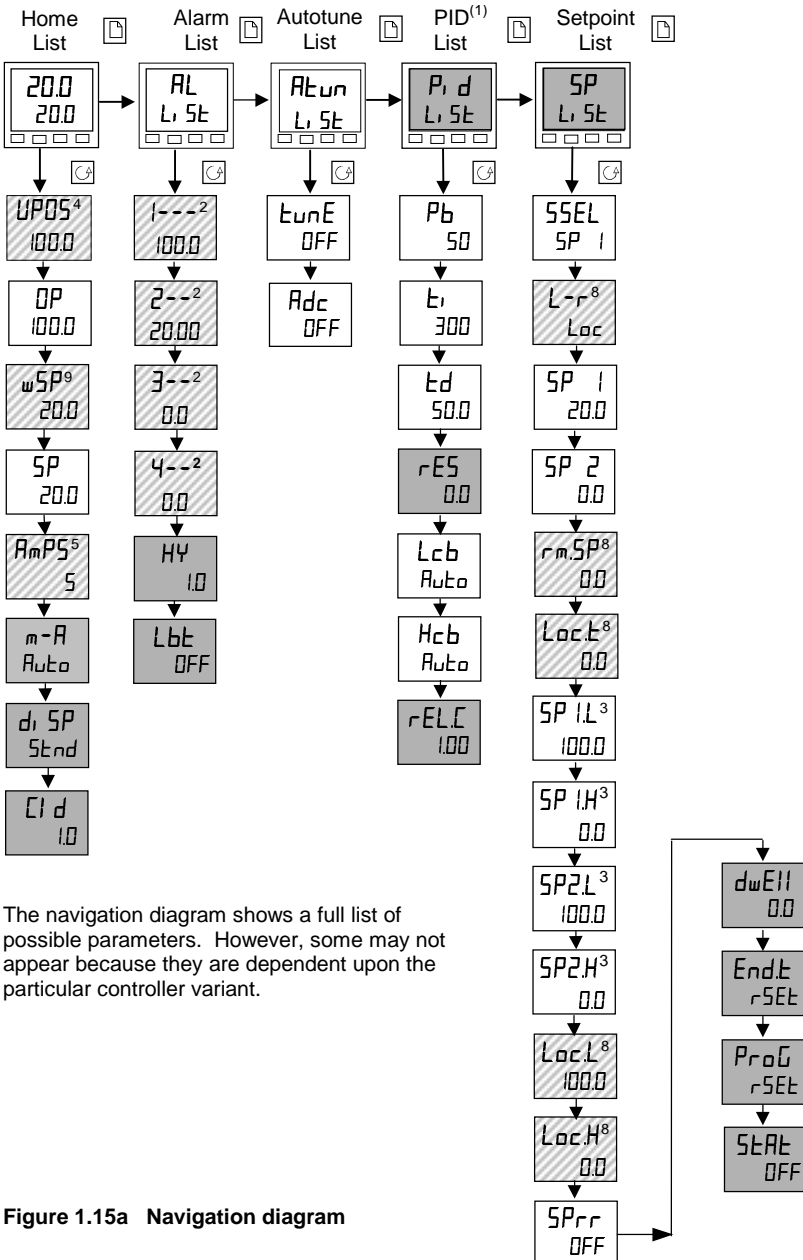

Figure 1-14 Controller Block Diagram

1.9 NAVIGATION DIAGRAM (PART A)



The navigation diagram shows a full list of possible parameters. However, some may not appear because they are dependent upon the particular controller variant.

Figure 1.15a Navigation diagram

NAVIGATION DIAGRAM (PART B)

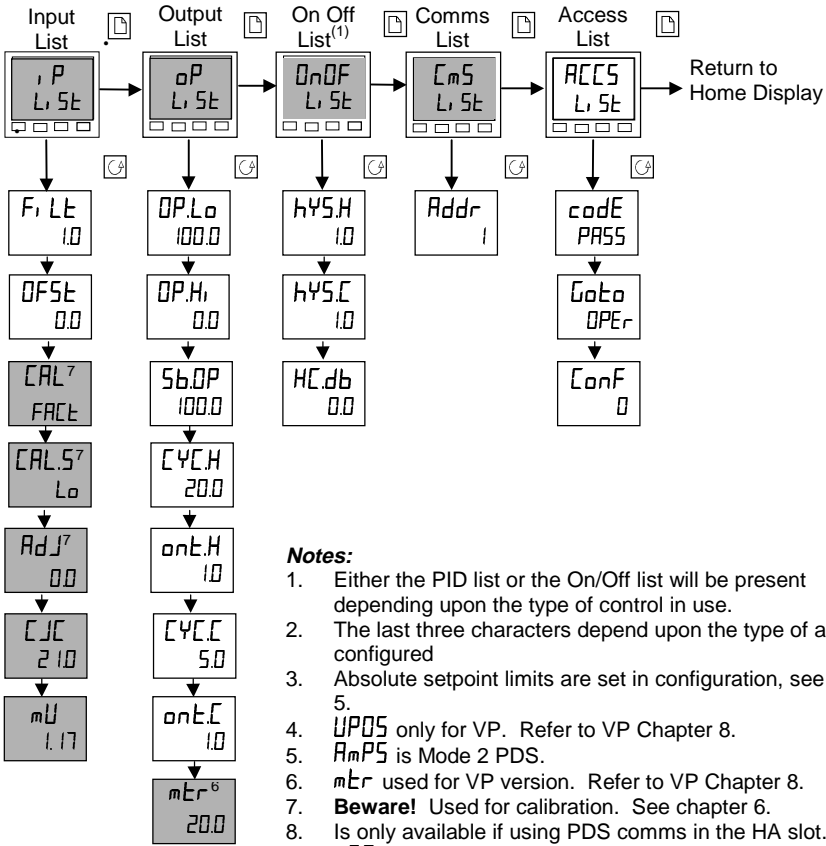

Notes:

1. Either the PID list or the On/Off list will be present depending upon the type of control in use.
2. The last three characters depend upon the type of alarm configured
3. Absolute setpoint limits are set in configuration, see Chapter 5.
4. *UPDS* only for VP. Refer to VP Chapter 8.
5. *AmPS* is Mode 2 PDS.
6. *mEr* used for VP version. Refer to VP Chapter 8.
7. **Beware!** Used for calibration. See chapter 6.
8. Is only available if using PDS comms in the HA slot.
9. *wSP* is available if using ramp to setpoint.

 Complete lists or individual parameters normally hidden in Operator level. To see all the available parameters you must select Full level. See Chapter 3, *Access Levels*

 Only displayed when option selected

Figure 1.15b Navigation diagram

1.10 PARAMETER TABLES

The tables which follow list all parameters that are available in Full operator level.

Name	Parameter Description	Default Value		Min Value	Max Value	Units	Customer Setting
		UK	USA				

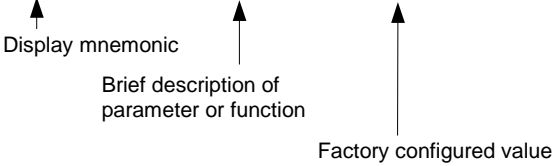

1.10.1 HOME Display

Name	Parameter Description	Default Value		Min Value	Max Value	Units	Customer Setting
		UK	USA				

Home List							
Home	Measured Value and Setpoint(SP)	SP=25° C	SP=75° F			as display	
μ PoS	Valve positioner output power			0.0	100.0	%of mtr	
OP	% Output Level			- 100.0	100.0	%	
wSP	Working setpoint					as display	
SP	Setpoint			-999	9999	as display	
AmPS	Heater current (PDS modes 2 and 5)			0	100	AmPS	
m-A	Auto/manual select	Auto	Auto				
di SP	Configure lower readout of home display	Std	Std				NonE Std' AmPS' OP' SEtE' μ PoS
Li d	Customer ID	0	0	0	9999		

Additional parameters may appear in the Home display if the 'promote' feature has been used (see *Edit Level*, Chapter 3).

1.10.2 Alarm List

Name	Parameter Description	Default Value		Min Value	Max Value	Units	Customer Setting
		UK	USA				
AL	Alarm List						
1---	Alarm 1 set point value	0	0			as display	
2---	Alarm 2 set point value	0	0			as display	
3---	Alarm 3 set point value	0	0			as display	
4---	Alarm 4 set point value	0	0			as display	
<i>In place of dashes, the last three characters indicate the alarm type, as follows:</i>							
-F5H	Full Scale High alarm			-999	9999	as display	
-F5L	Full Scale Low alarm			-999	9999	as display	
-dEu	Deviation band alarm			0	9999	as display	
-dHi	Deviation High alarm			0	9999	as display	
-dLo	Deviation Low alarm			0	9999	as display	
-Lcr	Low current alarm			0	100	Amps	
-Hcr	High current alarm			0	100	Amps	
HY	Hysteresis			0	9999	as display	
Lbt	Loop break time	OFF	OFF	0	9999	secs	

1.10.3 Autotune List

Aut	Autotune List						
tune	Self tune enable	OFF	OFF	OFF	On		
adc	Automatic droop compensation (Manual Reset) enable (only present if <u>Et</u> set to OFF)	mAn	mAn	mAn	CALL		

1.10.4 PID List

Name	Parameter Description	Default Value		Min Value	Max Value	Units	Customer Setting
		UK	USA				
<i>P_i d</i>	PID List						
<i>P_b</i>	<u>Proportional band</u>	20.0	30	1	9999	as display	
<i>t_i</i>	<u>Integral time</u>	360	360	OFF	9999	seconds	
<i>t_d</i>	<u>Derivative time</u>	60	60	OFF	9999	seconds	
<i>rES</i>	<u>Manual reset</u> (appears when <i>t_i</i> set to OFF)	0.0	0.0	0.00	100.0	%	
<i>Lcb</i>	<u>Cutback low</u>	Auto	Auto	0	9999	as display	
<i>Hcb</i>	<u>Cutback high</u>	Auto	Auto	0	9999	as display	
<i>rELC</i>	<u>Relative cool gain</u> (set 1)	1.00	1.00	0.01	9.99		

1.10.5 Setpoint List

Name	Parameter Description	Default Value		Min Value	Max Value	Units	Customer Setting
		UK	USA				
SP	Set Point List						
<i>SEEL</i>	Select <i>SP1</i> or <i>SP2</i>	<i>SP1</i>	<i>SP1</i>	<i>SP1</i>	<i>SP2</i>		
<i>L-r</i>	Local or remote setpoint select	<i>Loc</i>	<i>Loc</i>	<i>Loc</i>	<i>rmE</i>		
<i>SP1</i>	Setpoint 1 value	25	70	As display range			
<i>SP2</i>	Setpoint 2 value	25	70	As display range			
<i>rmSP</i>	Remote setpoint	0	0	As display range			
<i>LocE</i>	Local trim	0	0	As display range			
<i>SP1L</i>	Setpoint 1 low limit	0	32	As display range			
<i>SP1H</i>	Setpoint 1 high limit	1000	2100	As display range			
<i>SP2L</i>	Setpoint 2 low limit	0	32	As display range			
<i>SP2H</i>	Setpoint 2 high limit	1000	2100	As display range			
<i>LocL</i>	Local setpoint trim low limit	-210	-346	As display range			
<i>LocH</i>	Local setpoint trim high limit	1200	2192	As display range			
<i>SPrr</i>	Setpoint rate limit	OFF	OFF	As display range			
<i>dwE11</i>	Dwell time	OFF	OFF	0.1 to 999.9 minutes			
<i>EndE</i>	End type	<i>rES</i>	<i>rSEt</i>	<i>rSEt</i> <i>hold</i> <i>Stby</i> <i>dwE11</i>			
<i>Prog</i>	Program control	<i>rSEt</i>	<i>rSEt</i>	<i>run</i> <i>rSEt</i>			
<i>StARt</i>	Status of program		OFF	<i>rmP</i> <i>dwE11</i> <i>End</i> OFF			

1.10.6 Input List

Name	Parameter Description	Default Value		Min Value	Max Value	Units	Customer Setting
		UK	USA				
IP	Input list						
*F, LE	Input <u>filter</u> time constant	1.6	1.6	0.0 OFF	999.9	secs	
OFSE	PV Offset			-999	9999	as display	
The next 5 parameters will appear if User calibration has been enabled in configuration level. To perform a user calibration refer to Ch 6.							
CAL	FACT will re-instate factory settings and disable User Calibration. Default setting FACT USER will re-instate any previously set User Calibration offsets and make available User Calibration parameters as follows:						
CALS	User calibration select	nonE	nonE				Hi, Lo, nonE
Adj~	Adjust calibrated reference source						
The following two parameters are always present in Full Access level but not in Operator level							
CJC°	Cold Junction compensation temperature						
mV	Millivolt input						

* A minimum filter time constant of one second is recommended to provide sufficient noise immunity.

~ Do not make adjustments to the **Adj** parameter unless you wish to offset the controller calibration.

1.10.7 On/Off List

OnOff	On/off list						
This set of parameters only appear if On/Off control has been configured							
hYS.H	Heat <u>h</u> ysteresis	0	0	0	9999	as display	
hYS.C	Cool <u>h</u> ysteresis	0	0	0	9999	as display	
HC.db	Heat/Cool <u>d</u> ead <u>b</u> and	1	1	0	9999	as display	

1.10.8 Output List

Name	Parameter Description	Default Value		Min Value	Max Value	Units	Customer Setting
		UK	USA				

<i>oP</i>	<u>Output list</u>	Note: If On/Off control is configured only <i>5bOP</i> , <i>onEH</i> and <i>onEL</i> will appear in the following list					
<i>OP.Lo</i>	Low (power) output limit	0.0 or -100.0 (cool)		-100.0	100.0	%	
<i>OP.Hi</i>	High (power) output limit	100.0	100.0	-100.0	100.0	%	
<i>5bOP</i>	Output setting when in sensor break	0.0		-100.0	100.0	%	
<i>1CYCH</i>	Heat cycle time	1.0 (logic) 20 (relay)		0.2	999.9	secs	
<i>onEH</i>	Heat output min. on time	0.1	0.1	Auto (50mS)	999.9		
<i>1CYCL</i>	Cool cycle time	1.0 (logic) 20 (relay)		0.2	999.9	secs	
<i>1onEL</i>	Cool output min. on time	0.1	0.1	Auto (50mS)	999.9	secs	
<i>mTr</i>	VP motor travel time			0.0	999.9	secs	

¹ Are not used for Valve Position Control.

1.10.9 Communications List

<i>cmS</i>	<u>Comms list</u>						
<i>Addr</i>	Communications address	1	1	1	254		

1.10.10 Access List

<i>ACCs</i>	<u>Access list</u>						
<i>codE</i>	Full and Edit level password	1	1	0	9999		
<i>Goto</i>	Goto level 'OPER', Full Edit' or conf	OPER	OPER	OPER	conf		
<i>CONF</i>	Configuration level password	2	2	0	9999		

1.11 ALARMS

Alarms are used to alert an operator when a pre-set level has been exceeded. They are normally used to switch an output (see 1.12) – usually a relay – to provide external actions to the process.

Soft Alarms are indication only and do not operate an output.

Events are generally defined as conditions, which occur as part of the operation of the plant. They do not require operator intervention and, therefore, do not cause an alarm message to be displayed. They can be attached to operate an output (relay) in the same way as an alarm.

1.11.1 Types of Alarm Used in the 2200

This section shows graphically the operation of different types of alarm used in the controller. The graphs show changes in PV plotted against time.

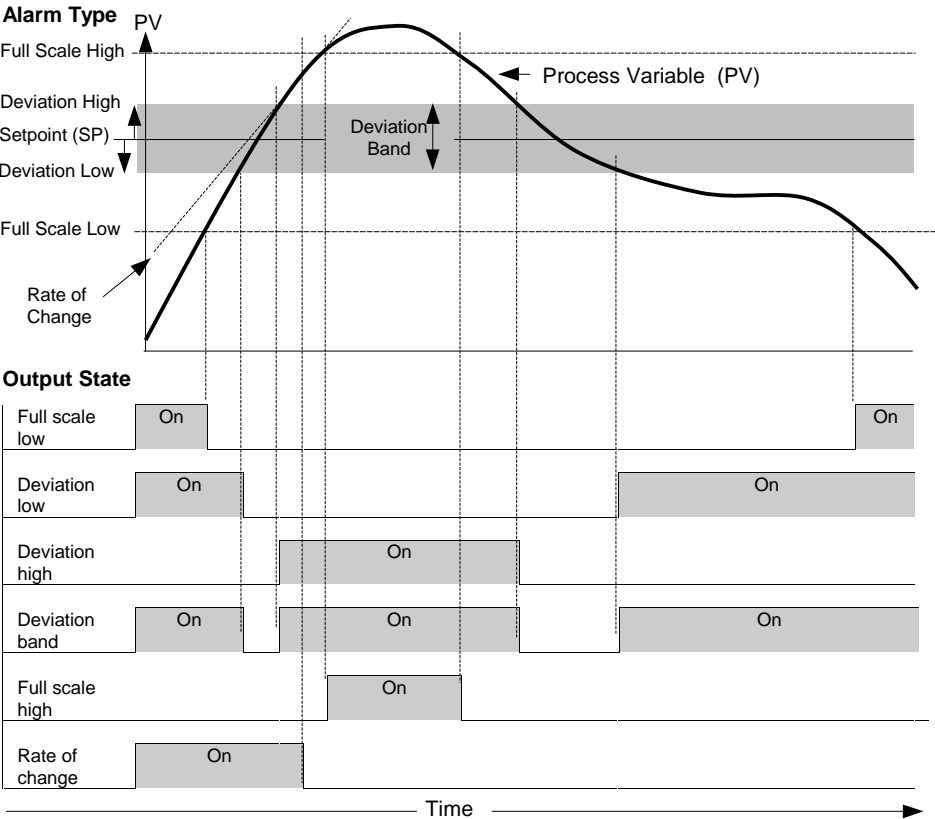

Figure 1-16: Alarm Types

Hysteresis is the difference between the point at which the alarm switches ON and the point at which it switches OFF.

It is used to prevent relay chatter.

Blocking Alarms only occur after the start up phase when the alarm has first entered a safe state. The alarm is only indicated the next time it is active. It is used, for example, to ignore start up conditions which are not representative of running conditions.

Latching Alarms see 7.1.1.

Delay a settable time between an alarm occurring and it being displayed on the indicator

Loop Break Alarm. The control loop is considered to be open if the output demand signal increases to saturation level but the error does not reduce after a set period of time. The time period can be set manually, depending on the response time of the loop, using the parameter **Lbt** in the Alarm List (section 1.10.2). It is, also set automatically, following an autotune (see chapter 4), to $3 \times t_i$ (integral time). The time period, **Lbt**, starts from the point at which the output demand reaches saturation. The loop break alarm **Lbr** is displayed (as a diagnostic alarm, see section 1.12.3.) at the end of this period.

1.12 ALARM RELAY OUTPUT



Alarms can operate a specific output (usually a relay). Any individual alarm can operate an individual relay or any combination of alarms can operate an individual relay. They are either supplied pre-configured in accordance with the ordering code or set up in configuration level.

See Chapter 5 for further information.

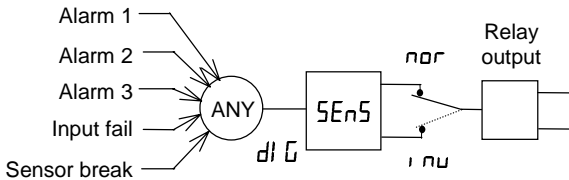

Any combination of alarms can operate the relay. Typical alarms are shown

Figure 1-17: Attaching Alarms to an Output

1.12.1 SETTING ALARM LEVELS

Up to 4 Alarms may be configured. Each alarm is given a name to describe its function - see table below:

If an alarm is not configured it does not appear in the list below.

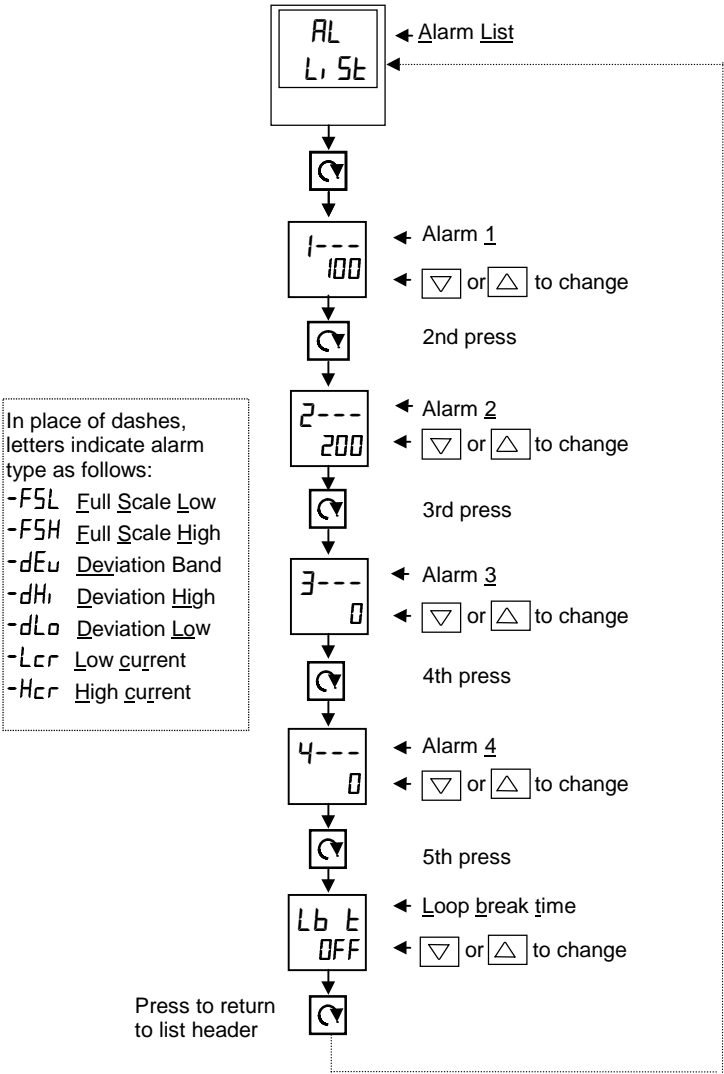



Figure 1-18 To Set Alarm Trip Levels

1.12.2 ALARM INDICATION AND ACKNOWLEDGEMENT

When an alarm occurs, the alarm mnemonic (e.g. *IFSH*) will be indicated by a double flash in the HOME display. Similarly, if more than one alarm occurs the relevant mnemonics are flashed in the HOME display. The double flash will continue whilst the alarm condition is present and is not acknowledged.

Press  and  together to acknowledge the alarm.

If the alarm condition is still present when the alarm is acknowledged, it will be indicated by a single flash of the alarm mnemonic and this single flash will be repeated for as long as the alarm condition remains. When the alarm condition disappears the indication will also disappear.

If the alarm condition is no longer present when the alarm is acknowledged, the flashing message will disappear immediately on acknowledgement.

If a relay has been attached to the alarm output (see Chapter 7 'Alarm Operation'), it will operate when the alarm condition occurs and remain in the operated condition until the alarm is acknowledged AND it is no longer present

1.12.3 DIAGNOSTIC ALARMS

These indicate that a fault exists in either the controller or the connected devices.

Display shows	What it means	What to do about it
EEEr	<i>Electrically Erasable Memory Error:</i> The value of an operator or configuration parameter has been corrupted	This fault will automatically take you into configuration level. Check all of the configuration parameters before returning to operator level. Once in operator level, check all of the operator parameters before resuming normal operation. If the fault persists or occurs frequently, contact your supplier
S.br	<i>Sensor Break:</i> Input sensor is unreliable or the input signal is out of range	Check that the sensor is correctly connected
L.br	<i>Loop Break:</i> The feedback loop is open circuit	Check that the heating and cooling circuits are working properly
LdF	<i>Load failure</i> Indication that there is a fault in the heating circuit or the solid state relay	This is an alarm generated by feedback from a TE10S solid state relay (SSR) operating in PDS SSRx Load Doctor-see <i>Electrical installation</i> Chapter 2. It indicates either an open or short circuit SSR, blown fuse, missing supply or open circuit heater
SSrF	<i>Solid state relay failure</i> Indication that there is a fault in the solid state relay	This is an alarm generated by feedback from a TE10S solid state relay (SSR) operating in PDS SSRx Load Doctor see <i>Electrical installation</i> Chapter 2. It indicates either an open or short circuit condition in the SSR
Ht.F	<i>Heater failure</i> Indication that there is a fault in heating circuit	This is an alarm generated by feedback from a TE10S solid state relay (SSR) operating in PDS SSRx Enhanced Load Doctor-see <i>Electrical installation</i> Chapter 2. It indicates either a blown fuse, missing supply or open circuit heater
HwEr	<i>Hardware error</i> Indication that a module is the wrong type	Check that the correct modules are fitted
n.o. i.o	<i>No I/O module</i> Modules are configured but not fitted	This error message normally occurs when pre-configuring a controller without installing any of the required I/O modules

Figure 1.19a Diagnostic alarms - continued on the next page

Diagnostic alarms continued

These indicate that a fault exists in either the controller or the connected devices.

Display shows	What it means	What to do about it
<i>r m t F</i>	<i>Remote input failure.</i> The PDS input is open circuit. (PDS Also known as SST – Smart Setpoint Transmission)	Check for open or short circuit wiring on the PDS input
<i>LLLL</i>	<i>Out of Display range, low reading</i>	Check the value of the display range
<i>HHHH</i>	<i>Out of Display range, high reading</i>	Check the value of the display range
<i>Err 1</i>	<i>Error 1: ROM self-test fail</i>	Return the controller for repair
<i>Err 2</i>	<i>Error 2: RAM self-test fail</i>	Return the controller for repair
<i>Err 3</i>	<i>Error 3: Watchdog fail</i>	Return the controller for repair
<i>Err 4</i>	<i>Error 4: Keyboard failure</i> Stuck button, or a button was pressed during power up.	Switch the power off and then on without touching any of the controller buttons.
<i>Err 5</i>	<i>Error 5: Input circuit failure</i>	Return the controller for repair*
<i>Pwr F</i>	<i>Power failure.</i> The line voltage is too low	Check that the supply to the controller is within the rated limits
<i>t U Er</i>	Tune error. If any one stage of the tuning process exceeds 2 hours the tune error alarm occurs	Check response time of process: check that the sensor has not failed: check that the loop is not broken. Acknowledge by pressing 'page' button and 'scroll' button together.

Figure 1.19b Diagnostic alarms

*If the user has disassembled and reassembled the instrument, this error can occur if any connectors are not seated properly.

Chapter 2 INSTALLATION

2.1 INSTRUMENT LAYOUT	2
2.1.1 Outline dimensions Model 2216e	3
2.2 INTRODUCTION	4
2.2.1 Controller labels	4
2.3 MECHANICAL INSTALLATION	4
2.3.1 Unplugging and plugging-in the controller	4
2.4 WIRING	5
2.4.1 Wire Sizes	5
2.4.2 Wiring connections	5
2.4.3 Sensor input connections	6
2.4.4 Outputs 1 and 2 connections.....	6
2.5 PDS MODES	7
2.6 SNUBBERS.....	7
2.7 TYPICAL SINGLE LOOP WIRING DIAGRAM.....	8
2.8 COMMUNICATION CONNECTIONS	9
2.8.1 Wiring of EIA-485 serial communication links.....	10
2.9 DEVICENET WIRING TO SERIES 2200E CONTROLLERS	11
2.9.1 DeviceNet Terminal Functions	11
2.9.2 Wiring Interconnections for DeviceNet Communications.....	12

2.1 INSTRUMENT LAYOUT

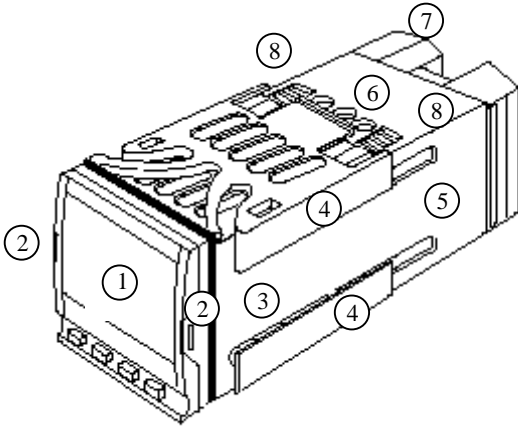

KEY

1. Display screen
2. Latching ears
3. Panel sealing gasket
4. Panel retaining clips
5. Label
6. Sleeve
7. Terminal covers
8. Ratchets

Figure 2-1: 2216e 1/16 DIN controller

2.1.1 Outline Dimensions Model 2216e

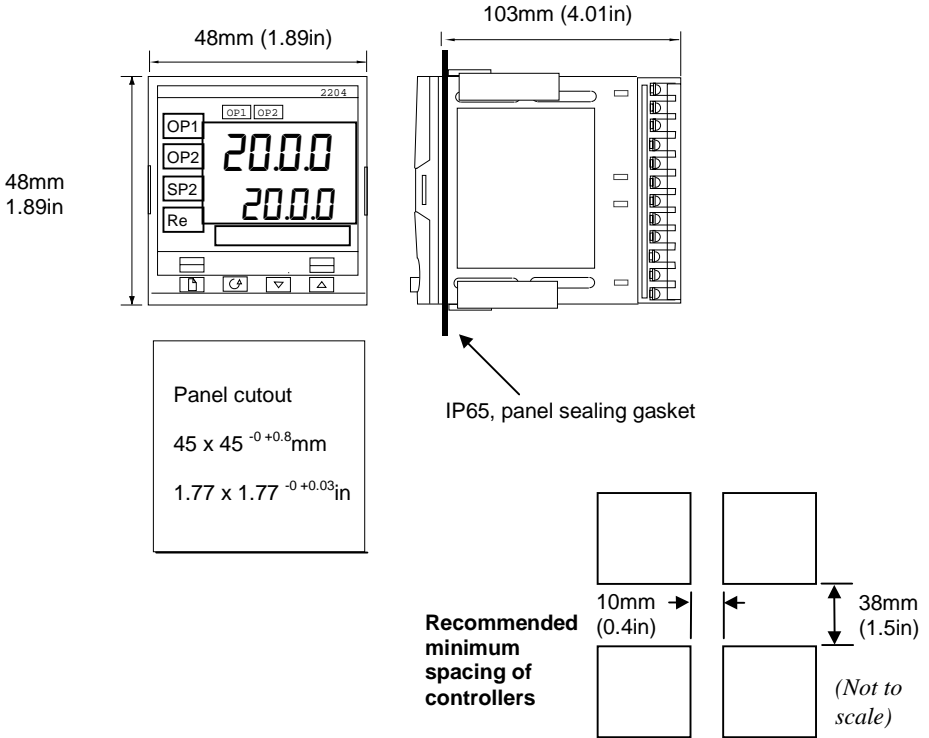

Figure 2-2: Outline dimensions Model 2216e controller

The controller plugs into a plastic sleeve, which in turn fits into the panel cutout shown above.

2.2 INTRODUCTION

The Model 2216e is a precision temperature controller with self tuning. It has a modular hardware construction which provides two control outputs, one alarm relay and one communications port.

2.2.1 Controller Labels

The labels on the sides of the controller identify the ordering code, the serial number, and the wiring connections.

Appendix A, *Understanding the Ordering Code* explains the hardware and software configuration of your particular controller.

2.3 MECHANICAL INSTALLATION

To install the controller

1. Cut the panel to the relevant hole size shown in Figure 2-2.
2. Insert the controller through the front of this cutout.
3. Spring the upper and lower panel retaining clips into place. Secure the controller in position by holding it level and pushing both retaining clips forward.



If the panel retaining clips subsequently need removing, they can be unhooked from the side with either your fingers or a screwdriver

2.3.1 Unplugging and Plugging-in the Controller

The controller can be unplugged from its sleeve by easing the latching ears outwards and pulling it forward out of the sleeve. When plugging the controller back into its sleeve, ensure that the latching ears click into place to maintain moisture sealing protection.

2.4 WIRING

Please read Appendix B, Safety and EMC information before proceeding.

WARNING



Please ensure that the controller is correctly configured for your application. Incorrect configuration could result in damage to the process being controlled, and/or personal injury. The controller may either have been configured when ordered, or may need configuring now. See Chapter 5, *Configuration*.

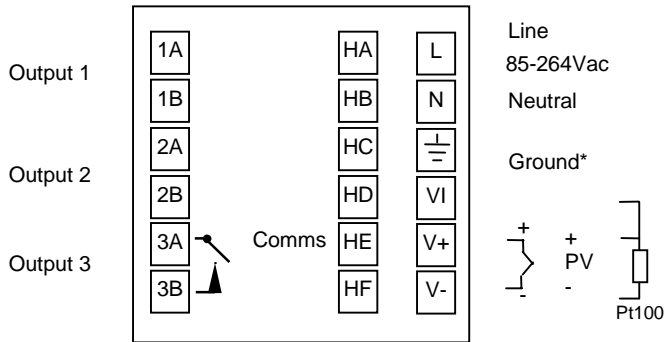

Figure 2-3: Model 2216e Wiring Connections



* The ground connection is not required for electrical safety but must be connected to satisfy EMC requirements.

2.4.1 Wire Sizes

All electrical connections are made to the screw terminals at the rear of the controller. They accept wire sizes from 0.5 to 1.5 mm² (16 to 22 AWG), and are protected by a hinged cover to prevent hands or metal making accidental contact with live wires. Rear terminals should be tightened to a torque of 0.4Nm (3.5 lb in).

2.4.2 Wiring Connections

The wiring connections are shown in Figure 2-3.

Outputs 1 and 2 are factory fitted modules which can be any one of the types shown in figure 2-5. Check the ordering code on the controller side label to determine which have been fitted.

2.4.3 Sensor Input Connections

The connections for the various types of input are as follows:

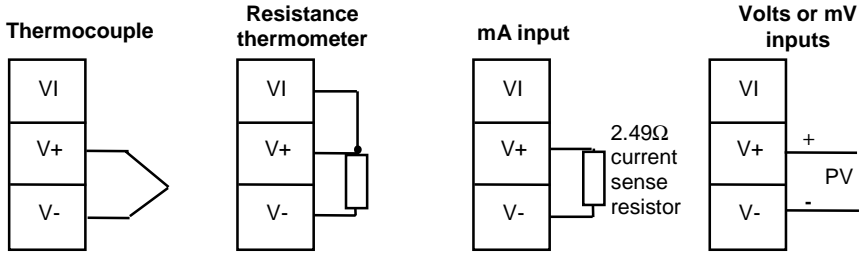

Figure 2-4: Sensor Input Connections



Sensor inputs should not be paralleled.

2.4.4 Outputs 1 and 2 Connections

Outputs 1 and 2 can be any one of the types shown in the table below, configured to perform any one of the functions shown.

To check which outputs are installed, and their configuration, refer to the ordering code and the wiring information on the controller side labels.

Module type	Connections				Possible functions
	Output 1		Output 2		
	1A	1B	2A	2B	
Relay: 2-pin (2A, 264 Vac max.)					Heating Cooling Alarms
Logic: non-isolated* (18Vdc at 24mA)					+PDS modes 1or 2 (SSRx Load Doctor Functions) Heating Cooling Alarms
Triac (1A, 30 to 264Vac)					Heating or cooling
DC control: isolated (18Vdc, 20mA max)			DC not available in output 2		PID Heating or cooling

*Logic can also be configured as logic input on module 2A.

+PDS Mode 1 & 2 are only supported in Output 1.

Figure 2-5: Outputs 1 and 2 connections

2.5 PDS MODES

PDS is a proprietary technique developed for bi-directional communication over a single pair of wires. There are several operating modes.

In **SSRx Load Doctor** a logic output delivers a power demand signal to a TE10S solid state relay (SSR) and the SSR responds with a single load circuit failure message.

In **SSRx Enhanced Load Doctor** a logic output delivers a power demand signal to an SSR and the SSR responds with the ON state RMS load current, and two fault messages - SSR failure or heater circuit failure.

2.6 SNUBBERS

The controller is supplied with 'snubbers' ($15\text{nF} + 100\Omega$) which should be wired across the relay or triac outputs when switching inductive loads such as mechanical contactors and solenoid valves. The snubbers are used to prolong contact life and to suppress interference when switching such loads.

Snubbers pass 0.6mA at 110Vac and 1.2mA at 240Vac , which may be sufficient to hold in high impedance relay coils. They should not, therefore, be used in such installations.

WARNING



When a relay contact is used in an alarm circuit ensure that the current passing through the snubber when the relay contact is open does not hold in low power electrical loads and thereby interfere with the failsafe operation of the alarm circuit.

2.7 TYPICAL SINGLE LOOP WIRING DIAGRAM

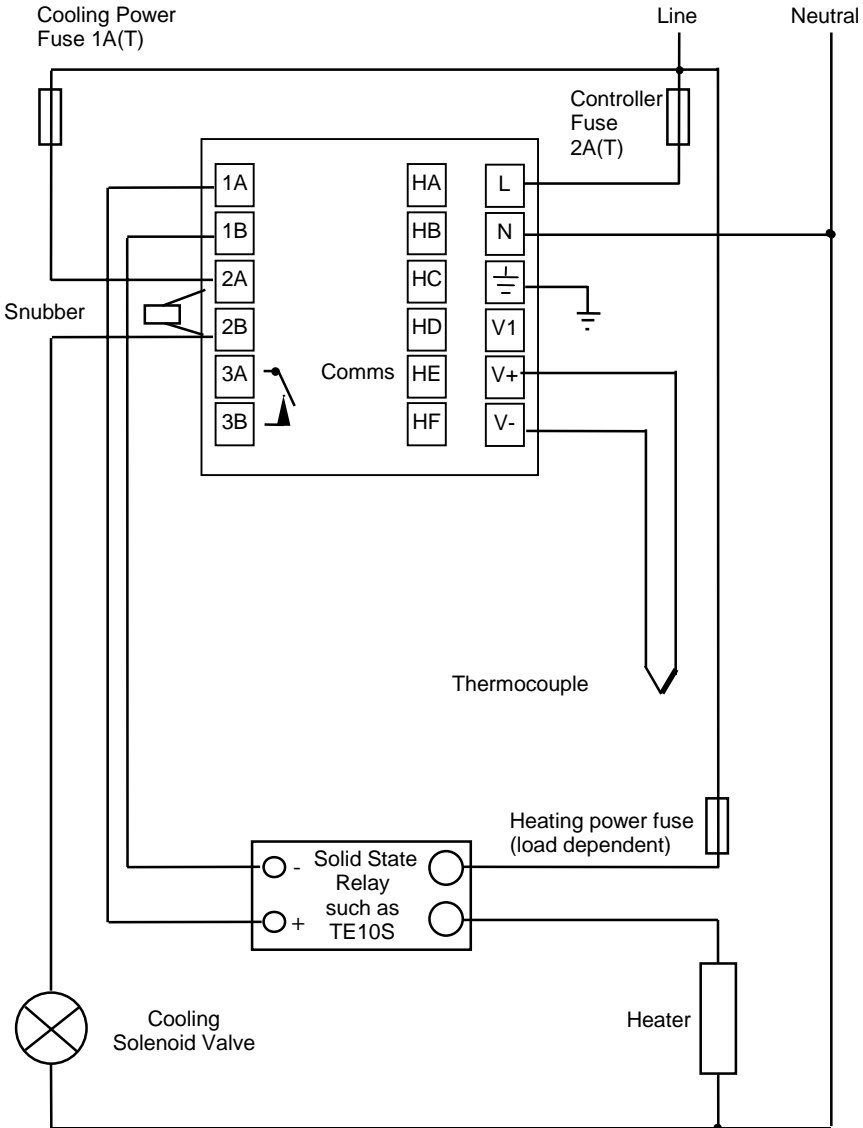

Figure 2-6: Typical wiring diagram, Model 2216e Controller

2.8 COMMUNICATION CONNECTIONS

The communication option can be either of four types shown in the table below

Communications type	Connection				
	HB	HC	HD	HE	HF
4-wire EIA-422 serial communications*	A' (RX +)	B' (RX -)	Common	A (TX +)	B (TX -)
EIA-232 serial communications	Not used	Not used	Common	A	B
PDS Setpoint input (SST)	Not used	Not used	Not used	Signal	Common
2-wire EIA-485 Serial Communications	Not used	Not used	Common	A (+)	B (-)

Figure 2-7: Communication connections

*The 4-wire EIA-422 communication board can be modified to support 2-wire 485 communication. Please consult factory.

2.8.1 Wiring of EIA-485 Serial Communication Links

Standard EIA-485 is a 2-wire connection which allows up to 32 controllers to be multi-dropped from a single communications link over a distance of up to 1.2Km. To ensure reliable operation of the communications link, (without data corruption due to noise or line reflections) the connections between the controller should be made using a twisted pair of wires inside a shielded cable with the connections terminated with resistors in the manner shown in this diagram. This diagram also shows the use of a converter to connect the 2-wire EIA-485 link into a standard EIA-232 computer port.

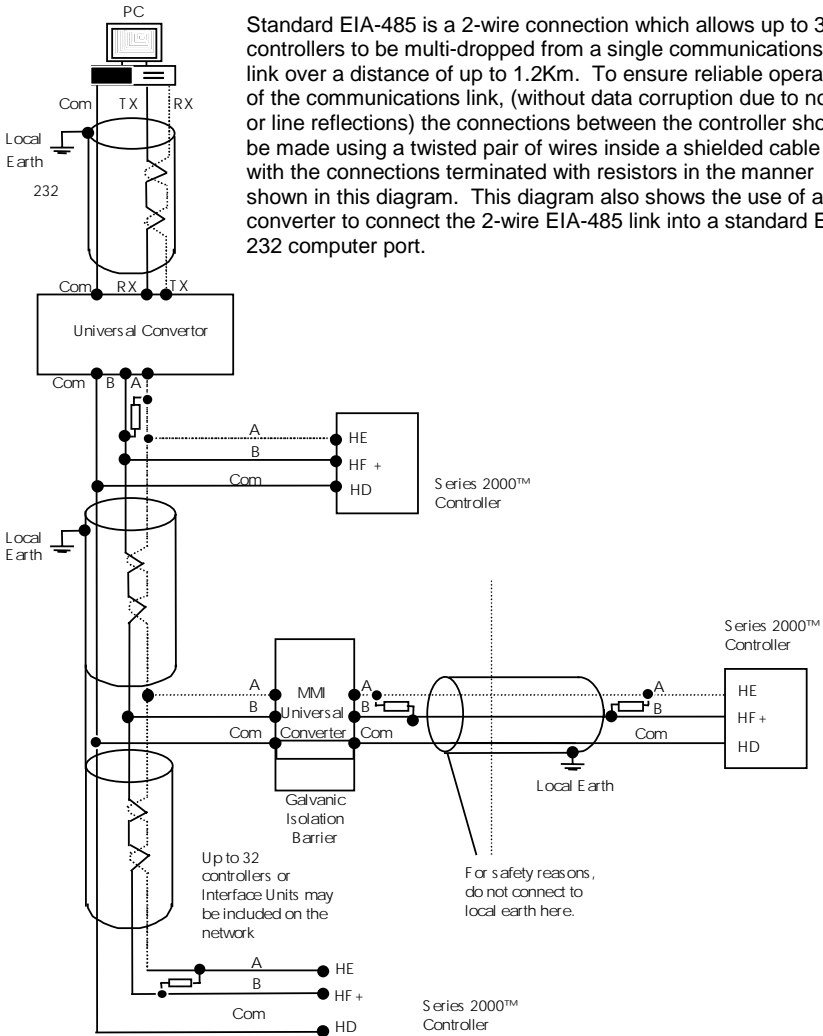

Note:
 All termination resistors are 220 ohm 1/4W carbon composition.
 Local grounds are at equipotential. Where equipotential is not available wire into separate zones using a galvanic isolator.

Figure 2-8: 2-wire EIA-485 wiring

2.9 DEVICENET WIRING TO SERIES 2200E CONTROLLERS

This section covers the DeviceNet digital communications option for the model 2216e PID controller. To configure DeviceNet communications refer to section 5.9.

2.9.1 DeviceNet Terminal Functions

Series 2200e Terminal	CAN Label	Color Chip	Description
HA	V+	Red	DeviceNet network power positive terminal. Connect the red wire of the DeviceNet cable here. If the DeviceNet network does not supply the power, connect to the positive terminal of an external 11-25 Vdc power supply.
HB	CAN_H	White	DeviceNet CAN_H data bus terminal. Connect the white wire of the DeviceNet cable here.
HC	SHIELD	None	Shield/Drain wire connection. Connect the DeviceNet cable shield here. To prevent ground loops, the DeviceNet network should be grounded in only one location.
HD	CAN_L	Blue	DeviceNet CAN_L data bus terminal. Connect the blue wire of the DeviceNet cable here.
HE	V-	Black	DeviceNet network power negative terminal. Connect the black wire of the DeviceNet cable here. If the DeviceNet network does not supply the power, connect to the negative terminal of an external 11-25 Vdc power supply.

Note: Power taps are recommended to connect the DC power supply to the DeviceNet trunk line. Power taps include:



A Schottky Diode to connect the power supply V+ and allows for multiple power supplies to be connected.

2 fuses or circuit breakers to protect the bus from excessive current which could damage the cable and connectors.

2.9.2 Wiring Interconnections for DeviceNet Communications

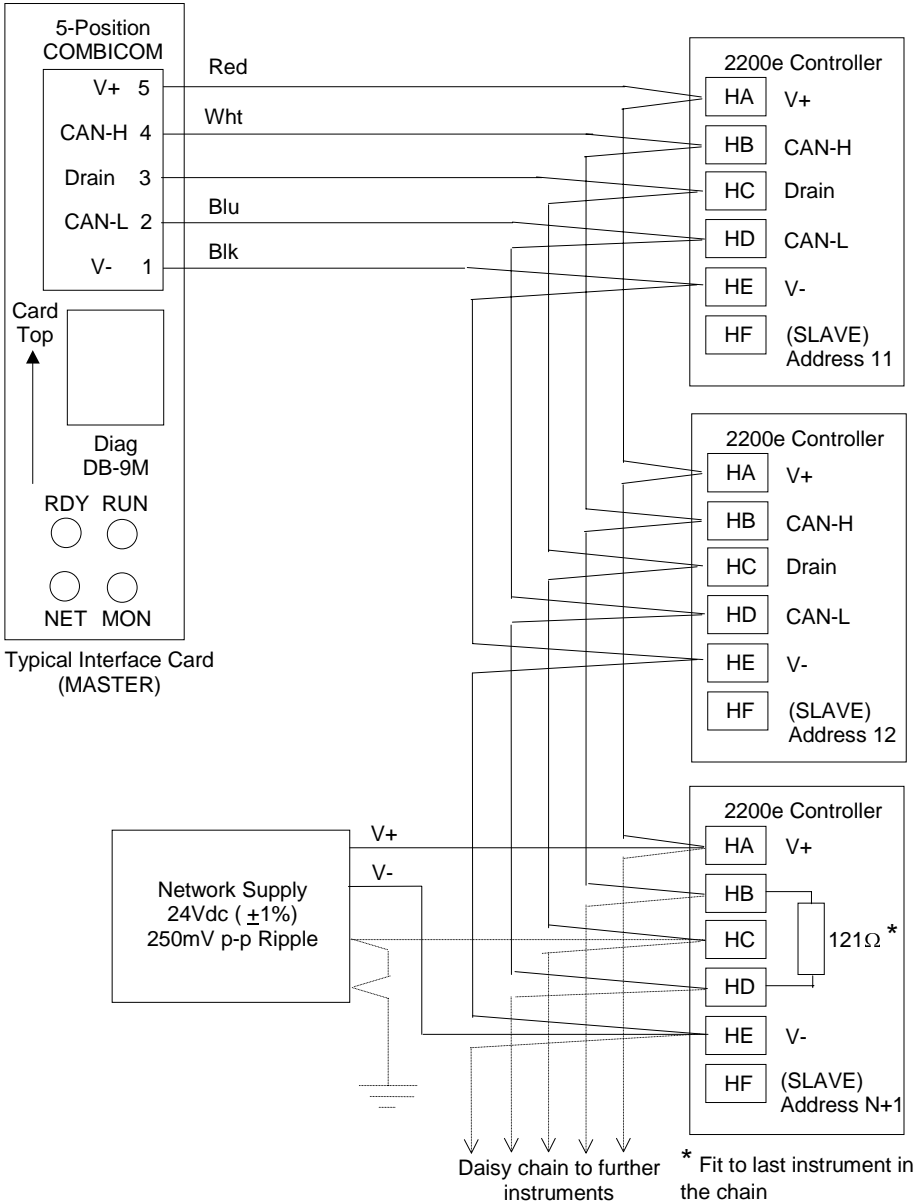

Figure 2-9: Wiring Connections for 2200e Series DeviceNet Controllers

Chapter 3 ACCESS LEVELS

- 3.1 THE DIFFERENT ACCESS LEVELS 2**
- 3.2 SELECTING AN ACCESS LEVEL..... 3**
 - 3.1.1 Returning to Operator Level..... 5
- 3.3 EDIT LEVEL 5**
 - 3.1.2 Setting operator access to a parameter 5
 - 3.1.3 Hiding or revealing a complete list 6
 - 3.1.4 Promoting a parameter 6

3.1 THE DIFFERENT ACCESS LEVELS

Access level	Display shows	What you can do	Password Protection
Operator	<i>OPER</i>	In this level operators can view and adjust the value of parameters defined in Edit level (see below).	No
Full	<i>FULL</i>	In this level all the parameters relevant to a particular configuration are visible. All alterable parameters may be adjusted.	Yes
Edit	<i>EDIT</i>	In this level you can set which parameters an operator in Operator level is able to view and adjust. You can hide or reveal complete lists and individual parameters within each list, and you can make parameters read-only or alterable. You can also promote parameters to the home list. (See <i>Edit level</i> at the end of the chapter).	Yes
Configuration	<i>CONF</i>	This special level allows access to set up the fundamental characteristics of the controller.	Yes

Figure 3-1 Access levels

3.2 SELECTING AN ACCESS LEVEL

Access to Full, Edit or Configuration levels is protected by a password to prevent unauthorised access.

If you need to change the password, see Chapter 5, *Configuration*

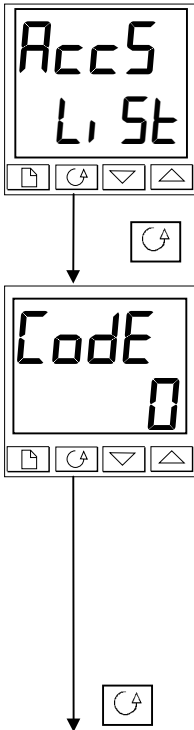



3.1.1 Access list header

Press  until you reach the access list header 'ACCESS'.

Press the Scroll button

3.1.2 Password entry

The password is entered from the 'CODE' display.

Enter the password using the  or  buttons. Once



the correct password has been entered, there is a two second delay after which the lower readout will change to show 'PASS' indicating that access is now unlocked.

The pass number is set to '1' when the controller is shipped from the factory.

Note; A special case exists if the password has been set to '0'. In this case access will be permanently unlocked and the lower readout will always show 'PASS'.

Press the Scroll button to proceed to the 'GOTO' display.



(If an *incorrect* password has been entered and the controller is still 'locked' then pressing *Scroll* at this point will simply return you to the *ACCESS* list header.)

Note: From this *code* display, you can access "read only" configuration level by pressing  and  together.

To escape, press  and  together

3.1.3 Level selection

The 'Goto' display allows you to select the required access level.

Use  and  to select from the following display codes: **OPER**: Operator level
FULL: Full level
Edi t: Edit level
conf: Configuration level

Press the Scroll button

If you selected either 'OPER', 'FULL' or 'Edi t' level you will be returned to the 'ACCS list header in the level that you chose. If you selected 'conf', you will get an alternative display showing 'CONF' in the upper readout (see below).

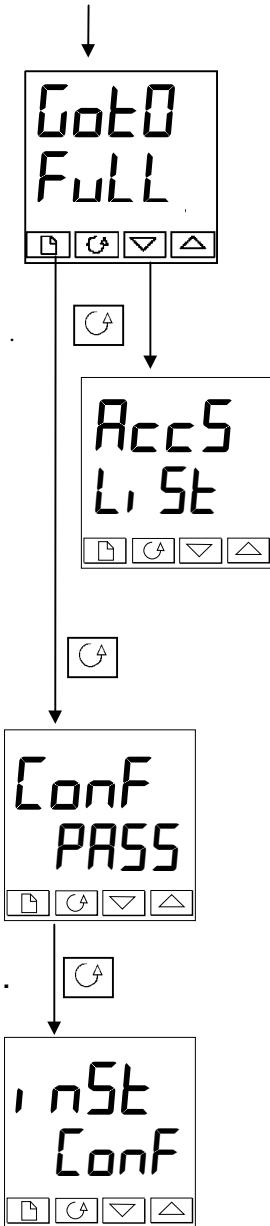

3.1.4 Configuration password

When the 'CONF' display appears, you must enter the Configuration password in order to gain access to Configuration level. Do this by repeating the password entry procedure described in the previous section. The configuration password is set to '2' when the controller is shipped from the factory. If you need to change the configuration password, see Chapter 5, *Configuration*

Press the Scroll button

3.1.5 Configuration level

The first display of configuration is shown. See chapter 5, *Configuration* for details of the configuration parameters. For instructions on leaving configuration level see Chapter 5, *Configuration*.

3.1.1 Returning to Operator Level

To return to operator level from either 'FULL' or 'EDIT' level, repeat entry of the password and select 'OPER' on the 'EDIT' display.

In 'EDIT' level the controller will automatically return to operator level if no button is pressed for 45 seconds.



3.3 EDIT LEVEL

Edit level is used to set which parameters you can see and adjust in Operator level. It also gives access to the 'Promote' feature which allows you to select and add ('Promote') up to twelve parameters into the Home display list, thereby giving simple access to commonly used parameters.

3.1.2 Setting operator access to a parameter

First you must select EDIT level, as shown on the previous page.

Once in EDIT level you select a list or a parameter within a list in the same way as you would in Operator or Full level. That is, you move from list header to list header by pressing the Page button, and from parameter to parameter within each list using the Scroll button. **However, in Edit level what is displayed is not the value of a selected parameter but a code representing the parameter's availability in Operator level.**

When you have selected the required parameter, use the  and  buttons to set its availability in operator level.

There are four codes:

- ALtR** Makes a parameter alterable in Operator level
- PrO** Promotes a parameter into the Home display list
- rEAd** Makes a parameter or list header read-only (*it can be viewed but not altered*)
- Hi dE** Hides a parameter or list header.

For example:



The parameter selected is the set point for Alarm 2 - Full Scale Low

It will be alterable in Operator level

3.1.3 Hiding or revealing a complete list

To hide a complete list of parameters, all you have to do is hide the list header. If a list header is selected only two selections are available: *rEAd* and *Hi dE*.

(It is not possible to hide the '*ACCS*' list which will always display the code: '*L, St*'.)

3.1.4 Promoting a parameter

Scroll through the lists to the required parameter and choose the '*Pro*' code. The parameter is then automatically added (promoted) into the Home display list (the parameter will also be accessible as normal from the standard lists. a maximum of 12 parameters can be promoted. Promoted parameters are automatically 'alterable'.

4. Chapter 4 TUNING

- 4. Chapter 4 TUNING 1**
- 4.1. WHAT IS TUNING?..... 2**
- 4.2. AUTOMATIC TUNING 3**
 - 4.2.1. Heating and Cooling Output Cycle Times 3
- 4.3. HOW TO TUNE 4**
 - 4.3.1. Typical automatic tuning cycle 5
 - 4.3.2. Calculation of the cutback values..... 5
- 4.4. MANUAL TUNING 6**
 - 4.4.1. Setting the cutback values 7
 - 4.4.2. Integrating action and manual reset..... 8
 - 4.4.3. Automatic droop compensation (Adc) 8

4.1. WHAT IS TUNING?

Before tuning please read Chapter 1, *Operation*, to learn how to select and change a parameter.

In tuning you match the characteristics of the controller to that of the process being controlled in order to obtain good control. Good control means:

Stable ‘straight-line’ control of the temperature at setpoint without fluctuation

Acceptable overshoot or undershoot of the temperature setpoint

Quick response to deviations from the setpoint caused by external disturbances, thereby restoring the temperature rapidly to the setpoint value.

Tuning involves calculating and setting the value of the parameters listed in Table 4-1. These parameters appear in the *P, I, D* list.

Parameter	Code	Meaning or Function
Proportional band	<i>Pb</i>	The bandwidth in display units over which the output power is proportioned between minimum and maximum.
Integral time	<i>t_i</i>	Determines the time taken by the controller to remove steady-state error signals.
Derivative time	<i>t_d</i>	Determines how strongly the controller will react to the rate-of-change of the measured value.
Low cutback	<i>Lcb</i>	The number of display units below setpoint at which the controller will cutback the output power in order to prevent overshoot on heat up.
High Cutback	<i>Hcb</i>	The number of display units above setpoint at which the controller will increase the output power in order to prevent undershoot on cool down.
Relative cool gain	<i>rELC</i>	Only present if cooling has been configured. Sets the cooling proportional band by dividing the <i>Pb</i> value by the <i>rELC</i> value.

Table 4-1 Tuning parameters

4.2. AUTOMATIC TUNING

This method automatically determines the value of the parameters listed in table 4-1 on the previous page.

The 2216e uses a 'one-shot' tuner which works by switching the output on and off to induce an oscillation in the measured value. From the amplitude and period of the oscillation, it calculates the tuning parameter values.

If the process cannot tolerate full heating or cooling being applied during tuning, then the level of heating or cooling can be restricted by setting the heating and cooling power limits in the Output list. However, the measured value *must* oscillate to some degree for the tuner to be able to calculate values

A One-shot Tune can be performed at any time but normally it is performed only once during the initial commissioning of the process. However, if the process under control subsequently becomes unstable (because its characteristics have changed), you can re-tune again for the new conditions.

It is best to start tuning with the process at ambient temperature. This allows the tuner to calculate more accurately the low cutback and high cutback values that restrict the amount of overshoot or undershoot.

4.2.1. Heating and Cooling Output Cycle Times

Before commencing a tuning cycle, set the values of CYC.H (heat cycle time) and CYC.C (cool cycle time) in the op (output list). These values apply if you are using a logic, relay or triac output. They have no effect on a DC output.

A logic output switching a solid state relay can be set to values such as 1 sec.

A relay or triac output should be set to 20 sec.

4.3. HOW TO TUNE

1. Set the setpoint to the value at which you will normally operate the process.
2. In the 'Atun' list, select 'tunE' and set it to 'on'
3. Press the Page and Scroll buttons together to return to the Home display. The display will flash 'tunE' to indicate that tuning is in progress.
4. The controller will induce an oscillation in the temperature by turning the heating on and then off. The first cycle will not complete until the measured value has reached the required setpoint.
5. After two cycles of oscillation the tuning will be completed and the tuner will switch itself off.
6. The controller will then calculate the tuning parameters listed in Table 4-1 and will resume normal control action.

If you want 'Proportional only' or 'PD' or 'PI' control, you should set the 't1' or 'td' parameters to OFF before commencing the tuning cycle. The tuner will leave them off and will not calculate a value for them.

For valve position tuning and set-up, please refer to Appendix D.

4.3.1. Typical automatic tuning cycle

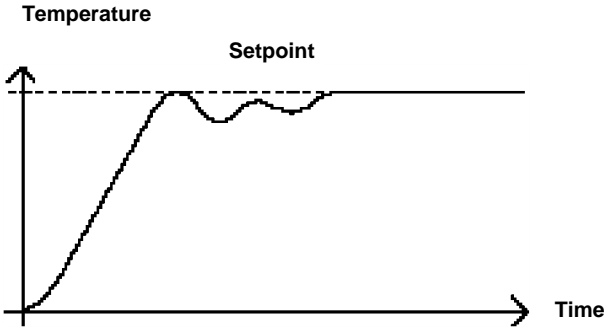

4.3.2. Calculation of the cutback values

Low cutback and *High cutback* are values that restrict the amount of overshoot or undershoot that occur during large step changes in temperature (for example, under startup conditions).

If either low cutback or high cutback is set to 'Auto' the values will be fixed at three times the proportional band, and will not be changed during automatic tuning.

4.4. MANUAL TUNING

If for any reason automatic tuning gives unsatisfactory results, you can tune the controller manually. There are a number of standard methods for manual tuning. The one described here is the Ziegler-Nichols method.

With the process at its normal running temperature:

1. Set the Integral Time ' t_i ' and the Derivative Time ' t_d ' to *OFF*.
2. Set High Cutback and Low Cutback, ' Hcb ' and ' Lcb ', to '*Auto*'
3. Ignore the fact that the temperature may not settle precisely at the setpoint
4. If the temperature is stable, reduce the proportional band ' Pb ' so that the temperature just starts to oscillate. If the temperature is already oscillating, increase the proportional band until it just stops oscillating. Allow enough time between each adjustment for the loop to stabilise. Make a note of the proportional band value ' B ' and the period of oscillation ' T '.
5. Set the P_b , t_i , t_d parameter values according to the calculations given in Table 4-2.

Type of control	Proportional band ' P_b '	Integral time ' t_i '	Derivative time ' t_d '
Proportional only	2xB	OFF	OFF
P + I control	2.2xB	0.8xT	OFF
P + I + D control	1.7xB	0.5xT	0.12xT

Table 4-2 Tuning values

4.4.1. Setting the cutback values

The above procedure sets up the parameters for optimum steady state control. If unacceptable levels of overshoot or undershoot occur during start-up or for large step changes in temperature, then manually set the cutback parameters L_{cb} and H_{cb} .

Proceed as follows:

1. Set the low and high cutback values to three proportional bandwidths (that is to say, $L_{cb} = H_{cb} = 3 \times P_b$).
2. Note the level of overshoot or undershoot that occurs for large temperature changes (see the diagrams below).

In example (a) increase L_{cb} by the overshoot value. In example (b) reduce L_{cb} by the undershoot value.

Example (a)

Temperature

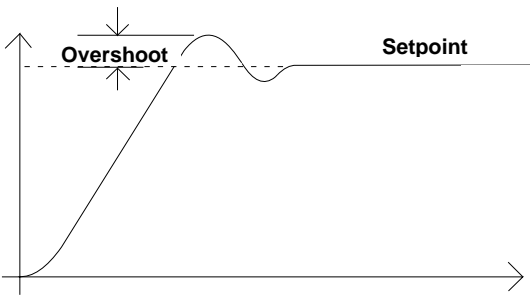

Example (b)

Temperature

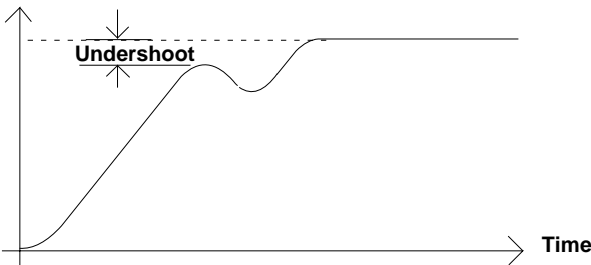

Where the temperature approaches setpoint from above, you can set H_{cb} in a similar manner.

4.4.2. Integrating action and manual reset

In a full three-term controller (that is, a PID controller), the integral term 'ti' automatically removes steady state errors from the setpoint. If the controller is set up to work in two-term mode (that is, PD mode), the integral term will be set to **OFF**. Under these conditions the measured value may not settle precisely at setpoint. When the integral term is set to OFF the parameter *manual reset* (code **RES**) appears in the **P, d, L, St** in 'FULL' Access level. This parameter represents the value of the power output that will be delivered when the error is zero. You may set this value manually in order to remove the steady state error.

4.4.3. Automatic droop compensation (Adc)

The steady state error from the setpoint, which occurs when the integral term is set to OFF, is sometimes referred to as 'droop'. **Adc** automatically calculates the manual reset value in order to remove this droop. To use this facility, you must first allow the temperature to stabilise. Then, in the autotune parameter list, you must set **Adc** to 'CALC'. The controller will then calculate a new value for manual reset, and switch **Adc** to 'MAN'.

Adc can be repeated as often as you require but between each adjustment you must allow time for the temperature to stabilise.

5. Chapter 5 CONFIGURATION

5. Chapter 5 CONFIGURATION.....	1
5.1 SELECTING CONFIGURATION LEVEL.....	2
5.2 SELECTING A CONFIGURATION PARAMETER	3
5.3 LEAVING CONFIGURATION LEVEL	3
5.4 STEPS INVOLVED IN CONFIGURING A CONTROLLER	3
5.5 NAVIGATION DIAGRAM (PART A)	4
5.6 NAVIGATION DIAGRAM (PART B)	5
5.7 CONFIGURATION PARAMETER TABLES.....	6
5.8 CONFIGURATION OF DIGITAL COMMUNICATIONS.....	14
5.8.1. To Configure the Function and Baud Rate.....	14
5.8.2. To Set the Instrument Address.....	15
5.9 DEVICENET.....	15
5.9.1. The EDS File.....	15
5.9.2. ODVA Compliance.....	15

WARNING

Configuration is protected by a password and should be carried out by an authorised person. Incorrect configuration could result in damage to the process being controlled and/or personal injury. It is the responsibility of the person commissioning the process to ensure that the configuration is correct.

Whenever the configuration level is accessed, all controller outputs are held in the power off state and control operation is suspended

5.2 SELECTING A CONFIGURATION PARAMETER

(continued from previous page)

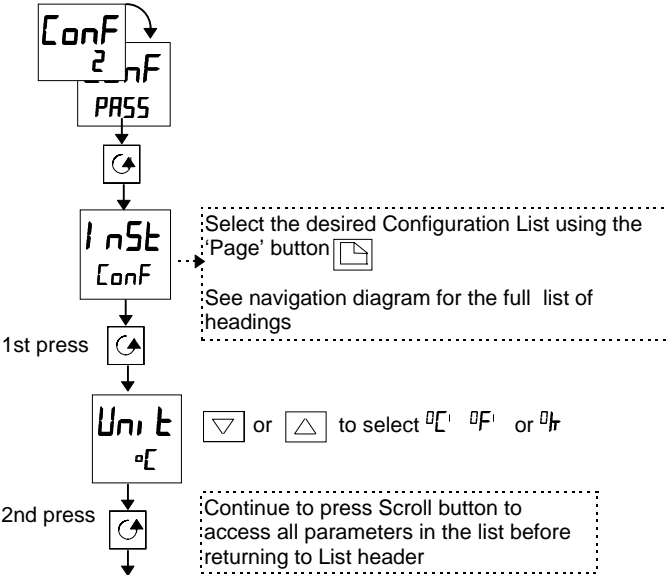

Figure 5.2

5.3 LEAVING CONFIGURATION LEVEL

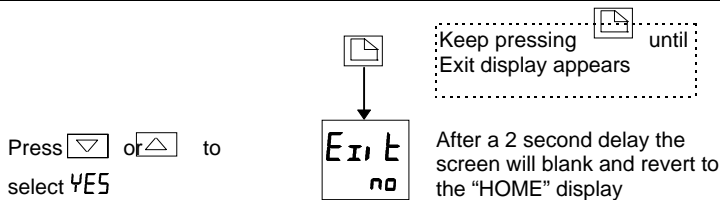

Figure 5.3

5.4 STEPS INVOLVED IN CONFIGURING A CONTROLLER

The navigation diagram which follows shows the general location of parameters which define the way in which the controller works. They are grouped under headings.

The actual parameters shown in your controller may differ slightly since some appear only as a result of selecting others. A full list of possibilities is included in the PARAMETER TABLES which follow the navigation diagram.

5.5 NAVIGATION DIAGRAM (PART A)

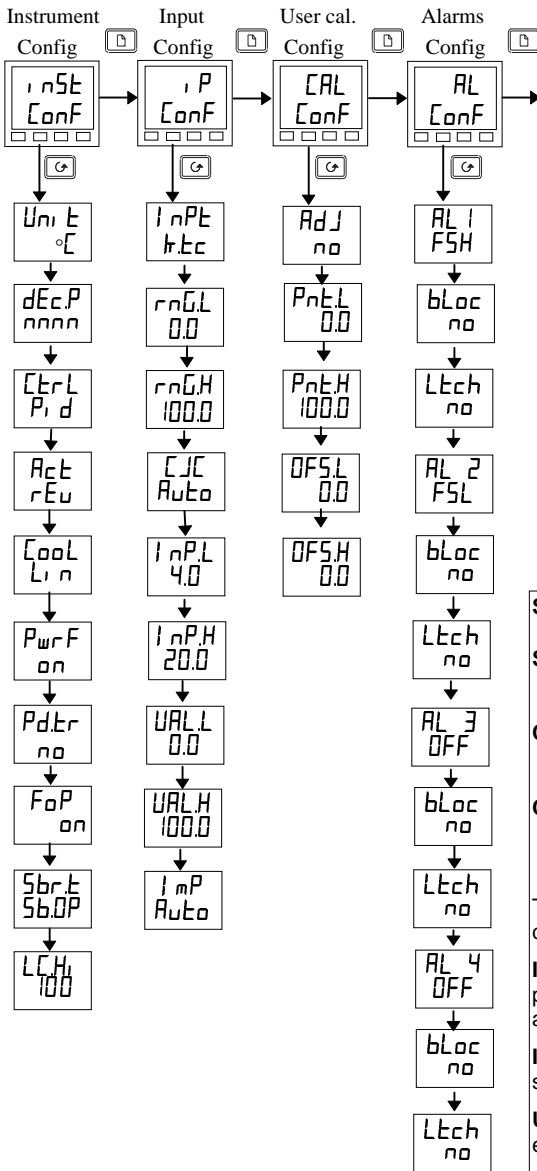

SUMMARY

Step through List Headers using the 'Page' button

Choose a parameter from a list using the 'Scroll' button

Change value using the 'Raise/Lower' buttons

The first four headings set up the controller functions, as follows:

Instrument Config. - Groups those parameters associated with the display and control action

Input Config. - selects the input sensor type

User cal Config. - to calibrate to external reference sources

Alarms Config. - sets up the alarm types

Fig 5.4a Navigation Diagram (Part A)

5.6 NAVIGATION DIAGRAM (PART B)

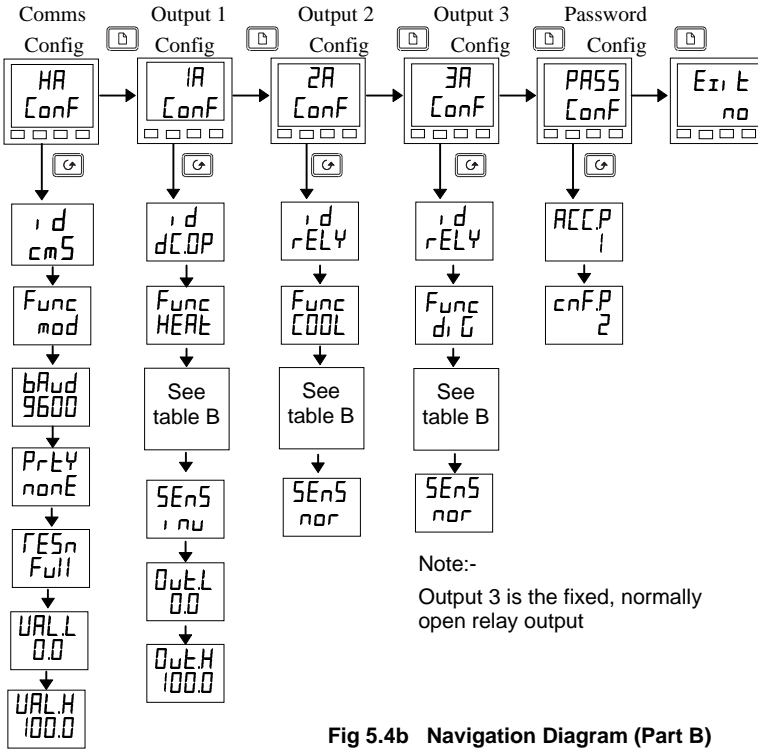

Fig 5.4b Navigation Diagram (Part B)

Heading	Input/Output Functions	Wiring Terminals
The first four headings set up the controller functions as follows:		
i nSt Conf	Sets up display and control parameters	Not applicable
i P Conf	Selects the input sensor type	Not applicable
CLL Conf	To calibrate to external reference sources	Not applicable
AL Conf	Sets up the alarm types	Not applicable
The remaining headings configure the controller input/output functions. The upper readout corresponds to rear terminal numbers associated with a particular i/o		
HA Conf	Sets up digital comms. type	HA to HF
1A Conf	Sets up the output 1 module	1A & 1B
2A Conf	Sets up the output 2 module	2A & 2B
3A Conf	Sets up the action of the relay on output 4	3A to 3C
PASS Conf	To choose new passwords	
Exit Conf	To leave configuration level and return to operator level	

5.7 CONFIGURATION PARAMETER TABLES

Name	Parameter description	Values	Meaning
<i>Unit</i>	Instrument configuration		
<i>Unit</i>	Instrument units	°C	Centigrade (default UK)
		°F	Fahrenheit (default USA)
		°K	Kelvin
		none	Display units will be blanked
<i>DecP</i>	Decimal places in the displayed value	none	None
		none.n	One
		none.nn	Two
<i>Ctrl</i>	Control type	On/Off	On/off control
		PID	PID control
<i>Act</i>	Control action	rev	Reverse acting (required for temperature control) - output decreases on approach to setpoint.
		dir	Direct acting
<i>cool</i>	Type of cooling	Lin	Linear
		oil	Oil (50mS min on time)
		H2O	Water(non-linear)
		FAN	Fan (0.5S min on time)
<i>PowerF</i>	Power feedback	on	Power feedback is on (compensates for changes in supply voltage)
		OFF	Power feedback is off
<i>Pdtr</i>	Bumpless Manual/Auto transfer when using PD control	no	Non-bumpless transfer
		YES	Bumpless transfer (auto to manual and manual to auto)
<i>ForP</i>	Forced manual output	no	Non-bumpless transfer
		YES	Bumpless transfer (auto to manual and manual to auto)
<i>Sbrk</i>	Sensor break output	SB.OP	Go to pre-set value (maintains output at a known, safe level)
		HoLd	Freeze output (maintains output at value immediately before break)
<i>LCHi</i>	Load current scaling factor	100	See Chapter 9

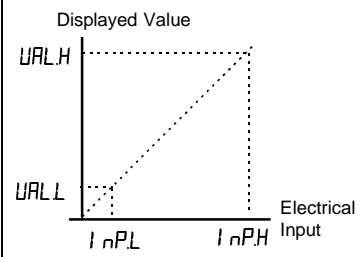

Factory default parameter values and states are included where applicable and are indicated by the shaded areas in the following tables.

Name	Parameter description	Value	Meaning
i P	Input configuration		
i nPt	Input type NOTE: <i>After selecting an input type, do not forget to adjust the setpoint limits in Full Access level</i>	J.t.c K.t.c L.t.c R.t.c B.t.c N.t.c T.t.c S.t.c PL.2 r.t.d C.t.c mV v.o.l.t	J thermocouple (default USA) K thermocouple (default UK) L thermocouple R thermocouple (Pt/Pt13%Rh) B thermocouple (Pt30%Rh/Pt6%Rh) N thermocouple T thermocouple S thermocouple (Pt/Pt10%Rh) PL 2 thermocouple 100Ω platinum resistance thermometer. Custom downloaded input type. The default is C thermocouple, or the name of the downloaded custom input will be displayed. Linear millivolt (Also mA input via an external 2.49Ω current sense resistor) Linear voltage
r nG.L	Input range low		Display low range for input
r nG.H	Input range high		Display high range for input
CJC	CJC ref. temperature <i>(CJC does not appear for linear inputs)</i>	A.u.t.o 0°C 45°C 50°C	Automatic cold junction compensation 0°C external reference 45°C external reference 50°C external reference
Linear Input Scaling - The next 4 parameters only appear if a linear input is chosen			
i nPL i nPH UALL UALH			Input value low Input value high Displayed reading low Displayed reading high
i mP	Sensor break input impedance trip level	OFF A.u.t.o H_i H_i H_i	Sensor break detection is disabled <i>Appears for mV or V inputs only</i> Trip level set by the sensor input table Trip level set at 7.5KΩ Trip level set at 15KΩ (must be selected when v.o.l.t input is enabled)

Name	Parameter description	Value	Meaning
------	-----------------------	-------	---------

CR	User calibration config.		See Chapter 6 - User calibration
AdJ	User cal enable	no	User calibration is disabled
		YES	User calibration is enabled
Pnt.L	User calibration point low	0	This is the value (in display units) at which a User last performed a low point calibration
Pnt.H	User calibration point high	100	This is the value (in display units) at which a User last performed a high point calibration
OFF.L	Low point calibration offset	0	Offset, in display units, at the user low calibration point 'Pnt.L'. This value is automatically calculated when performing low point calibration.
OFF.H	High point calibration offset	0	Offset, in display units, at the user high calibration point 'Pnt.H'. This value is automatically calculated when performing a high point calibration.

*If User calibration is enabled, then the User calibration parameters will appear in the Input list of Operator Full access level. See Chapter 6, *User calibration*.

Name	Parameter description	Values
------	-----------------------	--------

<i>RL</i>	Alarm configuration	Values	Defaults if not specified
<i>RL1</i>	Alarm 1 Type	As table A	<i>OFF</i>
<i>bLoc</i>	Alarm 1 Blocking ⁽¹⁾	<i>no</i> : YES	<i>no</i>
<i>Ltch</i>	Alarm 1 Latching	<i>no</i> : YES	<i>no</i>
<i>RL2</i>	Alarm 2 Type	As table A	<i>OFF</i>
<i>bLoc</i>	Alarm 2 Blocking ⁽¹⁾	<i>no</i> : YES	<i>no</i>
<i>Ltch</i>	Alarm 2 Latching	<i>no</i> : YES	<i>no</i>
<i>RL3</i>	Alarm 3 Type	As table A	<i>OFF</i>
<i>bLoc</i>	Alarm 3 Blocking ⁽¹⁾	<i>no</i> : YES	<i>no</i>
<i>Ltch</i>	Alarm 3 Latching	<i>no</i> : YES	<i>no</i>
<i>RL4</i>	Alarm 4 Type	As table A	<i>OFF</i>
<i>bLoc</i>	Alarm 4 Blocking ⁽¹⁾	<i>no</i> : YES	<i>no</i>
<i>Ltch</i>	Alarm 4 Latching	<i>no</i> : YES	<i>no</i>

Table A: Alarm types

<i>OFF</i>	No alarm
<i>FSL</i>	Full scale low
<i>FSH</i>	Full scale high
<i>dEw</i>	Deviation band
<i>dHi</i>	Deviation high
<i>dLo</i>	Deviation low
<i>Lcr</i>	Low current
<i>Hcr</i>	High current

(1) Blocking allows the alarm to become active only after it has first entered a safe state.





These are ‘soft’ alarms ie. Indication only. They would normally be attached to an output. See Chapter 7 for a step by step guide.

Name	Parameter description	Functions	Meaning
HR	Comms module config	Functions	Meaning
<i>i d</i>	Identity of the option installed	<i>PdS,</i> <i>cmS</i>	PDS setpoint input EIA 485 comms module
<i>Func</i>	Function		
	<i>The following parameters will appear if the EIA-485 option is installed</i>	<i>cmS</i> <i>nonE</i>	Modbus protocol None
	<i>The following parameters will appear if the PDS setpoint input option is installed.</i>	<i>nonE</i> <i>SP, P</i>	No PDS function PDS setpoint input
<i>VAL.L</i>	PDS displayed value low	Range = -999 to 9999	
<i>VAL.H</i>	PDS displayed value high	Range = -999 to 9999	
	<i>The following parameters will appear if the function chosen is Modbus protocol.</i>		
<i>baud</i>	Baud Rate	<i>1200</i> <i>2400</i> <i>4800</i> <i>9600</i> <i>1920</i> (19200)	
<i>*Prty</i>	Comms Parity	<i>nonE</i> <i>EuEn</i> <i>Odd</i>	No parity Even parity Odd parity
<i>*resn</i>	Comms Resolution	<i>FuLL</i> <i>int</i>	Full resolution Integer resolution

* Not used with some communication protocols. Please consult factory.

Name	Parameter description	Function	Meaning
<i>IR</i>	Output 1 configuration	Function	Meaning
<i>id</i>	Identity of module installed	nonE rELY dC.OP LoG SSr	No module fitted Relay output DC output (isolated) Logic or PDS output Triac output
<i>Func</i>	Function <i>Only appear for id = dC.OP</i> <i>Only appear for id = dC.OP</i> <i>Only appear for id = dC.OP</i> <i>Only appear for id = LoG</i> <i>Only appear for id = LoG</i>	nonE dLG HEAT COOL OP PU Err wSP SSr.1 SSr.2	Function set by <i>dLG</i> Heating output Cooling output Retransmission of output demand Retransmission of process value Retransmission of error Retransmission of setpoint PDS mode 1 heating PDS mode 2 heating
For <i>Function = dLG</i> go to table B on page 5-12			
<i>SEN5</i>	Sense of output	nor inu	Normal (e.g. heating and cooling) Inverted (alarms - de-energise in alarm)
DC output scaling For <i>id = dC.OP</i> the following parameters appear			
<i>OUT.L</i>	DC output minimum		0mA to 'OUT.H'
<i>OUT.H</i>	DC output maximum		'OUT.L' to 20mA

Table B The following parameters appear if 'd1 G' is chosen as the function.			
d1 G.F	Digital output functions	<i>noCH</i>	No change
	Any number of the functions listed can be combined on to the output.	<i>cLr</i>	Clear all existing functions
	Use the  and  buttons to select a desired digital function. After two seconds the display will blink and return to the 'noCH' display. Use the arrows again to scroll through the function list.	<i>1 - - -</i>	Alarm 1*
	The previously selected function display will show two decimal points indicating that it has been added to the output.	<i>2 - - -</i>	Alarm 2*
		<i>3 - - -</i>	Alarm 3*
		<i>4 - - -</i>	Alarm 4*
		<i>mAn</i>	Manual/Auto
		<i>Sbr</i>	Sensor break
		<i>Lbr</i>	Loop break
		<i>HtRF</i>	PDS Heater fail
		<i>LdF</i>	PDS Load failure
		<i>End</i>	End of program
		<i>SPAn</i>	PV out of range
		<i>SSrF</i>	PDS Solid state relay failure
	<i>nwAL</i>	New alarm	
	<i>rmEF</i>	Remote setpoint failure	

*In place of the dashes, the last three characters indicate the alarm type as per table A in the AL list: eg *IFSL* = Full Scale Low

If an alarm is not configured the displayed name will differ: e.g. 'AL 1' will be shown, for the first alarm

Name	Parameter description	Function	Meaning
------	-----------------------	----------	---------

2A	Output 2 configuration	Function	Meaning
Func	Identity of module installed	nonE rELY LoG SSr	No module fitted Relay output Logic output Triac output
	Function	nonE	none
	Outputs	dIG HEAT COOL	Function set by d1 GF Heating output Cooling output
	Logic inputs	mAn rmt SP2 t, H Ac.AL Loc.b rSEt Stby	Manual mode select Remote setpoint select Setpoint 2 select Integral hold Acknowledge alarms Lock buttons (keypad) Ramp/dwell reset Standby - ALL outputs = OFF

For Func = d1 G go to table B on previous page

SEN5	Sense of output	nor inu	Normal (<i>heat and cool outputs</i>) Inverted (<i>alarms - de-energise in alarm</i>)
------	-----------------	------------	--

3A	Output 3 configuration	As per output AA configuration
----	------------------------	--------------------------------

PASS	Password list
ACCP	FULL or Ed1 E level password (default = 1)
CNFP	Configuration level Password (default = 2)

EXIT	Exit Configuration	no YES
------	--------------------	--------

5.8 CONFIGURATION OF DIGITAL COMMUNICATIONS

The 2216 controller can be fitted with the following digital communications modules:-

Protocol	Module Fitted	Order Code
ModBus	2-wire RS485	2YM
	4-wire RS422	2FM
	RS232	2AM
EI-Bisynch	2-wire RS485	2YE
	4-wire RS422	2FE
	RS232	2AE
DeviceNet		2DN

5.8.1 To Configure the Function, and Baud Rate

All devices on a network must have the same Baud Rate, Parity and Resolution.



Comms configuration list - HA



Identity of module

This is a read-only parameter displaying the identity of the module fitted



Function

Set *Func* = *CmS* to select the protocol. Ensure that the correct Comms module has been fitted. To disable comms set *Func* to *nonE*.



Baud Rate

Press or to set the Baud Rate. The choices are:- 1200, 2400, 4800, 9600, 19,200 for Modbus and EI-Bisynch 125(K), 250(K), or 500(K) for DeviceNet

Parity and Resolution can be set by the same procedure. These will normally be set to None and Full respectively

5.8.2 To Set Instrument Address

All devices on a network must have a different node address.

Instrument address is set in operator level.

Exit configuration level. This is described on page 5-3.



Comms list

From the HOME display, press the Page button until you reach the **cm5** list

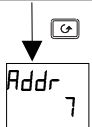

Address

Press the raise or lower buttons until the desired address is set.

The choices are:-

0 to 99 for Modbus and EI-Bisynch

0 to 64 for DeviceNet.

5.9 DEVICENET

The following is applicable to DeviceNet only.

5.9.1 The EDS File

The EDS (Electronic Data Sheet) file for the Series 2200e is named 2K2DN.EDS and is available from your supplier, or electronically by going to Web site (www.eurotherm.com). The EDS file is designed to automate the DeviceNet network configuration process by precisely defining vendor-specific and required device parameter information. Following a data sheet metaphor, the EDS file describes a device's configurable parameters, including its legal and default values and the public interfaces to those parameters. Software configuration tools utilize the EDS files to configure a DeviceNet network.

5.9.2 ODVA Compliance

This interface has been tested to comply with the full requirements of the ODVA (Open DeviceNet Vendors Association) conformity tests.

6 Chapter 6 USER CALIBRATION

- 6 Chapter 6 USER CALIBRATION 1
- 6.8 WHAT IS THE PURPOSE OF USER CALIBRATION? 2
- 6.9 USER CALIBRATION ENABLE 3
- 6.10 SINGLE POINT CALIBRATION 4
- 6.11 TWO POINT CALIBRATION 5
- 6.12 CALIBRATION POINTS AND CALIBRATION OFFSETS 6

6.8 WHAT IS THE PURPOSE OF USER CALIBRATION?

The basic calibration of the controller is highly stable and set for life. User calibration allows you to offset the 'permanent' factory calibration to either:

1. Calibrate the controller to your reference standards
2. Match the calibration of the controller to that of a particular transducer or sensor input
3. Calibrate the controller to suit the characteristics of a particular installation.

User calibration works by introducing zero and span offsets onto the factory set calibration. The factory set calibration can always be retrieved.

To understand how to select and change parameters in this chapter you will need to have read Chapter 2 - *Operation*, Chapter 3- *Access Levels* and Chapter 5 - *Configuration*.

6.9 USER CALIBRATION ENABLE

The User calibration facility must first be enabled in configuration level by setting the parameter 'Adj' in the CAL CONF list to 'YES'. This will make the User calibration parameters appear in Operator 'FULL' level.

Select configuration level as shown in Chapter 5, Configuration

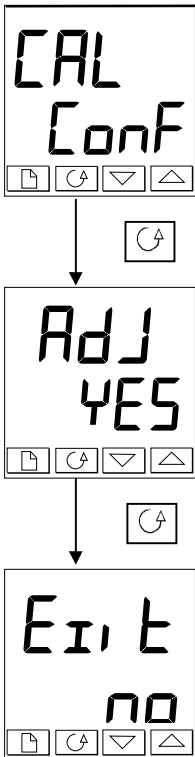

The User calibration configuration List

Press until you reach the 'CAL CONF list

press the Scroll button until you reach

User calibration enable

Use or to select:

YES: Calibration enable
no: Calibration disabled

Press and together to go to the Exit display

Exit configuration

Use or to select 'YES' and return to Operator level.

6.10 SINGLE POINT CALIBRATION

Your controller is calibrated for life against known reference sources during manufacture. A calibration offset is often used to allow the controller to compensate for sensor and other system errors. The normal procedure is to set up the system under test against a known independent reference, as follows:

Set up the process to be calibrated such that the known reference displays the required value (temperature).

Observe the reading on the controller. If it is different, proceed as follows:

Select **FULL** Access level as described in Chapter 3

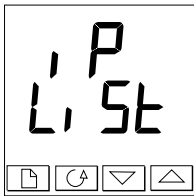



Input list header

Press  until you reach the input list header.



Press Scroll until you reach the 'CAL' display

Calibration type

Use  or  to select either 'FACT' or 'USER'.
Selecting 'FACT' will reinstate the factory calibration and hide the following User calibration parameters.
Selecting 'USER' will reinstate any previously set User calibration and make available the User parameters, as follows:

Press the Scroll button

Calibrate low point?

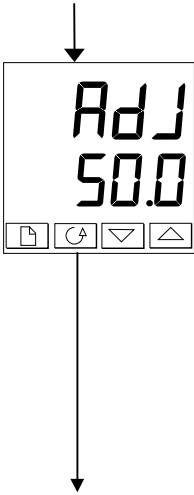

Use  or  to select 'YES'.
Selecting 'no' will hide the next parameter

*Press the Scroll button
continued on the next page*



Adjust the low point calibration



The controller will display the current measured input value in the lower readout.

Use  or  to adjust the reading to the reference source value, if different.

After a two second delay the display will blink and the reading will change to the new, calibrated value. You can calibrate at any point over the entire display range

This is a single point calibration which applies a fixed offset over the full display range of the controller.

The calibration is now complete. You can return to the factory calibration at any time by select '**FACT**' in the CAL display shown earlier.

Press  and  together to return to the Home display

To protect the calibration against unauthorised adjustment return to Operator level and make sure that the calibration parameters are hidden. Parameters are hidden using the '**Edi t**' facility describe in Chapter 3.

6.11 TWO POINT CALIBRATION

The previous section described how to perform a single point calibration which applies a fixed offset over the full display range of the controller. A two-point calibration is used to calibrate the controller at two points and apply a straight line between them. Any readings above or below the two calibration points will be an extension of this straight line. For this reason it is best to calibrate with the two points as far apart as possible.

Proceed as follows:

1. Decide upon the low and high points at which you wish to calibrate.
2. Perform a single point calibration at the low calibration point in the manner described above
3. Set the process under calibration such that the known reference exhibits the required higher Process Value (temperature) and allow to stabilise.
4. Press the Scroll button to obtain the high calibration point as shown in the following diagrams.



Calibrate high point?

Use or to select 'Hi'.

Press the Scroll button



Adjust the high point calibration

The controller will display the current measured input value in the lower readout.

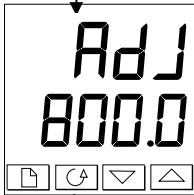

Use or to adjust the reading to the reference source value, if different.

After a two second delay the display will blink and the reading will change to the new, calibrated value.

The calibration is now complete. You can return to the factory calibration at any time by select 'FACT' in the CAL display shown earlier.

Press and together to return to the Home display

To protect the calibration against unauthorised adjustment return to Operator level and make sure that the calibration parameters are hidden. Parameters are hidden using the 'Edi E' facility described in Chapter 3.

6.12 CALIBRATION POINTS AND CALIBRATION OFFSETS

If you wish to see the points at which the User calibration was performed and the value of the offsets introduced these are shown in Configuration, under CAL CONF. The parameters are:

Name	Parameter description	Meaning
PnEL	User low calibration point	This is the value (in display units) at which a User last performed an 'AdjL' (adjust low calibration).
PnEH	User high calibration point	This is the value (in display units) at which a User last performed an 'AdjH' (adjust high calibration).
OF5L	Low point calibration offset	Offset, in display units, at the user low calibration point 'PnEL'.
OF5H	High point calibration offset	Offset, in display units, at the user high calibration point 'PnEH'.

7 Chapter 7 ALARM CONFIGURATION

- 7 Chapter 7 ALARM CONFIGURATION..... 1**
- 7.1 DEFINITION OF ALARMS AND EVENTS..... 2**
 - 7.1.1 Types Of Alarms..... 2
- 7.2 DIGITAL OUTPUT FUNCTIONS 4**
- 7.3 STEP1 - CONFIGURING THE FOUR ‘SOFT’ ALARMS 5**
- 7.4 STEP 2 - ATTACHING AN ALARM TO A PHYSICAL OUTPUT 6**
- 7.5 STEP 3 - GROUPING ALARMS ON A SINGLE OUTPUT 7**
- 7.6 STEP 4 - REMOVING ALARMS FROM AN OUTPUT 7**

The 2200e series controllers are capable of very sophisticated alarm strategies and, although setting up of alarms has already been covered in previous chapters, this section has been included to enable operators and commissioning engineers to design their own strategies for optimum plant operation.

7.1 DEFINITION OF ALARMS AND EVENTS

See also section 1.11 for further information on Alarms.

Alarms are used to alert an operator when a pre-set level or condition has been exceeded. They are normally used to switch an output - usually a relay - to provide interlocking of the machine or plant or external audio or visual indication of the condition.

Soft Alarms are indication only within the controller and are not attached to an output (relay).

Events - can also be alarms - but are generally defined as conditions which occur as part of the normal operation of the process. They do not generally require operator intervention.

Events are also referred to as **Digital Output Functions** (see Table B, page 5-12).

For the purposes of the operation of this instrument alarms and events can be considered the same.

7.1.1 Types Of Alarms

The use of alarms in the 2216e controller is extremely versatile.

Up to 4 alarms can be configured. Any combination of these 4 alarms can be attached to any one or more outputs, or any number of the available "soft" alarms can be combined to operate a single output.



Note: In a three term controller at least one of these outputs is used to maintain the required temperature of the process.

Outputs 1A and 2A

Are plug in modules.

Normally used for control outputs, eg. Heat and Cool, but can be used for alarm outputs.

Output 3A

Is a fixed relay.

Normally used for alarms or events, but can be used as control outputs.

There are seven process alarm types listed below. Alarm Types are found in configuration mode under the Alarm Config. List.

ALARMS

Full Scale High	The PV exceeds a set high level
Full Scale Low	The PV exceeds a set low level
Deviation Band	The difference between PV & SP is outside a set band
Deviation High	The difference between PV & SP is higher than a set level
Deviation Low	The difference between PV & SP is lower than a set level
High Current	The measured current returned from a PDS slave is higher than a set level. See also Chapter 9.
Low Current	The measured current returned from a PDS slave is lower than a set level. See also Chapter 9.

Each **alarm** can be set to:

Latching	Alarm is indicated until acknowledged (Off, Auto, MAN)
	Auto Acknowledge: (Llch Auto) If the alarm is acknowledged while the alarm condition is still present, it will cause the alarm to reset as soon as the alarm condition is removed.
	Manual Acknowledge: (Llch mAn) If the alarm is acknowledged while the alarm condition is still present, it will be ignored. A further acknowledgement is required when the alarm condition has been removed to cause the alarm to reset.
Blocking	Alarm occurs after it has been through a start up phase not in alarm condition.
Sense Of Output	Relay energised or de-energised in alarm condition. See also sections 1-12 and 7.4.
Soft Alarms	Indication only and do not operate an output.

See also Section 1.11 for further information on alarm types.

7.2 DIGITAL OUTPUT FUNCTIONS

In addition there are nine “digital output functions” used as events or alarms depending upon the requirements of the process under control:

Sensor Break	The input is open circuit
Loop Break	The controller does not measure a response to an output change
Load Failure	Used with PDS Mode 1 load failure. See also Chapter 9.
Manual	Controller in manual mode
PV Out Of Range	Process Variable too high or too low
Remote SP Fail	No signal measured at the remote set point input terminals
Heater Fail	Used with PDS Mode 2 heater open circuit. See also Chapter 9 .
SSR Fail	Used with PDS Mode 2 solid state relay open or short circuit. See also Chapter 9
Program END	Signals the end of a program
New Alarm	Signals a new alarm



The **Sense of the Output** can be set to relay energised or de-energised in the alarm condition for any of the above functions.

7.3 STEP1 - CONFIGURING THE FOUR 'SOFT' ALARMS

Soft alarms are indication only and do not operate a relay

Go To Configuration Level
Refer to Chapter 5

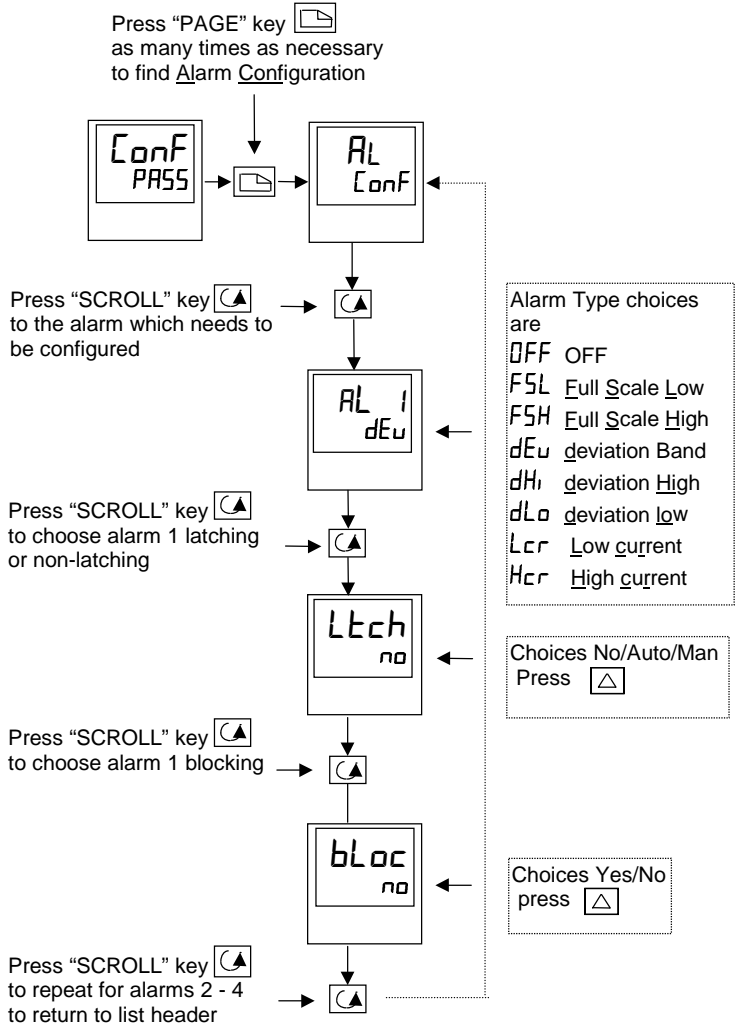

Figure 7.1

7.4 STEP 2 - ATTACHING AN ALARM TO A PHYSICAL OUTPUT

This may be necessary if:

- 1. The instrument has been supplied un-configured or it is required to re-configure
- 2. Alarm relays are added

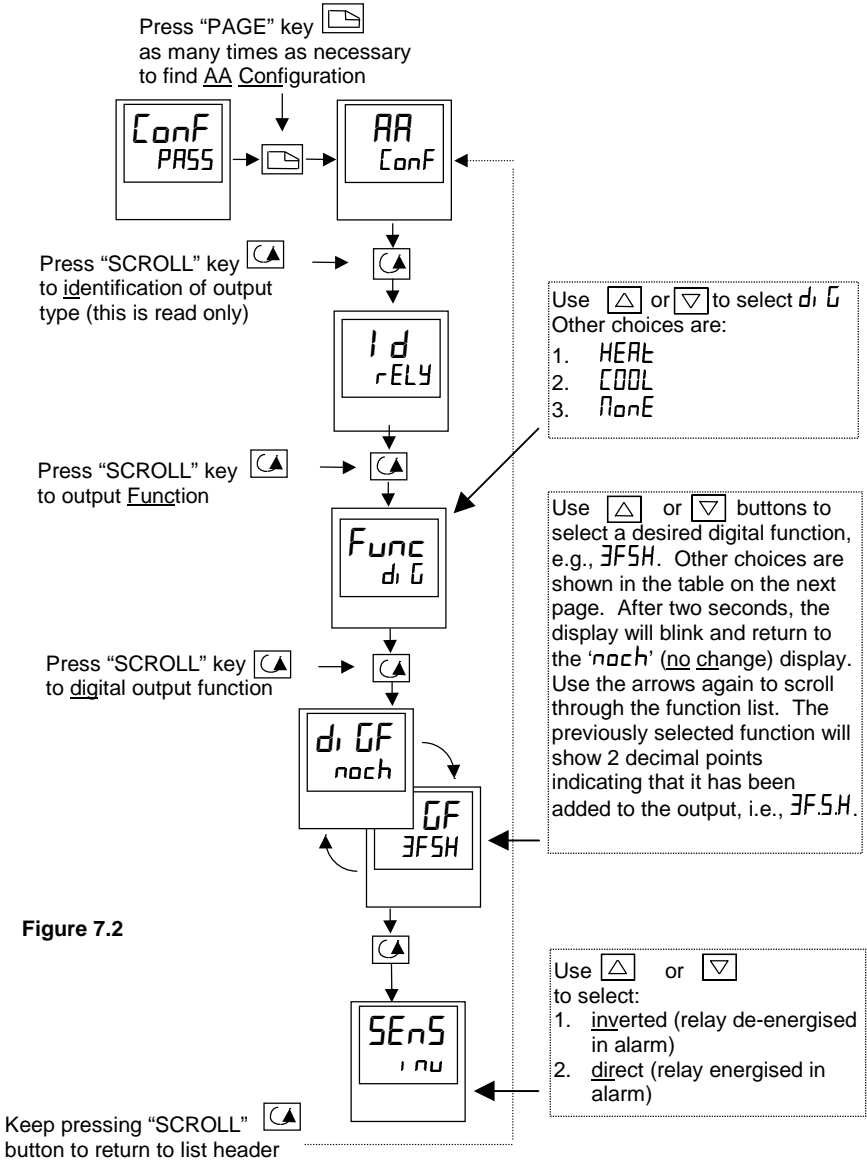

Figure 7.2

7.5 STEP 3 - GROUPING ALARMS ON A SINGLE OUTPUT

In the previous example one alarm condition is allocated to one output relay.

The 2216e controller allows alarms and events to be grouped on to a single output. These events are shown in the table below.

noch	No change
CLr	Clear all existing functions
1 - - -	Alarm 1*
2 - - -	Alarm 2*
3 - - -	Alarm 3*
4 - - -	Alarm 4*

* See Table B page 5-12

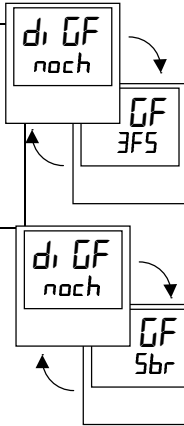

Press Δ until you reach the 1st soft alarm you wish to attach to an output, e.g., 3FSH. The display returns to no change after 2 sec. accepting the condition.

Press Δ until you reach the 2nd soft alarm you wish to attach to the output, e.g., 5br. The display returns to no change after 2 sec. accepting the condition.

Repeat for all alarms to be attached to the chosen output

See also section 1.12 for further information on alarm grouping.

Figure 7.3

7.6 STEP 4 - REMOVING ALARMS FROM AN OUTPUT

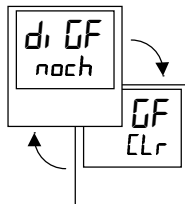

Each time you scroll through the table of alarms, note that 2 decimal points appear confirming acceptance that the particular alarm has been attached to the output, i.e., 3FSH, 5br, etc.

Press Δ once to show clear. After 2 sec. the lower readout reverts to no change clearing all events from the chosen output.

Figure 7.4

8. Chapter 8 MOTORISED VALVE CONTROL

8. Chapter 8 MOTORISED VALVE CONTROL 1

8.1. PARAMETERS FOR MOTORISED VALVE CONTROL 2

8.2. COMMISSIONING THE MOTORISED VALVE CONTROLLER 2

 8.2.1. Adjusting the minimum on-time 'OnT_H' 2

8.3. MOTORISED VALVE APPLICATIONS 3

 8.3.1. Auto Tuning..... 3

 8.3.2. Valve Positioner Set-up Table..... 3

8.1. PARAMETERS FOR MOTORISED VALVE CONTROL

The 2216e can be configured for motorised valve control as an alternative to the standard PID control algorithm. This algorithm is designed specifically for positioning motorised valves.

The motorised valve algorithm operates in the *Velocity* mode, which does not require a position feedback potentiometer for control purposes.

The following parameter list will appear in the navigation diagram shown in Chapter 1; if your controller is configured for motorised valve control.

Name	Description	Values		
ΔP	Output list	Min	Max	Default
<i>mTr</i>	Valve travel time in seconds. This is the time taken for the valve to travel from its fully closed position to its fully open position.	0.0	999.9	30.0
<i>OP.Lo</i>	<i>OP.Lo</i> is the low output power limit.	- 100.0	100.0	- 100.0
<i>OP.Hi</i>	<i>OP.Hi</i> is the High output power limit	- 100.0	100.0	100.0
<i>OnT.H</i>	Output pulse minimum on time, in seconds.	<i>Auto</i>	999.9	0.2

Table 8-1 Motorised valve parameter list

8.2. COMMISSIONING THE MOTORISED VALVE CONTROLLER

Proceed as follows:

1. Measure the time taken for the valve to be raised from its fully closed to its fully open position and enter this as the value in seconds into the '*mTr*' parameter.
2. Set all the other parameters to the default values shown in Table 8-1.

The controller can then be tuned using the automatic or manual tuning techniques.

8.2.1. Adjusting the minimum on-time '*OnT.H*'

The default value of 0.2 seconds is satisfactory for most processes. The minimum on time determines how accurately the valve can be positioned. The shorter the time, the more precise the control. However, if the time is set too short, process noise will cause an excessively busy valve.

8.3. MOTORISED VALVE APPLICATIONS

8.3.1. Auto Tuning

Before the auto tune is activated, the **Ed** parameter must be set to a numeric value. The **Ed** parameter cannot be set to **OFF** when an auto tune is activated. When the auto tune is complete, the auto tune will set the **Ed** parameter back to the **OFF** position.

8.3.2. Valve Positioner Set-up Table

Name	Description	Value
ConF	Configuration Mode	
Ctrl	In the Inst configuration list set the Ctrl to uP .	uP
1A	Module 1A id needs to be a RELY or a SSF . The Func for 1A should be configured for HEAT . (Open Valve)	HEAT
2A	Module 2A id needs to be a RELY or a SSF . The Func for 2A should be configured for COOL . (Close Valve)	COOL
OPER	Operating Mode (OP List)	
mtc	Valve travel time in seconds. This is the time taken for the valve to travel from its fully closed position to its fully open position.	30.0
OPLo	Low output power limit.	-100.0
OPHi	High output power limit	100.0
OnEt	Output pulse minimum on-time, in seconds.	0.2
OPER	Home List	
UPOS	Calculated position of valve	% of motor travel time

Table 8-2 Valve Positioner Set-up Table



The following operating parameters do not effect the 2200e when the valve positioner option has been configured:

- CHC** Heat Cycle Time
- CLC** Cool Cycle Time
- OnEt** Minimum on time for cooling

Chapter 9 LOAD CURRENT MONITORING AND DIAGNOSTICS

- 9.1 LOAD CURRENT MONITORING AND DIAGNOSTICS2**
- 9.2 EXAMPLE WIRING DIAGRAM (MODE 1 & 2 OPERATION)3**
- 9.3 OPERATION4**
 - To Read Load Current (mode 2 only).....4
 - 9.3.2 To Display Load Current Continuously in the Lower Readout (mode 2 only) 4
 - 9.3.3 Display Modes4
 - 9.3.4 How Heater Alarms Are Displayed5
- 9.4 TO SET THE ALARM TRIP LEVELS6**
- 9.5 RELAY OUTPUTS6**
- 9.6 TO CONFIGURE PDS LOAD CURRENT DIAGNOSTICS.....7**
 - 9.6.1 To Configure the Logic Module for PDS modes 1 or 2.....7
 - To Configure Low and High Current Trip Alarms8
 - 9.6.3 To Attach Soft Alarms To A Relay Output9
 - 9.6.4 The Scaling Factor10
 - 9.6.5 To Adjust The Scaling Factor10

9.1 LOAD CURRENT MONITORING AND DIAGNOSTICS

Current flowing in a system of electrical heating elements (the 'Load') can be displayed on the controller by using a TE10 SSR fitted with intelligent current transformer, PDCTX, or an SSR or contactor with an external PDCTX.

Load current monitoring and diagnostics may be used with any time proportioned output, fitted in module position 1A, and uses the logic output wires which drive the SSR to return signals back to the controller. These signals represent the RMS value of the load current during the ON period, or load related alarm conditions. It is not designed for analogue outputs i.e. phase angle control.

It is also designed for single phase operation only.

There are two modes of operation:-

1. Mode 1

Detects if there is a **break in the heater circuit**. This includes heater or SSR open circuit. A single **Load Failure** alarm message is displayed on the lower readout of the controller.

2. Mode 2

Provides the following:-

Display of true RMS load current On the lower readout of the controller	Displays the true RMS current in the ON state to the load.
Low current alarm Analogous to Partial Load Failure (PLF) supplied in some SSRs	Provides advanced warning of failure of one or more heaters in parallel
High current alarm Activated when the heater exceeds a set limit	Typically used where element bunching may occur
SSR short circuit	This will apply full power to the heaters which could result in an over temperature condition. This alarm provides early warning.
Heater failure	Indicates open circuit load conditions

9.2 EXAMPLE WIRING DIAGRAM (MODE 1 & 2 OPERATION)

Hardware Required

1. SSR type **TE10/PDS2** OR
2. Intelligent current transformer type **PD/CTX** + **contactor or zero voltage switching SSR** 2216e controller configured for PDS mode 2 option using logic output. This module must be fitted in module position 1. (order code **M2**).

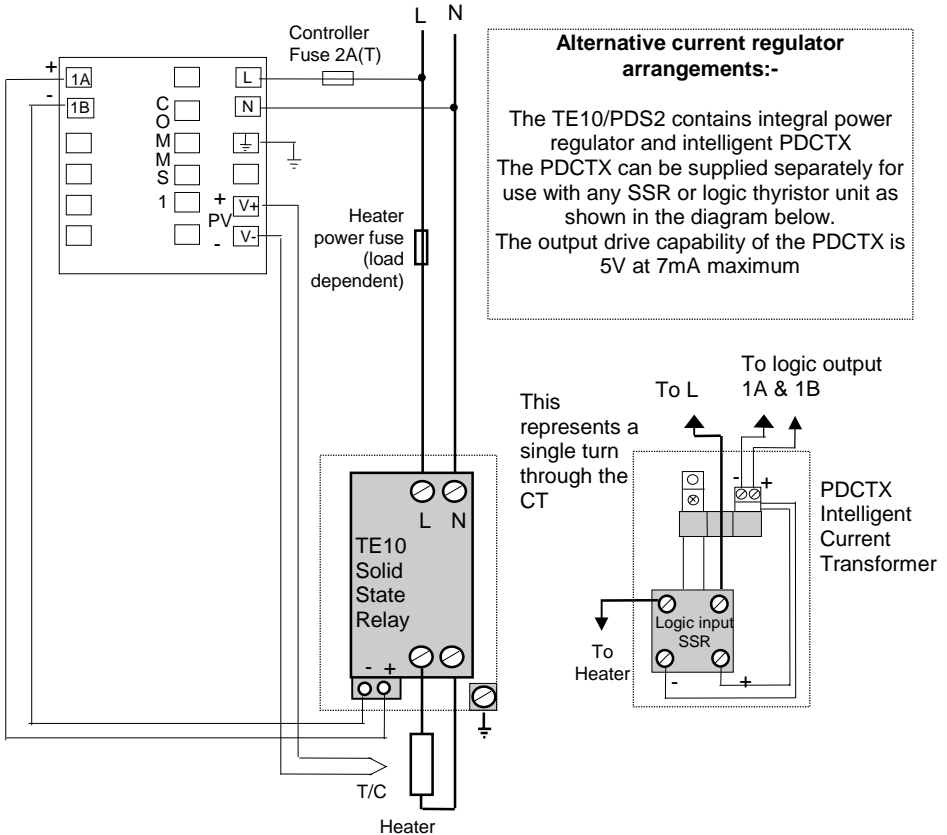

Figure 9.1 Connections for Mode 1 & 2



WARNING!





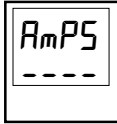

Take care that the controller is correctly wired for the mode of operation which is configured. Failure to do so may be hazardous in some situations.

9.3 OPERATION

9.3.1 To Read Load Current (mode 2 only)

Do This	This Is The Display You Should See	Additional Notes
<p>From the 'HOME' display, Figure 1.4,</p> <p>Press  until <i>AmPS</i> is shown in the upper display</p>	 <p>Current will be displayed in the lower readout. See also 'Display Modes' below.</p>	<p>It will revert to the HOME display after 45 seconds or 10 seconds if an alarm is present</p>
	 <p>This display will be shown if:</p> <ol style="list-style-type: none"> I. The controller is unable to resolve the reading II. The controller is obtaining a reading III. The measurement has timed out i.e. current has not flowed for 15 seconds. 	

9.3.2 To Display Load Current Continuously in the Lower Readout (mode 2 only)

Do This	This Is The Display You Should See	Additional Notes
<p>From the 'HOME' display, Figure 1.4,</p> <p>Press  until <i>d, SP</i> is shown in the upper display</p> <p>Press  or  until <i>AmPS</i> is displayed in the lower display</p>		<p>Current will be displayed in the lower readout continuously when the controller reverts to the HOME display, see also 'Display Modes' below.</p>

9.3.3 Display Modes

SSR RMS On State Current

This is the default state when high or low current alarms are configured. The load current displayed is the steady state true rms current measured during the ON period.

The minimum on time is:-

Mode 2 0.1second



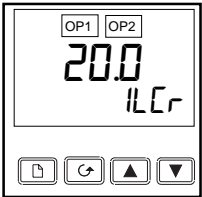

9.3.4 How Heater Alarms Are Displayed

Do This	This Is The Display You Should See	Additional Notes
<p>If an alarm is present it will flash a four character mnemonic in the lower display</p>	<p>Actual Temperature (PV) →</p>  <p>The image shows a digital display with 'HOME Display' at the top. Below it are two small boxes labeled 'OP1' and 'OP2'. The main display shows '20.0' in large digits and '1Lr' in smaller digits below it. At the bottom of the display are four icons: a square with a diagonal line, a circular arrow, an upward-pointing triangle, and a downward-pointing triangle.</p>	<p>If more than one alarm is active, the display will alternate between the alarm messages and the default parameter in the lower display</p>

The Alarm Messages are:-

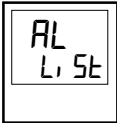
Mnemonic	Meaning	Description
<p>The following two messages are alarms which are produced as a result of failure within the process. In place of dashes the alarm number will appear i.e 1, 2, 3, or 4</p>		
-Lr	Alarm number - <u>L</u> ow <u>C</u> urrent	Used for partial load failure detection. To avoid nuisance tripping due to supply voltage variations set to a value at least 15% below the minimum normal operating current
-Hr	Alarm number - <u>H</u> igh <u>C</u> urrent	Used for load overcurrent protection. To avoid nuisance tripping due to supply voltage variations set to a value at least 15% above the maximum normal operating current. Note: This alarm is not intended to provide instantaneous safety protection from short circuit fault conditions
<p>The following message is a diagnostic alarm which appears for mode 1 operation only.</p>		
LdF	<u>L</u> oad <u>F</u> ail	This includes failure of the heater circuit or the SSR
<p>The following two messages are diagnostic alarms produced as a result of failure within the equipment or wiring connections. They appear for mode 2 operation only.</p>		
Hr.F	<u>H</u> eater <u>F</u> ail	No current is being drawn while the controller output demand signal is on
SSr.F	<u>S</u> SR <u>F</u> ail	The load is continuously on while the controller output demand signal is off

9.4 TO SET THE ALARM TRIP LEVELS

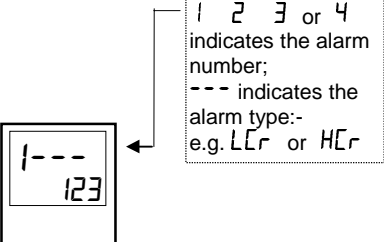
Do This	This Is The Display You Should See	Additional Notes
<p>From the HOME display</p> <p>press  until the AL L, St is displayed</p>		<p>To select the Alarm List header</p>
<p>Press  button</p> <p>until the desired alarm number is displayed</p> <p>Press  or </p> <p>to adjust the alarm trip level</p>	 <p>1 2 3 or 4 indicates the alarm number; --- indicates the alarm type:- e.g. LCr or HCr</p>	<p>To select the diagnostic alarm parameter found under the Alarm List header</p> <p>The alarm trip level is set to 123</p>

9.5 RELAY OUTPUTS

Any plug in module can be used for alarms provided they are not already being used for another purpose, such as control. Any one or more alarms can be attached to an output, which will operate when an alarm occurs. Contacts are rated at 2A 264Vac for operating external beacons or audible devices.









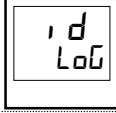

9.6 TO CONFIGURE PDS LOAD CURRENT DIAGNOSTICS

Configuration of PDS load current diagnostics is in four parts:-

1. Configure the Logic Module for PDS Mode 1 or 2 operation..
2. Configure the Low and High Current trip alarms.
3. Attach the alarms to operate an output relay.
4. Set up the Scaling Factor.

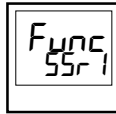
First enter Configuration Level. See Chapter 5



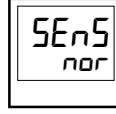







9.6.1 To Configure the Logic Module for PDS modes 1 or 2

Do This	This Is The Display You Should See	Additional Notes
Press  until the 1A CONF is displayed		This opens the configuration list associated with module position 1A
Press  to show 1d		This shows the identity of the module The module identity is <u>logic</u> output
Press  to show Func Press  or  to show 55r 1 or 55r 2 as required.		This shows the <u>function</u> of module The module function is set to PDS mode 1
Press  to show 5En5 Press  or  to show nor		This sets the output signal to normal for heating control

9.6.2 To Configure Low and High Current Trip Alarms

Alarm 1 will be configured as Load Current Low (*LCr*)







Alarm 2 will be configured as Load Current High (*HCr*)

Do This	This Is The Display You Should See	Additional Notes
Press  button until the <i>AL CONF</i> is displayed		This opens the configuration list which contains the Alarms
Press  to show <i>AL 1</i> (alarm 1) Press  or  to show <i>LCr</i>	 <p data-bbox="507 560 699 655">After 0.5 sec the display will blink to show the alarm type has been accepted</p>	<p data-bbox="765 560 932 580">To select alarm 1</p> <p data-bbox="765 628 947 676">To make alarm 1 = <u>L</u>ow <u>C</u>urrent</p>
Press  until <i>AL 2</i> (alarm 2) appears Press  or  to show <i>HCr</i>	 <p data-bbox="507 762 699 858">After 0.5 sec the display will blink to show the alarm type has been accepted</p>	<p data-bbox="765 751 936 772">To select alarm 2.</p> <p data-bbox="765 820 947 868">To make alarm 2 = <u>H</u>igh <u>C</u>urrent</p>



Note:- The above alarms are known as **SOFT ALARMS** because they are indication only.

9.6.3 To Attach Soft Alarms To A Relay Output

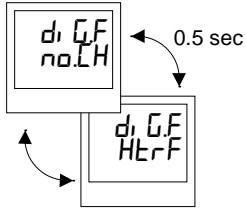
Any one alarm indicated above may be attached to an output (normally a relay). Alternatively any combination of alarms may be attached to operate a relay using the procedure below:-

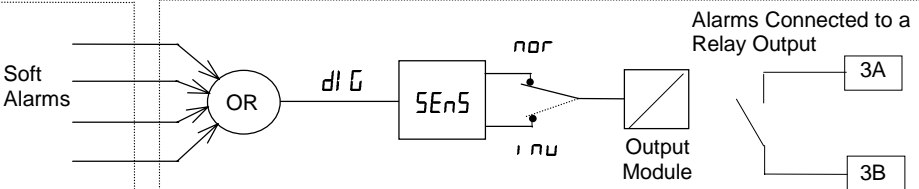
Do This	This Is The Display You Should See	Additional Notes
Press "PAGE" key  as many times as necessary to 3A Conf		Any output module can be configured for an alarm output provided it is not used for any other purpose, eg as a control output. In place of 3A you should select the module required, i.e. 1A or 2A
Press  until d,GF appears		d,GF = digital functions no.ch = <u>no</u> change
Press  or  until the first alarm you wish to attach to the 3A output is displayed e.g. Ht.r.F Repeat the above step for every alarm to be attached to the output		After 0.5 second the display will revert to no.ch to attach the alarm Each time you scroll through the table of alarms note that two decimal points appear. This confirms that the particular alarm has been attached to the output, i.e. Ht.r.F Ss.r.F etc



To remove alarms from an output press  or  until **CLr** appears in the lower display. This will clear all alarms attached to this output.







9.6.4 The Scaling Factor

The value of the current displayed on the controller is scaled using the scaling factor. This is found in the `1 nSt Conf` list. It is set, by default, to 100 and assumes a single turn through the current transformer. If two turns are made through the current transformer it will be necessary to adjust the scaling factor to 50 to obtain the same reading.

Under normal conditions you should not need to change the scaling factor.

If, however, you wish to change the sensitivity of the current reading, for example, to read very low currents you may need to change the number of turns through the PDCTX and/or adjust the scaling factor to compensate. See ‘**Minimum Resolvable Current**’.

9.6.5 To Adjust The Scaling Factor

Do This	This Is The Display You Should See	Additional Notes
Press  button until <code>1 nSt Conf</code> is displayed		
Press  until <code>LC.Hi</code> is displayed		
Press  or  to change the scaling factor		

Minimum Resolvable Current

TE10 . 4A RMS. It is not possible to read currents lower than 4A when using a TE10.

PDCTX 4A RMS for a single turn through the PDCTX

Should you wish to read currents lower than 4A using a PDCTX it is necessary to increase the number of turns through the PDCTX and adjust the scaling factor to compensate.

For example: To read 1.0A wind 4 turns through the PDCTX and adjust the scaling factor to 25 as shown in the table below.

Scalar = 100/N Where N = Turns through PDCTX			
N	Scalar	N	Scalar
1	100	5	20
2	50	10	10
4	25		

Maximum Resolvable Current

TE10 Determined by the maximum range of the SSR

PDCTX 100A (or 100 ampere turns)

Finally Exit configuration level. See Chapter 5

10 Chapter 10 RETRANSMISSION

- 10 Chapter 10 RETRANSMISSION..... 1
- 10.1 WHAT IS RETRANSMISSION.....2
- 10.2 TO CONFIGURE RETRANSMISSION3
- 10.3 SCALING RETRANSMITTED OUTPUT SIGNALS.....4
 - 10.1.1 To Range Retransmitted Output OP 4
 - 10.1.2 To Range Retransmitted Setpoint SP or Process Variable PV 5
 - 10.1.3 To Range Retransmitted Error Err 5

10.1 WHAT IS RETRANSMISSION

The controller can be configured to generate an analogue output signal which represents a selected parameter.

The parameters which can be configured for retransmission are:-

1. Process Variable
2. Setpoint
3. Error
4. Control Output











The retransmission signal is available as 0-20mA, 4-20mA, 0-5V, 1-5V or 0-10V and is connected to terminals 1A and 1B when module 1A is fitted as a DC module.

10.2 TO CONFIGURE RETRANSMISSION

A DC module must be fitted in module position 1A.

First enter configuration level. See Chapter 5.

Then:-

Do This	This Is The Display You Should See	Additional Notes
Press  button until the <i>1A Conf</i> is displayed		This opens the configuration list for module 1A.
Press  to show <i>1d</i>		This is the identity of the module fitted in this position The module must be a DC output <i>dC.OP</i>
Press  to show <i>Func</i> Press  or  to select the parameter for retransmission	 The choices are:- <i>nonE</i> Control Outputs <i>HEAT</i> <i>COOL</i> Retransmission <i>OP</i> <i>PU</i> <i>Err</i> <i>wSP</i>	Output turned off Heat control output Cool control output Output demand Process Variable Error Setpoint (working)
Press  to show <i>SEnS</i>		If <i>Func</i> is a retransmission parameter the value of <i>SEnS</i> has no effect.

Press  to show
OUT.L



The retransmitted output signal can be limited by adjusting these parameters.

Press  to show
OUT.H



To reverse the output, set OUT.L to 20.0 and OUT.H to 0.0.

10.3 SCALING RETRANSMITTED OUTPUT SIGNALS

The analogue output signal may be set between 0 and 20mA. A 4-20mA output is achieved by applying an offset as described below.

A 0 to 10Vdc output may be achieved by fitting a 500 ohm resistor across the output terminals 1A and 1B. A 0 to 5Vdc output may be achieved by fitting a 250 ohm resistor across the output terminals 1A and 1B. Suitable resistors are supplied with the controller.

10.1.1 To Range Retransmitted Output

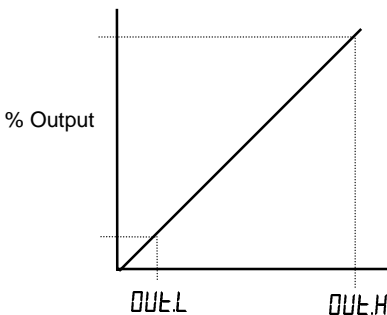

For output of 0-100% = 0-20mA
set OUT.H to 20.0 and OUT.L to 0.0

For output of 0-100% = 4-20mA
set OUT.H to 20.0 and OUT.L to 4.0

10.1.2 To Range Retrasmited Setpoint SP or Process Variable PU

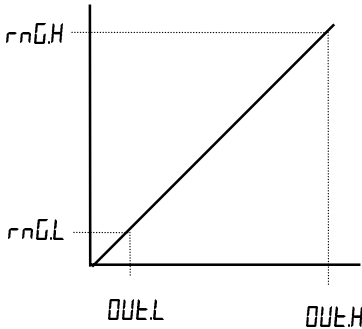

For output of 0 - 1000°C = 0-20mA
 set $OUE.L$ to 0.0 and $OUE.H$ to 20.0
 and $rnG.L$ to 0.0 and $rnG.H$ to 1000

$rnG.L$ is the low limit of the input range
 $rnG.H$ is the high limit of the input range

These are found in the $IPCONF$ list as described in Chapter 5. If the range limits are not set the retransmitted output is the maximum input range as stated in the order code, Appendix A.

10.1.3 To Range Retrasmited Error ERR

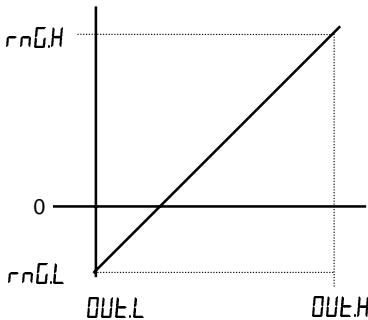

The retransmitted output value is dependent upon the range limits $rnG.H$ and $rnG.L$ set in the $IPCONF$ list of the controller.

The following examples are given to illustrate the retransmitted error values:

Example 1:
 Type K thermocouple,
 $rnG.L = -200$
 $rnG.H = +200$
 Retrasmited Value
 0mA for an error of -200
 10mA for an error of 0
 20mA for an error of +200

Example 2:
 As above but $rnG.L = -10$ and $rnG.H = 400$
 Retrasmited Value
 0mA for an error of -10
 0.0487mA for an error of 0
 20mA for an error of +400

Note:

To read a negative error it is necessary to set $rnG.L$ to a negative limit

A Appendix A UNDERSTANDING THE ORDERING CODE

The 2216e controller has a modular hardware construction with the option of three outputs and one communications port.

The ordering code is in two parts: the hardware code followed by the software code. The hardware code specifies the hardware build of the controller, and the software code the software configuration. The software code is optional.

UK Default	USA Default
Type KTIC 0 to 1000°C	Type JTIC 32 to 2192°F

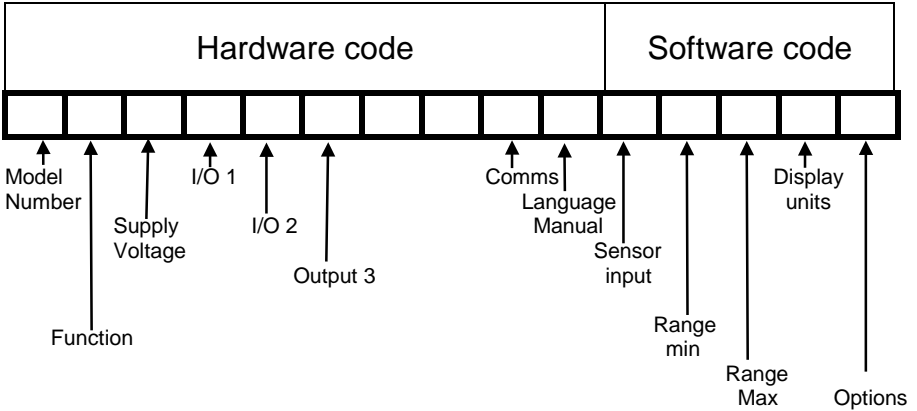

Hardware code

Model number	Function	Supply voltage	Output 1	Input/ Output 2	Output 3	Comms	Manual
2216e	CC	VH	LH	RC	FL	2YM	ENG

Function

CC	Controller
VC	Valve Positioner
NF	On/Off
AL	Alarm Unit

Supply voltage

VH	85-264Vac
----	-----------

Output 1

XX	Not fitted
Relay: 2-pin	
R1	Unconfigured
RU	VP raise O/P
RH	PID heating
FH	High alarm 1
FL	Low alarm 1
DB	Deviation band 1
DL	Dev. low alarm 1
DH	Dev high alarm 1
Logic	
L1	Unconfigured
LH	PID heating
M1	PDS mode 1 note 1
M2	PDS mode 2 note 2
Triac	
T1	Unconfigured
TH	PID heating
TU	VP raise O/P
DC control -isolated	
D3	Unconfigured
H6	0-20mA PID heating
H7	4-20mA PID heating
C6	0-20mA PID cooling
C7	4-20mA PID cooling
DC	Retrans. (isolated)
<i>Select from table A</i>	

Table A

D6	Fitted unconfigured
First character	
V-	PV retrans
S-	Setpoint
O-	Output
Z-	Error
Second character	
-1	0-20mA
-2	4-20mA
-3	0-5V
-4	1-5V
-5	0-10V

Input/Output 2

XX	Not fitted
Relay: 2-pin	
R1	Unconfigured
RH	Heating output
RC	Cooling output
RW	VP lower O/P
FH	High alarm 2
FL	Low alarm 2
DB	Deviation band 2
DL	Dev low. alarm 2
DH	Dev high alarm 2
AL	Hi & Lo alarms 1 & 2
Logic Input	
AM	Auto manual select
S2	Setpoint 2 select
AC	Alarm ack/reset
EH	Integral hold
SB	Standby mode
SR	PDS remote SP select
M5	CTX mode 5 current input
Logic output	
L1	Unconfigured
LC	PID cooling
LH	Heating output
Triac	
T1	Unconfigured
TC	PID cooling
TW	VP lower O/P
TH	Heating output

Manual

XXX	No manual
ENG	English
FRA	French
GER	German
ITA	Italian
NED	Dutch
SPA	Spanish
SWE	Swedish

Output 3

XX	Not fitted
RF	Unconfigured
RH	Heating output
RC	Cooling output
FH	High alarm 3
FL	Low alarm 3
DB	Deviation band 3
DL	Dev. low alarm 3
DH	Dev high alarm 3
AL	High and Low alarms
PDS Alarms	
LF	Heater break
HF	Current monitoring heater break
SF	Current monitoring SSR failure

Comms

2XX	Not fitted
Modbus protocol	
2YM	2-wire RS485
2FM	4-wire RS422
2AM	RS232
EI-Bisynch	
2YE	2-wire RS485
2FE	4-wire RS422
2AE	RS232
DeviceNet	
2DN	DeviceNet
PDS Input	
2RS	Setpoint

Software code

Sensor input	Range min	Range max	Units	Options
K	0 (note 3)	1000 (note 3)	C	CF

Sensor input	Range Min	Range Min		
Standard sensors	Min °C	max	Min °F	max
J J thermocouple	-210	1200	-340	2192
K K thermocouple	-200	1372	-325	2500
T T thermocouple	-200	400	-325	750
L L thermocouple	-200	900	-325	1650
N N thermocouple	-200	1300	-325	2370
R R thermocouple	-50	1768	-58	3200
S S thermocouple	-50	1768	-58	3200
B B thermocouple	0	1820	32	3310
P Platinel II therm'ple	0	1369	32	2496
Z RTD/PT100	-200	850	-325	1562
Factory download input				
C °C thermocouple	0	2319	32	4200
W5%Re/W26%Re (Hoskins)				
D W3%Re/W25%Re	0	2399	32	4350
E E thermocouple	-200	1000	-325	1830
1 Ni/Ni18%Mo	0	1399	32	2550
2 Pt20%Rh/Pt40%Rh	0	1870	32	3398
3 W/W26%Re (Englehard)	0	2000	32	3632
4 W/W26%Re (Hoskins)	0	2010	32	3650
5 W5%Re/W26%Re (Englehard)	10	2300	50	4172
6 W5%Re/W26%Re (Bucose)	0	2000	32	3632
7 Pt10%Rh/Pt40%Rh	-200	1800	392	3272
8 Exergen K80 IR pyrometer	-45	650		
Process inputs				
M -9.99 to +80.00mV	Min		Max	
Y 0 to 20mA	-999		9999	
A 4 to 20ma	-999		9999	
W 0 to 5Vdc	-999		9999	
G 1 to 5Vdc	-999		9999	
V 0 to 10Vdc	-999		9999	

Units	
C	Celsius
F	Fahrenheit
K	Kelvin
X	Linear input

Options	
Control action	
XX	Reverse acting (standard)
DP	Direct acting PID
Power feedback	
XX	Enabled on logic, relay & triac heating outputs
PD	Power feedback disabled
Cooling options	
XX	Linear cooling
CF	Fan cooling
CW	Water cooling

Notes:

1. PDS heater break detect will transmit the power demand to a TE10S solid state relay and read back a heater break alarm.
2. PDS current monitoring will transmit the power demand to a TE10S solid state relay and read back load current and open and short circuit alarms.
3. Setpoint limits: Include the decimal position required in the displayed value – up to one for temperature inputs, up to two for process inputs
4. An external 1% current sense resistor is supplied as standard. If greater accuracy is required, a 0.1% 2.49 Ω can be ordered as part number SUB2K/249R.1.

B Appendix B SAFETY and EMC INFORMATION

This controller is intended for industrial temperature and process control applications when it will meet the requirements of the European Directives on Safety and EMC. Use in other applications, or failure to observe the installation instructions of this handbook may impair safety or EMC. The installer must ensure the safety and EMC of any particular installation.

Safety

This controller complies with the European Low Voltage Directive 73/23/EEC, amended by 93/68/EEC, by the application of the safety standard EN 61010.

Electromagnetic compatibility

This controller conforms with the essential protection requirements of the EMC Directive 89/336/EEC, amended by 93/68/EEC, by the application of a Technical Construction File. This instrument satisfies the general requirements of the industrial environment defined in EN 50081-2 and EN 50082-2. For more information on product compliance refer to the Technical Construction File.

GENERAL

The information contained in this manual is subject to change without notice. While every effort has been made to ensure the accuracy of the information, your supplier shall not be held liable for errors contained herein.

Unpacking and storage

The packaging should contain an instrument mounted in its sleeve, two mounting brackets for panel installation and this operating book. Certain ranges are supplied with an input adapter. If on receipt, the packaging or the instrument are damaged, do not install the product but contact your supplier. If the instrument is to be stored before use, protect from humidity and dust in an ambient temperature range of -30°C to +75°C.

SERVICE AND REPAIR

This controller has no user serviceable parts. Contact your supplier for repair.

Caution: Charged capacitors

Before removing an instrument from its sleeve, disconnect the supply and wait at least two minutes to allow capacitors to discharge. It may be convenient to partially withdraw the instrument from the sleeve, then pause before completing the removal. In any case, avoid touching the exposed electronics of an instrument when withdrawing it from the sleeve. Failure to observe these precautions may cause damage to components of the instrument or some discomfort to the user.

Electrostatic discharge precautions

When the controller is removed from its sleeve, some of the exposed electronic components are vulnerable to damage by electrostatic discharge from someone handling the controller. To avoid this, before handling the unplugged controller discharge yourself to ground.

Cleaning

Do not use water or water based products to clean labels or they will become illegible. Isopropyl alcohol may be used to clean labels. A mild soap solution may be used to clean other exterior surfaces of the product.

INSTALLATION SAFETY REQUIREMENTS

Safety Symbols

Various symbols are used on the instrument, they have the following meaning:

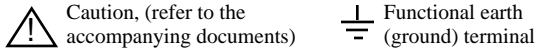

The functional earth connection is not required for safety purposes but is used to ground RFI filters.

Personnel

Installation must only be carried out by qualified personnel.

Enclosure of live parts

To prevent hands or metal tools touching parts that may be electrically live, the controller must be installed in an enclosure.

Caution: Live sensors

The logic and PDS outputs are electrically connected to the main PV input, (thermocouple etc.). If the temperature sensor is connected directly to an electrical heating element then these non-isolated inputs and outputs will also be live. The controller is designed to operate under these conditions. However you must ensure that this will not damage other equipment connected to these inputs and outputs and that service personnel do not touch connections to these I/O while they are live. With a live sensor, all cables, connectors and switches for connecting the sensor and non-isolated inputs and outputs must be mains rated.

Wiring

It is important to connect the controller in accordance with the wiring data given in this handbook. Take particular care not to connect AC supplies to the low voltage sensor input or other low level inputs and outputs. Only use copper conductors for connections, (except thermocouple). Ensure that the wiring of installations comply with all local wiring regulations. For example in the in the UK, use the latest version of the IEE wiring regulations, (BS7671). In the USA, use NEC Class 1 wiring methods.

Power Isolation

The installation must include a power isolating switch or circuit breaker that disconnects all current carrying conductors. The device should be mounted in close proximity to the controller, within easy reach of the operator and marked as the disconnecting device for the instrument.

Earth leakage current

Due to RFI Filtering there is an earth leakage current of less than 0.5mA. This may affect the design of an installation of multiple controllers protected by Residual Current Device, (RCD) or Ground Fault Detector, (GFD) type circuit breakers.

Overcurrent protection

To protect the internal PCB tracking within the controller against excess currents, the AC power supply to the controller and power outputs must be wired through the fuse or circuit breaker specified in the technical specification.

Voltage rating

The maximum continuous voltage applied between any connection to ground must not exceed 264Vac.

The controller should not be wired to a three phase supply with an unearthed star connection. Under fault conditions such a supply could rise above 264Vac with respect to ground and the product would not be safe.

Voltage transients across the power supply connections, and between the power supply and ground, must not exceed 2.5kV. Where occasional voltage transients over 2.5kV are expected or measured, the power installation to both the instrument supply and load circuits should include a transient limiting device.

These units will typically include gas discharge tubes and metal oxide varistors that limit and control voltage transients on the supply line due to lightning strikes or inductive load switching. Devices are available in a range of energy ratings and should be selected to suit conditions at the installation.

Conductive pollution

Electrically conductive pollution must be excluded from the cabinet in which the controller is mounted. For example, carbon dust is a form of electrically conductive pollution. To secure a suitable atmosphere, install an air filter to the air intake of the cabinet. Where condensation is likely, for example at low temperatures, include a thermostatically controlled heater in the cabinet.

Grounding of the temperature sensor shield

In some installations it is common practice to replace the temperature sensor while the controller is still powered up. Under these conditions, as additional protection against electric shock, we recommend that the shield of the temperature sensor is grounded. Do not rely on grounding through the framework of the machine.

Over-temperature protection

When designing any control system it is essential to consider what will happen if any part of the system should fail. In temperature control applications the primary danger is that the heating will remain constantly on. Apart from spoiling the product, this could damage any process machinery being controlled, or even cause a fire.

Reasons why the heating might remain constantly on include:

- the temperature sensor becoming detached from the process
- thermocouple wiring becoming short circuit;
- the controller failing with its heating output constantly on
- an external valve or contactor sticking in the heating condition
- the controller setpoint set too high.

Where damage or injury is possible, we recommend fitting a separate over-temperature protection unit, with an independent temperature sensor, which will isolate the heating circuit.

Please note that the alarm relays within the controller will not give protection under all failure conditions.

INSTALLATION REQUIREMENTS FOR EMC

To ensure compliance with the European EMC directive certain installation precautions are necessary as follows:

- For general guidance refer to EMC Installation Guide, HA025464.
- When using relay or triac outputs it may be necessary to fit a filter suitable for suppressing the conducted emissions. The filter requirements will depend on the type of load. For typical applications we recommend Schaffner FN321 or FN612.
- If the unit is used in table top equipment which is plugged into a standard power socket, then it is likely that compliance to the commercial and light industrial emissions standard is required. In this case to meet the conducted emissions requirement, a suitable mains filter should be installed. We recommend Schaffner types FN321 and FN612.

Routing of wires

To minimise the pick-up of electrical noise, the low voltage DC connections and the sensor input wiring should be routed away from high-current power cables. Where it is impractical to do this, use shielded cables with the shield grounded at both ends. In general keep cable lengths to a minimum.

TECHNICAL SPECIFICATION

Input

General	Range	$\pm 100\text{mV}$ and 0 to 10Vdc (auto ranging)
	Sample rate	9Hz (110mS)
	Calibration accuracy	0.25% of reading, ± 1 LSD, $\pm 1^\circ\text{C}/\text{F}$
	Resolution	$<1\mu\text{V}$ for $\pm 100\text{mV}$ range, $<0.2\text{mV}$ for 10Vdc range
	Linearisation accuracy	$<0.1\%$ of reading
	Input filter	1.0 to 999.9 secs
Thermocouple	Zero offset	User adjustable over the fully display range
	Types	Refer to Sensor inputs and display ranges table
	Cold junction compensation	Automatic compensation typically >30 to 1 rejection of ambient temperature change (incorporates INSTANT ACCURACY™ cold junction sensing technology). External references 32, 113 and 122°F (0, 45 and 50°C)
RTD/PT100	Type	3-wire, Pt100 DIN43760
	Bulb current	0.2mA
Process	Lead compensation	No error for 22 ohms in all 3 leads
	Linear	-9.99 to 80.00mV, 0 to 20mA or 0 to 10Vdc (All configurable between limits)

Outputs

Relay	Rating: 2-pin relay	Min: 12V, 100mA dc Max: 2A, 264Vac resistive
	Rating: change-over, alarm relay	Min: 6V, 1mA dc Max: 2A, 264Vac resistive
Logic	Application	Heating, cooling or alarms
	Rating	18Vdc at 24mA (non-isolated)
	Application	Heating, cooling or alarms PDS mode 1: SSRx Load Doctor™ logic heating with load failure alarm PDS mode 2: SSRx Enhanced Load Doctor™ logic heating with load/SSC failure alarms and load current display
Triac	Rating	1A, 30 to 264Vac resistive
Analog	Application	Heating or cooling
	Range	Isolated, 0 to 20mA 0 to 10Vdc (configurable between limits)
	Application	Heating or cooling

Communications

Digital	Transmission standard	EIA-485 2wire, EIA-422 4 wire or EIA-232 at 1200, 2400, 4800, 9600, 19,200 baud (125K, 250K, 500K for DeviceNet.
PDS	Protocols	Modbus®, EI-Bisynch, DeviceNet
	Setpoint input	Setpoint input from master PDS controller

Control functions

Control	Modes	PID or PI with overshoot inhibition, PD, PI, P only or On/Off
	Application	Heating and cooling
	Auto/manual	Bumpless transfer
	Setpoint rate limit	0.01 to 99.99 degrees or display units per minute
Tuning	Cooling algorithms	Linear; Water (non-linear); Fan (minimum on time), Oil, proportional only
	One-shot tune	Automatic calculation of PID and overshoot inhibition parameters
	Automatic droop compensation	Automatic calculation of manual reset value when using PD control
Alarms	Types	Full scale high or low. Deviation high, low, or band
	Modes	Latching or non-latching. Normal or blocking action Up to four process alarms can be combined onto a single output

General

Display	Dual, 4 digit x 7 segment high intensity LED
Dimensions and weight	1.89W x 1.89H x 4.06D in (48W x 48H x 103Dmm) 8.82oz (250g)
Supply	85 to 264Vac -15%, +10%. 48 to 62Hz. 10watts max
Temperature and RH	Operating: 32 to 131°F (0 to 55°C), RH: 5 to 90% non-condensing. Storage: 14 to 158°F (-10 to 70°C)
Panel sealing	IP 65
Electromagnetic compatibility	Meets generic emissions standard EN50081-2 for industrial environments Meets general requirements of EN50082-2(95) standards for industrial environments
Safety standards	EN61010, installation category 2 (voltage transients must not exceed 2.5kV)
Atmospheres	Electrically conductive pollution must be excluded from the cabinet in which this controller is mounted. This product is not suitable for use above 6,562ft (2000m) or in corrosive or explosive atmospheres without further protection.