

Eurotherm®

Mini8® Controller

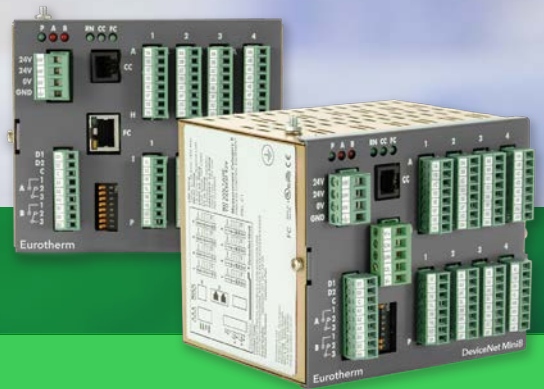

Control, Optimize, Simplify

Unique features

The key features of the Mini8 Controller include:

- 16 control loops
- 32 analog inputs
- Modular & compact
- Setpoint programming
- Math and logic
- Communications protocols
 - Modbus RTU
 - DeviceNet®
 - Profibus DP
 - Modbus TCP
 - EtherNet/IP
 - EtherCAT
- Help defend OEM knowledge and IP with OEM security

Benefits

- Complements your PLC
- World-class control algorithm
- Accurate analog measurement
- Flexible communication options
- Compact modular design
- Reduction in panel real estate
- Can reduce total system costs

eurotherm.com/mini8

Life Is On

Schneider
Electric

Mini8 Controller

The Mini8® Controller offers high performance control usually only found in Eurotherm® panel-mount PID controllers. It is also a very competitive and compact data acquisition device. Its modular design enables its I/O and feature set to be selected to cater for a wide range of applications from simple to complex.

The Mini8 Controller is an ideal partner to a programmable logic controller. Able to multi-drop on either serial, Fieldbus or Ethernet communications, it offers a cost-effective alternative to performing analog measurement or loop control in a PLC. Implementing these functions in the Mini8 Controller helps reduce the cost of a PLC system, relieving it of the burden of performing analog functions, often allowing a lower specification processor to be used.

The Mini8 Controller's feature set is comparable with the Eurotherm 3200 Temperature Controllers including its high performance PID control and Setpoint Programmer (SP) programming functions together with a range of features such as Math, Logic, and Timing blocks.

When used in a data acquisition installation the controller's high density analog I/O can be combined with the Eurotherm 6000 Series paperless graphic recorder.

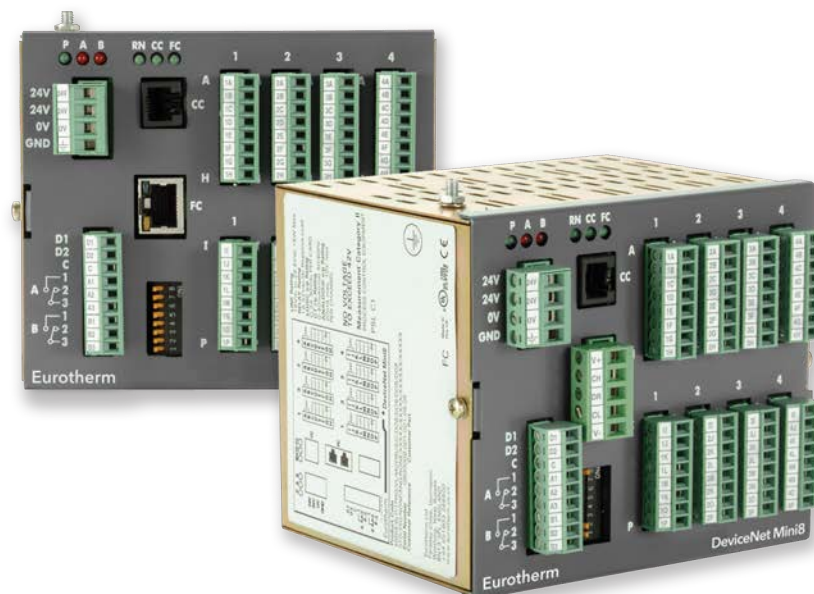

Setpoint Programming

The Mini8 Controller can run up to 8 programmer function blocks, to follow a user-defined series of ramp and dwell segments. Each programmer is capable of running a program of up to 16 segments with 8 event outputs. The event outputs can be used internally within the configuration software or to external digital or relay outputs. (Note: this depends on the type and number of the hardware outputs fitted).

Recipes

Using a PC tool, recipes can be created that can be used to change the operating parameters of the Mini8 Controller simply by selecting a new recipe via a remote HMI. This is very useful where multiple processes use the same controller but require different control parameters.

Heater Failure Detection

The Mini8 Controller with a 3-input current transformer (CT3) card fitted has the capability of detecting failures in heater loads connected to its time proportioned outputs. By measuring the current flowing through the heaters via 3 current transformer inputs the Mini8 Controller can, for up to 8 loops, detect Partial Load failure, Over Current, as well as SSR short or open circuit. Individual load current parameters indicate the measurement for each heater. The current monitor block utilizes a cyclic algorithm to measure the current flowing through one heater per measurement interval.

Toolkit Blocks

A range of toolkit functions, including Math, Logic, and Timing blocks can be used to create custom solutions and small machine controllers.

Eurotherm iTools Graphical Wiring Editor (GWE)

The GWE is an extremely easy way to create applications. It allows users to select the function blocks they wish to use in their application, then connect them together using 'Soft Wiring'. The GWE gives the user a pictorial view of exactly what he has configured and can also be used to monitor runtime conditions.

OEM Security

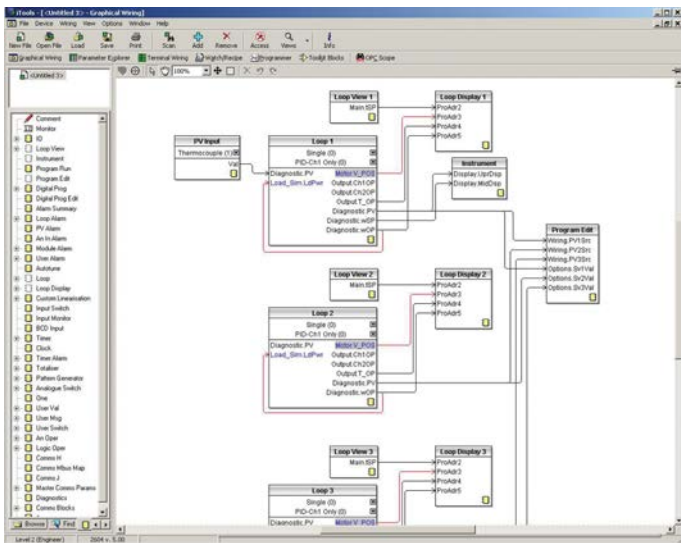

An OEM or reseller can help protect their intellectual property from unauthorized cloning of the application.

Specification

General

Environmental Performance

Power supply voltage:	17.8 V dc min to 28.8 V dc max.
Supply ripple:	2 Vp-p max.
Power consumption:	15 W max.
Operation temperature:	0 to 55°C (32°F to 131°F)
Storage temperature:	-10 to 70°C (14°F to 158°F)
Operating humidity:	5% to 95% RH non-condensing
Applied voltage any terminal:	42 V pk max.

The Mini8 Controller must be mounted in a protective enclosure.

Electromagnetic Compatibility (EMC)

EMC:	EN 61326-1 for Industrial Environments
------	--

This controller conforms with the essential protection requirements of the EMC Directive 2014/30/EU, by the application of EMC standard EN 61326-1. This instrument satisfies the general requirements of the industrial environment defined in EN 61326-1.

Electrical Safety

Safety:	Meets EN 61010-1, installation category II, pollution degree 2
---------	--

INSTALLATION CATEGORY II

This controller complies with the European Low Voltage Directive 2014/35/EU, by the application of the safety standard EN 61010-1.

POLLUTION DEGREE 2

Normally, only non-conductive pollution occurs. Occasionally, however, a temporary conductivity caused by condensation shall be expected.

Physical

Dimensions:	W 124 x H 108 x D 115mm
Weight:	1 kg typical
Mounting:	DIN rail to EN 50022 35 x 7.5 or 35 x 15 horizontally

Approvals

Environmental:	CE, KC, EAC, UL/cUL Listed (file E57766) Green Premium
----------------	---

Communications

Network Communications Support

Modbus RTU:	EIA485, 2 x RJ45, user select switch for 3-wire or 5-wire
Baud rates:	4800, 9600, 19200
DeviceNet:	CAN, 5-pin standard "open connector" with screw terminals
Baud rates:	125k, 250k, 500k
Profibus DP:	EIA485 via standard 9 pin D connector or 2 RJ45 connectors
Data rates:	Up to 12 M set by the Master
Ethernet:	Standard Ethernet RJ45 connector
Data rates:	10baseT
EtherNet/IP:	Standard Ethernet RJ45 connector
Data rates:	10baseT 100baseT
EtherCAT:	Standard Ethernet RJ45 connector
Data rates:	10baseT 100baseT

Modbus/DeviceNet/Profibus/Ethernet/EtherNet/IP/EtherCAT are mutually exclusive options; refer to the Mini8 Controller Order Code.

Configuration Communications Support

Modbus RTU:	EIA485, 2 x RJ45, user select switch for 3-wire or 5-wire
-------------	---

Fixed I/O Resources

The PSU card supports 2 independent and isolated relay contacts.

Relay output types:	On/Off (C/O contacts, "On" closing the N/O pair)
Contact current:	<1 A (resistive loads)
Terminal voltage:	<42 V pk.
Contact material:	Gold
Snubbers:	Snubber networks are NOT fitted
Contact isolation:	42 V pk max.

The PSU card supports 2 independent and isolated logic inputs

Input types:	Logic (24 V dc)
Input logic 0 (off):	-28.8 V to +5 V dc
Input logic 1 (on):	+10.8 V to +28.8 V dc
Input current:	2.5 mA (approx.) at 10.8 V; 10 mA max at 28.8 V supply
Detectable pulse width:	110 ms min.
Isolation to system:	Isolation to system: 42 V pk max.

Input/Output Cards

TC8 8-Channel, ET8 8-Channel and TC4 4-Channel TC Input Card

The TC8 and ET8 support 8 independently programmable and electrically isolated channels, supporting all standard and custom thermocouple types. The TC4 supports 4 channels to the same specification.

Channel types:	TC, mV
Input Range:	-77 mV to +77 mV
Resolution:	20 bit ($\Sigma\Delta$ converter), 1.6 μ V with 1.6 s filter time
Temperature coefficient:	< ± 50 ppm (0.005%) of reading/°C (TC4/TC8) < $\pm 1\mu$ V/C ± 25 ppm/C of measurement, from 25°C ambient (ET8)
Cold junction range:	-10°C to +70°C (14°F to 158°F)
CJ rejection:	> 30:1 (TC4/TC8) 100:1 (ET8)
CJ accuracy:	$\pm 1^\circ$ C (TC4/TC8) $\pm 0.25^\circ$ C (ET8)
Linearization types:	C, J, K, L, R, B, N, T, S, LINEAR mV, custom
Total accuracy:	$\pm 1^\circ$ C $\pm 0.1\%$ of reading (using internal CJC) (TC4/TC8) $\pm 0.25^\circ$ C $\pm 0.05\%$ of reading at 25°C ambient (ET8)
Channel PV filter:	0.0 seconds (off) to 999.9 seconds, 1st order low-pass
Sensor Break:	AC Detector Off, Low or High resistance.
Input resistance:	Trip levels >100Mohms
Input leakage current:	<100 nA (1 nA typical)
Common mode rejection:	>120 dB, 47 – 63 Hz
Series mode rejection:	>60 dB, 47 – 63 Hz
Isolation (channel-channel):	42 V pk max
Isolation to system:	42 V pk max

DO8 8-Channel Digital Output Card

The DO8 supports 8 independently programmable channels, the output switches requiring external power supply. Each channel is current and temperature protected, foldback limiting occurring at about 100 mA.

The supply line is protected to limit total card current to 200 mA.

The 8 channels are isolated from the system (but not from each other). To maintain isolation it is essential to use an independent and isolated PSU.

Channel types:	On/Off, Time Proportioned
Channel supply (V cs):	15 V dc to 30 V dc
Logic 1 voltage output:	> (V cs – 3 V) (not in power limiting)
Logic 0 voltage output:	< 1.2 V dc no-load, 0.9 V typical
Logic 1 current output:	100 mA max. (not in power limiting)
Min. pulse time:	20 ms
Channel power limiting:	Current limiting capable of driving shortcircuit load
Terminal supply protection:	Card supply is protected by 200 mA selfhealing fuse
Isolation (channel-channel):	N/A (Channels share common connections)
Isolation to system:	42 V pk max.

RL8 8-Channel Relay Output Card

The RL8 supports 8 independently programmable channels. This module may only be fitted in slot 2 or 3, giving a maximum of 16 relays in a Mini8 Controller.

The Mini8 Controller chassis must be earthed (grounded) using the Protective Earth stud.

Channel types:	On/Off, Time Proportioned
Maximum contact voltage:	264 V ac
Maximum contact current:	2 A ac
Contact snubber:	Fitted on module
Minimum contact wetting:	5 V dc, 10 mA
Min. pulse time:	220 ms
Isolation (channel-channel):	264 V max, 230 V nominal
Isolation to system:	264 V max, 230 V nominal

CT3 3-Channel Current-Transformer Input Card

The CT3 supports 3 independent channels designed for heater current monitoring. A scan block allows periodic testing of nominated outputs to detect load changes (failure).

Channel types:	A (current)
Factory set accuracy:	Better than $\pm 2\%$ of range
Current input range:	0 mA to 50 mA rms, 50/60 Hz nominal
Transformer ratio:	10/0.05 to 1000/0.05
Input load burden:	1 W
Isolation:	None (provided by CT)

Load Failure Detection

Requires CT3 module.	
Max number of loads:	16 Time Proportioned Outputs
Max loads per CT:	6 loads per CT input
Alarms:	1 in 8 Partial load failure, Over current, SSR short circuit, SSR open circuit
Commissioning:	Automatic or manual
Measurement interval:	1 sec – 60 sec

DI8 8-Channel Logic Input Card

The DI8 supports 8 independent input channels.

Input types:	Logic (24 V dc)
Input logic 0 (off):	-28.8 V to +5 V dc
Input logic 1 (on):	+10.8 V to +28.8 V dc
Input current:	2.5 mA (approx.) at 10.8 V; 10 mA max at 28.8 V supply
Detectable pulse width:	110 ms min.
Isolation (channel-channel):	42 V pk max.
Isolation to system:	42 V pk max.

RT4 Resistance Thermometer Input Card (Pt100)

The RT4 supports 4 independently programmable and electrically isolated resistance input channels. Each channel may be connected as 2 wire, 3 wire, or 4 wire.

Channel types:	Resistance/Pt100
Input range:	0 to 420 ohms, -242.02° C to +850° C for Pt100 (403.6°F to 1562°F)
Calibration error:	± 0.1 ohms $\pm 0.1\%$ of reading, 22 to 420 ohms $\pm 0.3^\circ$ C $\pm 0.1\%$ of reading, -200° C to +850° C (-328°F to 1562°F)
Resolution:	0.008 ohms, 0.02° C (32.036°F)
Measurement noise:	0.016 ohms, 0.04° C (32.072°F) peak to peak, 1.6 s channel filter 0.06 ohms, 0.15° C peak to peak, no filter
Linearity error:	± 0.02 ohms, $\pm 0.05^\circ$ C (32.09°F)
Temp coefficient:	$\pm 0.002\%$ of ohms reading per °C ambient change relative to normal ambient 25° C (77°F)
Lead resistance:	22 ohms max in each leg. Total resistance including leads is restricted to the 420 ohm maximum limit. 3 wire connection assumed matched leads.
Bulb current:	300 μ A
Isolation (channel-channel):	42 V pk max
Isolation to system:	42 V pk max

RT4 Resistance Thermometer Input Card (Pt1000)

The RT4 supports 4 independently programmable and electrically isolated resistance input channels. Each channel may be connected as 2 wire, 3 wire or 4 wire.

Channel types:	Resistance/Pt1000
Input range:	0 to 4200 ohms, -242.02° C to +850° C for Pt1000 (403.6°F to 1562°F)
Calibration error:	± 0.6 ohms $\pm 0.1\%$ of reading, 220 to 4200 ohms $\pm 0.2^\circ$ C $\pm 0.1\%$ of reading, -200° C to +850° C (-328°F to 1562°F)
Resolution:	0.6 ohms, 0.15° C (32.27°F)
Measurement noise:	0.2 ohms, 0.05° C (32.09°F) peak to peak, 1.6 s channel filter 0.6 ohms, 0.15° C (32.27°F) peak to peak, no filter
Linearity error:	± 0.2 ohms, $\pm 0.05^\circ$ C (32.09°F)
Temp coefficient:	$\pm 0.002\%$ of ohms reading per °C ambient change relative to normal ambient 25° C (77°F)
Lead resistance:	22 ohms max in each leg. Total resistance including leads is restricted to the 4200 ohm maximum limit. 3 wire connection assumed matched leads.
Bulb current:	300 μ A
Isolation (channel-channel):	42 V pk max
Isolation to system:	42 V pk max

AO8 8-Channel and AO4 4-Channel 4-20 mA Output Card

The AO8 supports 8 independently programmable and electrically isolated mA output channels for 4-20 mA current-loop applications. The AO4 supports 4 channels to the same specification. The AO4 and AO8 modules may only be fitted in slot 4.

Channel types:	mA (current) Output
Output range:	0-20 mA, 360 ohms load max.
Setting accuracy:	$\pm 0.5\%$ of reading
Resolution:	1 part in 10000 (1 μ A typical)
Isolation (channel-channel):	42 V pk max.
Isolation to system:	42 V pk max.

Software Features

Toolkit Blocks

User wires:		Orderable options of 30, 60, 120 or 250
User values:		32 real values
2 input math:	24 blocks	Add, subtract, multiply, divide, absolute difference, maximum, minimum, hot swap, sample and hold, power, square root, Log, Ln, exponential, switch
2 input logic:	24 blocks	AND, OR, XOR, latch, equal, not equal, greater than, less than, greater than or equal to, less than or equal to
8 input logic:	4 blocks	AND, OR, XOR
8 input multiple operator:	4 blocks	Maximum, Minimum, Average. Input/Outputs to allow cascading of blocks
8 input multiplexer:	4 blocks	8 sets of 8 values selected by input parameter
BCD input:	2 blocks	2 decades (8 inputs giving 0 to 99)
Input monitor:	2 blocks	Max, min, time above threshold
16 point linearization:	2 blocks	16-point linearization fit
Polynomial fit:	2 blocks	Characterization by poly fit table
Switchover:	1 block	Smooth transition between two input values
Timer blocks:	8 blocks	OnPulse, OnDelay, OneShot, MinOn Time
Counter blocks:	2 blocks	Up or down, Directional flag
Totalizer blocks:	2 blocks	Alarm at Threshold value
Real time clock:	1 block	Day & time, 2 time based alarms
Transducer scaling:	2 blocks	Transducer Auto-tare, calibration & comparison cal

PID Control Loop Blocks

Number of Loops:	0, 4, 8 or 16 Loops (order options)
Control modes:	On/Off, single PID, Dual channel OP
Control outputs:	Analog 4-20 mA, Time proportioned logic
Cooling algorithms:	Linear, water, fan, or oil
Tuning:	3 sets PID, One-shot auto-tune
Auto manual control:	Bumpless transfer or forced manual output available
Setpoint rate limit:	Ramp in units per sec, per min or per hour
Output rate limit:	Ramp in % change per second
Other features:	Feedforward, Input track, Sensor break OP, Loop break alarm, remote SP, 2 internal loop setpoints

Process Alarms

Number of alarms:	32 analog, 32 digital, 32 Sensor break
Alarm types:	Absolute high, absolute low, deviation high, deviation low, deviation band, sensor break, logic high, logic low, rising edge, falling edge, edge
Alarm modes:	Latching or non-latching, blocking, time delay

Setpoint Programmer

The Setpoint Programmer is a software orderable option.

Number of programs:	8
Number of segments:	128
Number of event outputs:	8 per program (64 total)
Digital inputs:	Run, Hold, Reset, Run/Hold, Run/Reset, Program Advance, Skip, Segment, Sync
Power failure action:	Ramp, Reset, Continue
Servo start:	PV, SP

Recipes

Recipes are a software orderable option.

Number of recipes:	8
Tags:	24 tags in total

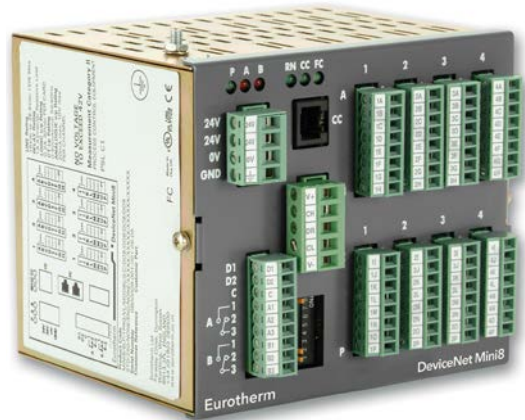

Mechanical Details

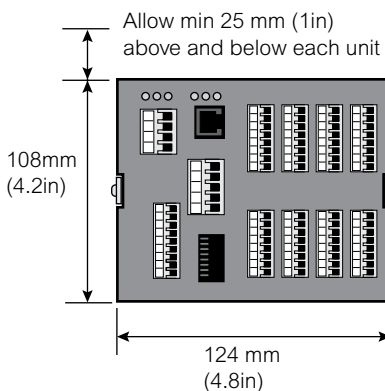

Allow a minimum of 25mm (1in) for terminals and cables in front of the unit.

If the protective cover used with ET8 modules is fitted, allow 31mm (1.22in).

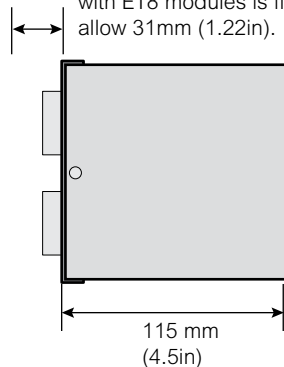

Mounting Information

The Mini8 Controller is intended to be horizontally mounted on symmetrical DIN Rail to EN 55022-35 or 35 x 35 x 15

Protective Cover

When ET8 modules are fitted, also fit the clear protective cover to enhance thermal stability. The figure here shows the cover in place. The cover can be mounted either way up.



Communications Interface LEDs

Legend	Color	Function	Action	
RN	Green	Run mode	On - Running Blinking - Standby/Config Off - Not Running	
CC	Green	Configuration activity	On - N/A Blinking - Config Traffic Off - N/A	
FC	Green	Field comms activity	On - Connected Blinking - Ready Off - Offline	Not applicable to Enhanced DeviceNet and EtherCAT
			Off - No traffic or offline Blinking - Comms Traffic	Modbus, Profibus, EtherNet
NET	Bi-Col	Network status Enhanced DeviceNet and EtherNet/IP	Off - Offline Blinking Green - Online but no connections On Green - Online with connections Blinking Red - Connection timed out On Red - Total connection loss Blinking Red/Green - Issue with Comms detected	
MOD	Bi-Col	Module status Enhanced DeviceNet and EtherNet/IP	Off - Power not supplied to network On Green - DeviceNet interface operational On Red - Power not supplied to controller or incorrect Checksum Blinking Red/Off - Recoverable fault detected. Comms. loss between network and DeviceNet interface. Blinking Red/Green - Power-up tests, unable to enter cyclic states or invalid Baud rate	

LEDs

Legend	Color	Function	Action
P	Green	Indicates Power status	On — Power On Off — Power Off
A	Red	Indicates Relay A state	On — Energized Off — De-Energized
B	Red	Indicates Relay B state	On — Energized Off — De-Energized

RL8 Relay Output

(slots 2 and/or 3 only)

Contact voltage/current — 264 V ac/ 2 A RMS max.

ISOLATION (264 V ac Basic)

- Channel to Channel: 264 V ac Basic
- Channel to system: Reinforced

Note:
Protective earth conductor MUST be used if RL8 module is fitted.

Legend	Function
A	RLY1 A
B	RLY1 B
C	RLY2 A
D	RLY2 B
E	RLY3 A
F	RLY3 B
G	RLY4 A
H	RLY4 B
I	RLY5 A
J	RLY5 B
K	RLY6 A
L	RLY6 B
M	RLY7 A
N	RLY7 B
O	RLY8 A
P	RLY8 B

AO8/A04 Analog Output

(slot 4 only)

Output current — 0 to 20 mA
360 ohm max. load.

ISOLATION

- Channel to Channel: 42 V pk.
- Channel to system: 42 V pk.

Note:
AO4 supports Channels 1 to 4 only.

Legend	Function
A	OP1+
B	OP1-
C	OP2+
D	OP2-
E	OP3+
F	OP3-
G	OP4+
H	OP4-
I	OP5+
J	OP5-
K	OP6+
L	OP6-
M	OP7+
N	OP7-
O	OP8+
P	OP8-

Power Supply

Legend	Supply
24 V	24 V dc
24 V	24 V dc
0 V	0 V
GND	Ground

This terminal can accept wire sizes 0.2 – 2.5 mm (24 – 12 AWG).

Power Supply Specification
Power supply voltage: 17.8 V dc min. to 28.8 V dc max.
Power consumption: 15 W max.

Standard I/O Connections

Legend	Function
D1	Digital Input 1
D2	Digital Input 2
C	Digital Input Common
A1	Relay A n/open
A2	Relay A n/closed
A3	Relay A Common
B1	Relay B n/open
B2	Relay B n/closed
B3	Relay B Common

Note:
Digital Inputs: ON requires greater than 10.8 V with 2 mA drive, 30 V max.
Contacts: 1 A max., 42 V dc max.

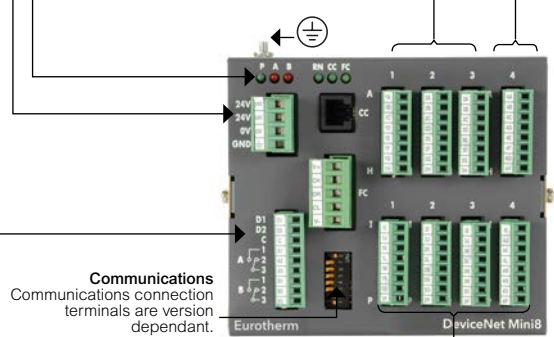

ET8/TC8/TC4 Thermocouple Input

Isolation
• Channel to Channel: 42 V pk.
• Channel to system: 42 V pk.

Note:
TC4 supports Channels 1 to 4 only.

Legend	Function
A	TC1+
B	TC1-
C	TC2+
D	TC2-
E	TC3+
F	TC3-
G	TC4+
H	TC4-
I	TC5+
J	TC5-
K	TC6+
L	TC6-
M	TC7+
N	TC7-
O	TC8+
P	TC8-

RT4 2, 3, 4 Wire RTD Input

Isolation
• Channel to Channel: 42 V pk.
• Channel to system: 42 V pk.

Legend	Function
A	CH1 I+
B	CH1 S+
C	CH1 S-
D	CH1 I-
E	CH2 I+
F	CH2 S+
G	CH2 S-
H	CH2 I-
I	CH3 I+
J	CH3 S+
K	CH3 S-
L	CH3 I-
M	CH4 I+
N	CH4 S+
O	CH4 S-
P	CH4 I-

DI8 Logic Input

Isolation
• Channel to Channel: 42 V pk.
• Channel to system: 42 V pk.

Note:
Input specification as for Standard I/O above.

Legend	Function
A	D1+
B	D1-
C	D2+
D	D2-
E	D3+
F	D3-
G	D4+
H	D4-
I	D5+
J	D5-
K	D6+
L	D6-
M	D7+
N	D7-
O	D8+
P	D8-

CT3 Transformer Input

Isolation
• Channel to Channel: N/A
• Channel to system: N/A

Note:
Isolation provided by current transformers.

Legend	Function
A	NA
B	NA
C	NA
D	NA
E	NA
F	NA
G	NA
H	NA
I	In1 A
J	In1 B
K	No connection
L	In2 A
M	In2 B
N	No connection
O	In3 A
P	In3 b

DO8 Logic Output

Isolation
• Channel to Channel: N/A
• Channel to system: 42 V peak with independent supply

Note:
Requires 24 V dc supply.
* Linked internally.

Legend	Function
A	Supply in +
B	Supply in +
C	OP1+
D	OP2+
E	OP3+
F	OP4+
G	Supply & OP
H	Supply & OP-
I	Supply in +
J	Supply in +
K	No connection
L	In2 A
M	In2 B
N	No connection
O	Supply & OP
P	Supply & OP-

Order Codes

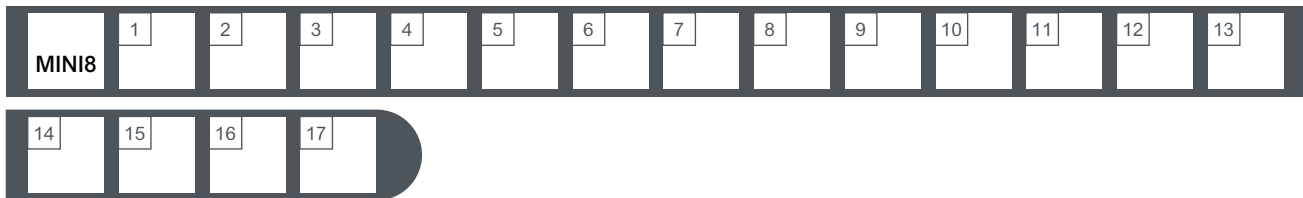

Basic Product	
MINI8	Mini8 Controller

1 Control Loops	
ACQ	IO Acquisition only
4LP	4 Control loops
8LP	8 Control loops
16LP	16 Control loops

2 Programs	
OPRG	No programs
1PRG	1 profile — 50 programs
XPRG	Multi-profiles — 50 programs (Note 1)

3 PSU	
VL	24 V dc

4 Communications	
MODBUS	Non isolated Modbus Slave
ISOLMBUS	Isolated Modbus RTU Slave
DEVICENET	DeviceNet Slave
PBUSRJ45	Profibus Slave RJ45 (Note 2)
PBUS9PIN	Profibus Slave 9 Pin D type (Note 2)
ENETMBUS	Ethernet Modbus TCP/IP Slave
DNETM12	DeviceNet M12 Connector Slave
ENETIP	EtherNet/IP
ETHERCAT	EtherCAT

5 Temperature Units	
C	Centigrade
F	Fahrenheit

6-9 IO Slots 1, 2, 3, 4	
XXX	No module fitted
TC4	4 Ch TC input
TC8	8 Ch TC input
RT4	4 Ch RTD Pt100/Pt1000 input
AO4	4 Ch 4-20 mA O/P (Note 3)
AO8	8 Ch 4-20mA O/P (Note 3)
DO8	8 Ch logic O/P
CT3	3 Ch CT input (Note 4)
RL8	8 Ch relay O/P (Note 5)
DI8	8 Ch logic input
ET8*	Enhanced 8 Ch TC Input (Note 8)

10 Applications	
STD	No configuration
EC8	8 Loop extrusion controller (Note 6) Requires 8LP or 250 wires and modules placed in the following slots Slot 1 = TC8 Slot 2 = CT3 or XXX Slot 3 = DO8 Slot 4 = DO8
FC8	8 Loop furnace controller Requires 8LP or 250 wires and modules placed in the following slots Slot 1 = TC8 Slot 4 = AO8

11 Wires	
30	30 User Wires
60	60 User Wires
120	120 User Wires
250	250 User Wires

12 Recipes	
NONE	No recipes
RCP	8 recipes

13 Manual Language	
ENG	English
FRA	French
GER	German
SPA	Spanish
ITA	Italian

14 Configuration Software	
ENG	English
NONE	No DVD
ITOOOLS	Eurotherm iTools DVD & Mini8 Controller documentation

15 Warranty	
XXXXX	Standard
WL005	Extended

16 Calibration Certificates	
XXXXX	None
CERT1	Certificate of Conformity
CERT2	Factory input calibration per input (Note 7)

17 Specials	
XXXXX	Standard
EU0725	OEM Security

Notes

- If 4 loops ordered 4 programmers are supplied; 8 or 16 loops ordered 8 programmers are supplied.
- Profibus motherboard fitted.
- AO4/AO8 in slot 4 only.
- Only 1 CT3 per Mini8.
- RL8 in slots 2/3 only.
- EC8 is a preconfigured version of Mini8 offering 8 control loops with Heat/Cool logic outputs.
- CERT2 is 5 point calibration.
- Requires firmware V3.01 or higher

Accessories

HA031260	Engneering/DVD manual
SUBMINI8/SHUNT/249R.1	2.49 ohm Precision resistor
RES250	250 ohm resistor for 0-5 V dc OP
RES500	500 ohm resistor for 0-10 V dc OP
CTR100000/000	10 A Current transformer
CTR200000/000	25 A Current transformer
CTR400000/000	50 A Current transformer
CTR500000/000	100 A Current transformer
iTools/None/3000CK	Configuration clip
SUB21/IV10	0-10 V input adaptor

eurotherm.com/mini8

Life Is On

Schneider
Electric

Eurotherm Limited
Faraday Close, Durrington
Worthing, West Sussex, BN13 3PL
Phone: + 44 (0)1903 268500
www.eurotherm.com

Document Number HA028480 Issue 12

©2019 Schneider Electric. All Rights Reserved. Life Is On, Schneider Electric, EcoStruxure, Eurotherm, EurothermSuite, EFit, EPack, EPower, Eycon, Eyris, Chessell, Mini8, nanodac, optivis, piccolo and versadac are trademarks and property of Schneider Electric SE, its subsidiaries and affiliated companies. All other trademarks are the property of their respective owners.

