

KR2S SERIES GRAPHIC RECORDER



KR2S series are advance touch screen display (Keyless) paperless Graphic Recorder with high performance and high operating function along with high visibility 5.7" VGA TFT color LCD display.

Universal input with high speed of sampling rate 100msec and high accuracy rating of $\pm 0.1\%$ realized. Measured data is stored into memory and support up to 8GB through USB and CF card. As it can be monitored by a web browser display on several computers on intranet or internet, FTP transfer of data file and E-mail notification are also available.

FEATURES

- **Employing clear 5.7"VGA TFT color LCD display**
 - Large-sized high visibility display with various display functions. Real time/historical trend screen, circular trend screen, bar-graph screen, data screen are selectable for various applications.
- **Large capacity of data memory and various recording method**
 - USB slot and CF card is equipped as standard memory provided 2GB and optionally expandable up to 8 GB. Various data storing methods are selectable such as schedule programming by time of day and time of date, recording start-up by external signal, and event and data logging of before and after trigger points for alarm.
- **Multi points recording with high speed/accuracy**
 - High-speed recording of approximately 100msec for 4 points and 1 sec for 6/12 points and high accuracy of $\pm 0.1\%$ were realized. Stable measuring and recording are possible with high speed. Withstand voltage between input channels is as high as 1000V AC (Excluding resistance thermometer input).
- **Direct writing on the screen**
 - With attached touch pen, various comments can be written on the screen.
- **Extend inputs with CHINO controllers**
 - KR2S can communicate with up to 16 CHINO controllers for parameter settings and read/record of measuring values through low-order communications (Option).
- **Easy operating and programming without manual**
- **USB port provided in front**
 - Readout of data and files are possible by connecting through an USB memory stick for PC.
- **LAN network capability (Option)**
 - Various networked environment such as remote monitoring by browser, FTP, HTTP, SNMP and DHCP server and E-mail notification are applied when Ethernet communication interface is used.
- **Safety system and reliability**
 - No battery backup needed for recorded storage data.
- **Analyzing/data acquisition application software (Option)**
 - It is easy to replay and edit the recorded data file. Replay display has various mode of vertical/horizontal trend, circular trend and also has wave-analyzing and marking by using the cursor.
- **Custom graphic screen for per each applications (NEW)**
 - By using optional custom graphic screen function, it can display the graphic screen which the user created by PC software KR Screen Designer (option). Create letters, rectangle, oval, line, etc by drawing tool and allocate KR measuring data while making the background by JPEG or other images. By lower communication, controller SV, MV, PID can also be changed. Register up to 5 screens and its screens are switchable.



MODELS

KR2S PS -

Measurement point/sampling rate

- 6: 6 points/1 sec.
- 2: 12 points/1 sec.

Communication interface (option)

- N: None
- E: Ethernet
- R: Low/high order communications (RS485)
- G: Ethernet + low/high order communications (RS485)

Alarm output, Contact input (option)

- 0: None
- 2: Mechanical relay output (4 points 'c' contact)
- 7: Digital input (4 points)
- 8: Mechanical relay output (2 points 'c' contact) + Digital input (2 points)

Installation type

- A: Device mounting (panel mounting type)
- T: Portable type (Grip and rubber feet attached)

Others (option)

- NNN : None
- 1NN : Custom graphic screen

* If the recording cycle is set less than 500ms (100 to 500 ms), input channel point becomes 100ms for 4 points automatically.

KR2S SERIES

SCREENS

Sharp touch panel display based on Human Engineering such as color, line, thickness, key position. Adopts VGA (640X480) which has 4 times better resolution of conventional model.

Data screen

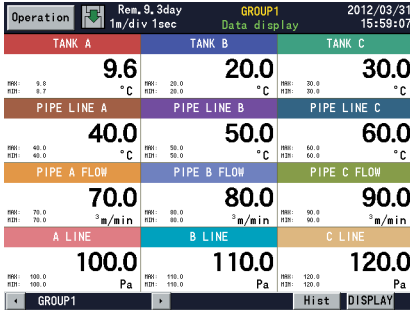

Bar-graph screen

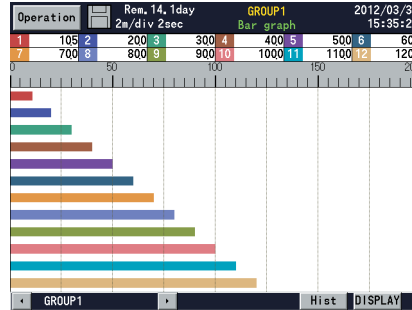

Real-time trend screen

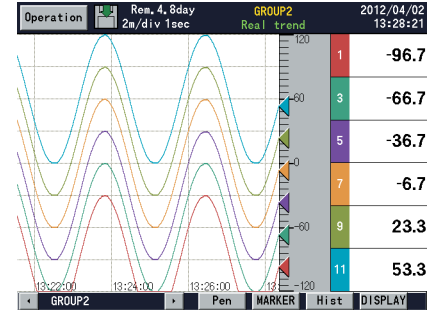

Graphic screen

Enable to create custom display for each user*.

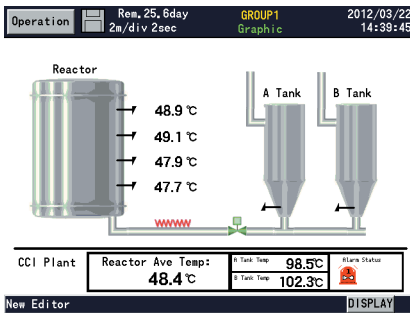

Pen writing

Free writing by 16 colors.

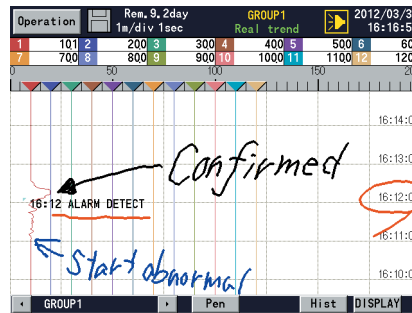

Circular trend screen

High-resolution color and easy to read curve.

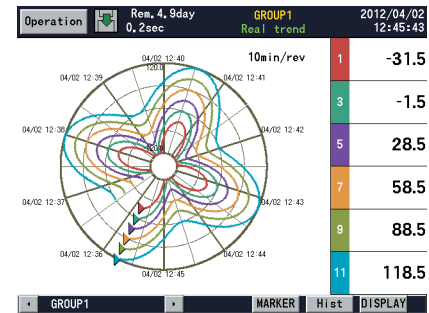

2-Zone screen

Split the trend in 2-zones and monitor.

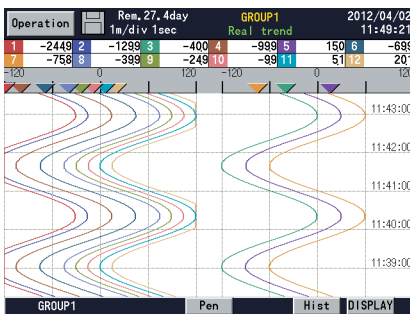

Dual trend screen

2 split display for real time trend and historical trend. Scroll available for historical trend.

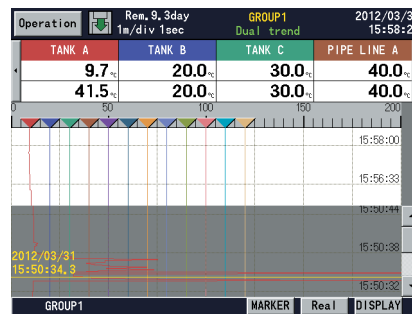

Historical trend screen

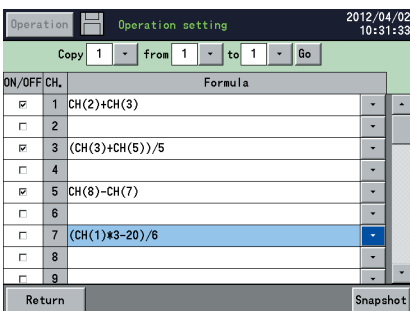
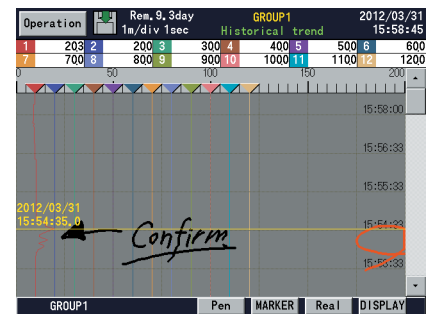

Math functions

Easy to set and manage the formula.

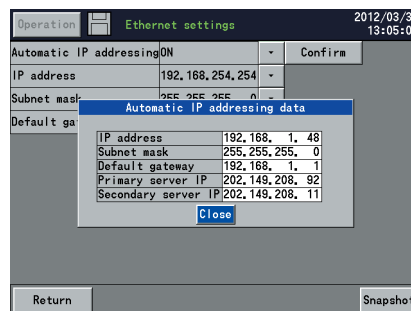

Various communication function

Enable to use E-mail, FTP, HTTP, SNTp, and DHCP. (Automatic acquisition IP address)

*Graphic screen feature is provided optionally. BMP image has to be prepared by customer.

INPUT SPECIFICATIONS

Measuring points: 6 points, 12 points
 Input types: Universal
 DC voltage --- $\pm 13.8\text{mV}$, $\pm 27.6\text{mV}$, $\pm 69.0\text{mV}$
 $\pm 200\text{mV}$, $\pm 500\text{mV}$, $\pm 2\text{V}$
 $\pm 5\text{V}^*$, $\pm 10\text{V}^*$, $\pm 20\text{V}^*$, $\pm 50\text{V}^*$
 (*with built-in voltage divider)
 DC current --- With external shunt resistor (sold separately)
 Thermocouple --- B, R, S, K, E, J, T, N, PtRh40-PtRh20,
 W-WRe26, WRe5-WRe26, PlatinellII, NiMo-
 Ni, CR-AuFe, U, L
 Resistance thermometer --- Pt100, JPt100, Pt-Co, Pt50
 *Contact CHINO for Nickel-100, Pt130, Pt25, Pt46, Cu10, Cu25,
 Cu53
 Accuracy ratings: Refer to the table of measuring range and accuracy
 ratings
 Reference junction compensation accuracy:
 K, E, J, T, N, PlatinellIII --- $\pm 0.5^\circ\text{C}$ or less
 R, S, W-WRe26, WRe5-WRe26, NiMo-Ni,
 CR-AuFe, U, L --- $\pm 1.0^\circ\text{C}$ or less
 Sampling rate: Approximately 1second/12 points, 0.1 second/4 points
 Burnout: Disconnection of input signal is detected on
 thermocouple and resistance thermometer input.
 UP/DOWN/DISABLE is selectable.
 Scaling: Range/scale is selectable.
 Digital filter: Programming FIR filter for each point (common to
 all points)
 Allowable signal source resistance:
 Thermocouple input (burnout disable/
 DC voltage input ($\pm 2\text{V}$ or less) --- $1\text{k}\Omega$ or less
 DC voltage input ($\pm 5\text{V}$ or more) --- 100Ω or less
 Resistance thermometer --- Per wire 10Ω or less
 (same resistance for 3 wires)
 Input resistance: Thermocouple --- Approx. $1\text{M}\Omega$
 DC voltage input --- $\pm 2\text{V}$ or less : Approx. $1\text{M}\Omega$
 $\pm 5\text{V}$ to $\pm 50\text{V}$: Approx. $1\text{M}\Omega$
 Maximum input voltage:
 DC voltage input ($\pm 2\text{V}$ or less/
 Thermocouple input (burnout enable) --- 10VDC
 Resistance thermometer input --- 6VDC
 DC voltage input ($\pm 5\text{V}$ to $\pm 50\text{V}$) --- 60VDC
 Dielectric strength between channels:
 1000V AC or more between each channel
 (High strength semiconductor relay used)
 (B terminal of resistance thermometer is shorted inside between
 channels)
 Common mode rejection ratio:
 120dB or more (50 or 60Hz)
 Series mode rejection ratio:
 50dB or more (50 or 60Hz)

RECORDING SPECIFICATIONS

Internal memory: 8MB
 Additional memory: CF card (Up to 8GB)
 256MB standard attached, Apacer Technology made
 recommended
 USB memory stick (Up to 8GB)
 Not all USB memory stick allowable
 Recording cycle: 100, 200, 500ms
 1, 2, 3, 5, 10, 15, 20, 30s
 1, 2, 3, 5, 10, 15, 20, 30, 60min
 Logging data: Measured data --- File name (group name), time of day,
 month and year of recording start, maker text, measured data,
 alarm status/types
 Setting parameter
 Operation result data
 Storing types: Binary/CSV
 Storing methods: Manual start/stop (dedicated touch key operation)
 Schedule (designation for time of day and date)
 Trigger signal (alarm event, digital input)
 *Pre-trigger is selectable
 Measuring numbers of pre-trigger --- Maximum 950 data
 Recording group: Recording cycle 1s or slower --- up to 5 groups of 44
 points/group can be programmed
 (Up to total of 100 points)

Recording cycle	256MB	512MB	1GB	2GB	8GB
1sec	126 days	253 days	1.4 yrs	2.8 yrs	11.2 yrs

When 12 channels recorded in sampling mode (real data).

Recording cycle	256MB	512MB	1GB	2GB	8GB
1sec	63.2 days	126 days	253 days	1.4 yrs	5.6 yrs

COMPUTATION SPECIFICATIONS

Computation points: Maximum 44 points
 Computation types: Arithmetic operations --- Addition, subtraction,
 multiplication,
 division, remainder, exponential
 Equality, inequality, great, less,
 equality /great, equality / less
 Logical operations --- AND, OR, XOR, NOT
 General functions --- Round-up, round-down, absolute
 value, square root, exponent of e,
 natural logarithm, common logarithm
 Integration operations --- Analog integration, digital
 integration
 Channel data operations --- Measured data computation,
 calculated data computation
 Others --- Dew point, relative humidity, F-value
 Remaining amount of CF card

ALARM SPECIFICATIONS

Setups: Up to 4 alarms can be programmed per channel
 Alarm types: Upper limit, lower limit, differential upper limit, differential lower
 limit (deadband is selectable), abnormal data
 Delay function: Setup range of alarm delay --- 1 to 3600 seconds
 Alarm settings: AND/OR selectable
 Alarm outputs: Refer to option specification

DISPLAY SPECIFICATIONS

Display: 5.7"VGA TFT color LCD VGA (640x480 dots)
 Display types: Measured data display (Trend screen, Data screen, Bar-graph
 screen)
 Historical trend display (simultaneous display with Real-time
 trend is available)
 Information display (alarm display, marker list, file list)
 Setting screen (alarm, computation, memory, system,
 maintenance, communication, etc.)
 Trend screen: 12 colors selectable
 Display screen --- 5 screens (5 groups)
 Display points --- Maximum 44 points/screen
 Time axis direction --- Vertical or horizontal
 Line width --- 5 step selection
 Scale display --- 4 scales
 Tag/data display --- Show/hidden selectable
 Marker display
 Circular trend
 Data screen: Display screen --- 5 screens (5 groups)
 Display points --- Maximum 44 points/screen
 Display contents --- Measured value, channel/tag, unit, alarm
 status
 Bargraph screen: 12 colors selectable
 Display screen --- 5 screens (5 groups)
 Display points --- Maximum 44 points/screen
 Display direction --- Vertical or horizontal
 Scale display --- 1 scale
 Information display: Alarm display (alarm activation/released history display)
 Marker list
 File list (group data file list display)
 LCD back light: Auto/manual OFF function
 Unit information (Model, serial no., option, etc.)
 Brightness --- 4 levels adjustment

*The LCD display may contain some pixels that always or never illuminate, and the brightness of some areas of the display may appear uneven. There are typical LCD performance characteristics and do not constitute malfunctions.

COMMUNICATION FUNCTIONS

Network

Communication type: Ethernet (10BASE-T/100BASE-TX)
 FTP server: Data file can be read from the network computer
 Transfer a data file to a network server
 FTP client: The time can be synchronized to the time of SNTP server
 SNTP client: Conformed to HTTP1.0 --- Displays the alarm, information of
 maintenance by browser software (Internet Explorer5.0 or later,
 Netscape6.0 or later, Opera7 or later)
 Web server: *User's ID and password registration available
 E-Mail: E-Mail notification at specified time for alarm activation
 Report data at specified time is selectable from all registered
 data
 Notification address --- Maximum 8 contacts
 Automatic IP address acquisition
 DHCP client: Automatic IP address acquisition

USB Communications

USB: Communication type --- USB1.1
 Transfer systems --- Bulk transfer, control transfer
 File transfer by connecting as removable disk drive



CONNECTIVITY

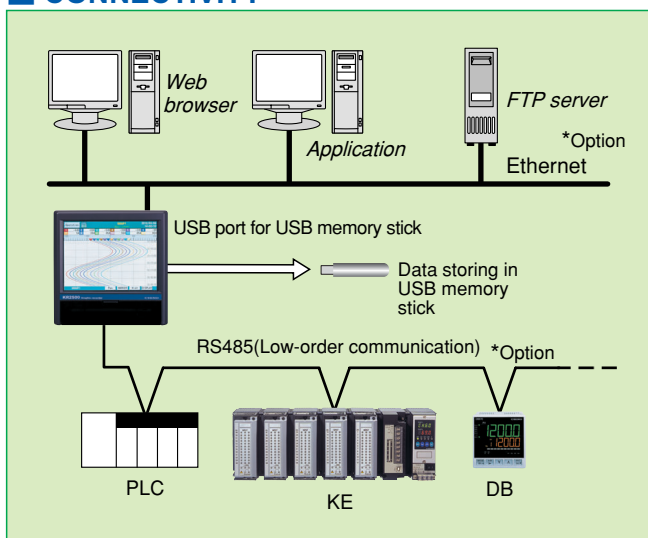

KR2S SERIES

PROGRAMMING/OPERATION SPECIFICATIONS

HOME settings: Simple recording settings --- Common setting to all channels
Parameter programming for all channels together, recording cycle, selection settings

MENU settings: Input/computation programming --- Input parameter, computation parameter
DISP settings --- Data channel parameter, group parameter, common parameter (combination display, trend vertical/horizontal)
Alarm settings
File settings (5 individual files) --- Storing method settings
Marker text settings
System settings --- Communication, clock, maintenance, key lock, password, screen, etc.
Operating screen selection --- Trend, data, bar-graph, historical trend, alarm display, maker list
Display selection on each screen --- Group 1 to 5 selectable

GENERAL SPECIFICATIONS

Rated power voltage: 100 to 240V AC (universal power supply) 50/60Hz
Maximum power consumption:
35VA
Reference operating condition:
Ambient temperature --- 21 to 25°C,
Ambient humidity --- 45 to 65%RH
Power voltage --- 100V AC±1.0%
Power frequency --- 50/60Hz±0.5%
Attitude --- Left/right 0°, forward/backward 0°
Warm-up time --- Longer than 30 minutes

Normal operating condition:
Ambient temperature --- 0 to 50°C
Ambient humidity --- 20 to 80%RH
Power voltage --- 90 to 264V AC
Power frequency --- 50/60Hz±2%
Attitude --- left/right 0°, forward tilting 0°, Backward tilting 0° to 20°

Transport condition (at the packed condition on shipment from our factory):
Ambient temperature --- -20 to 60°C
Ambient humidity --- 5 to 90%RH (No dew condensation)
Vibration --- 10 to 60Hz 0.5G (4.9m/S²) or less
Impact --- 40G (392m/S²) or less

Storage condition:
Ambient temperature --- -20 to 60°C
Ambient humidity --- 5 to 90%RH (No dew condensation)

Power failure protection:
Flash memory and SDRAM stores the setting.
Flash memory stores the data.
Lithium battery back up the clock and parameter RAM for more than 5 years (provided that the daily operating hours is longer than 8hours).

Insulation resistance: Secondary terminals and protective conductor terminals --- 20MΩ or more at 500V DC
Primary terminals and protective conductor terminals --- 20MΩ or more at 500V DC
Primary and secondary terminals --- 20MΩ or more at 500V DC
Primary terminals: power terminals (L,N), alarm output terminals
Secondary terminals: measuring input terminals, digital input terminals, communications terminals

Dielectric strength: Secondary terminals and protective conductor terminals --- 1 minute at 500V AC
Primary terminals and protective conductor terminals --- 1 minute at 1500V AC
Primary and secondary terminals --- 1 minute at 2300V AC
Primary terminals: power terminals (L,N), alarm output terminals
Secondary terminals: measuring input terminals, digital input terminals, communications terminals

Case assembly material:
Front bezel --- ABS resin
Case --- Steel

Color:
Front bezel --- Black (equivalent to Munsell N3.0)
Case --- Painting color, gray (equivalent to Munsell N7.0)

Weight:
Mounting:
Terminal screws:
2.1kg (12 points input with full options)
Panel mounting
Power terminals/protective conductor terminals/communications terminals --- M4.0
Measuring input terminals/alarm output terminals/digital input terminals --- M3.5
Communications terminals --- M3.0

STANDARDS

CE : EMC directive --- EN61326-1
Class A
Low voltage directive --- EN61010-1, EN61010-2-030
Protection: Conformed to IEC60529 IP54 (recorder front bezel)

OPTION SPECIFICATIONS

Options	Specifications
Alarm output	Mechanical relay (c contact) output for alarm activation and input error. Output point: 4 or 2 points Contact capacity: resistive load 3A, inductive load 1.5A
Digital input (Non-voltage contact input/ 4 or 2 points)	ON/OFF signal ON/OFF input recording
	Pulse input Maximum 10Hz pulse input Used for flow rate, operation time and frequency
Communications interface	External drive The following operations are available (selectable by parameter) · Data memory triggering · Marker display · Integrated calculation reset
	High and low-order communication Communications interface for high and low-order unit RS485 (MODBUS) Choose one function from the following 3 functions. · Communication interface for high-order unit · Recording input data of CHINO products connected to a low-order unit and data in PLC register. Display and record parameter setting, measured value, setting value, etc. of up to 16 CHINO controllers. Recording points: 6-channel specification - 34 points 12-channel specification - 28 points Connectable models: KE, KR2S, KR3S, KR2000, KR3000, LE5000, AL3000, AL4000, AH3000, AH4000, DB1000, 2000, LT230, 830, 350, 370, 450, 470, KP1000, KP2000, DP-G (data collection only) JU, JW, SE3000 · Transfer input data of KR2S to PLC. The input data can be written on PLC only. Data writing points: 44 points Connectable PLC: Mitsubishi Electric Corporation MELSEC AnA, QnA, QnAS, FX series OMRON Corporation SYMAC series (Note) Separate purchase of protocol converter SC8-10 (optional) is required for connection to OMRON PLC.
Custom Graphic Screen	By KR Screen Designer (optional), create graphic screen by PC and display to KR screen via CF card. KR measuring value can be located to the screen.
Others	Handle and rubber feet

ACCESSORIES (SOLD SEPARATELY)

Name	Description
Resistor for DC current input 100Ω	For 50mA
Resistor for DC current input 250Ω	For 20mA
CF card	128MB, 256MB, 512MB, 1GB, 2GB, 4GB, 8GB
Card adapter	For PC card

KR SCREEN DESIGNER (sold separately) (NEW)

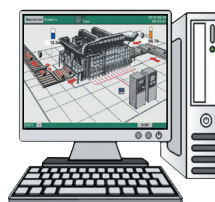

Model: KS3200-000
OS: Windows Vista/7/8
Others: Your OS recommended requirements or better

MEASURING RANGES

Input type	Measuring range	Accuracy ratings
DC voltage	-13.80 to 13.80mV -27.60 to 27.60mV -69.00 to 69.00mV -200.0 to 200.0mV -500.0 to 500.0mV -2.000 to 2.000V	±0.1%±1digit
	(with built-in voltage divider) -5.000 to 5.000V -10.00 to 10.00V -20.00 to 20.00V -50.00 to 50.00V	
T/C	K -200.0 to 300.0°C -200.0 to 600.0°C -200 to 1370°C	±0.1%±1digit * -200 to 0°C: ±0.2%±1digit
	E -200.0 to 200.0°C -200.0 to 350.0°C -200 to 900°C	
	J -200.0 to 250.0°C -200.0 to 500.0°C -200 to 1200°C	
	T -200.0 to 250.0°C -200.0 to 400.0°C	
	R 0 to 1200°C 0 to 1760°C	±0.1%±1digit * 0 to 400°C: ±0.2%±1digit
	S 0 to 1300°C 0 to 1760°C	
	B 0 to 1820°C	±0.1%±1digit * 0 to 400°C: Out of accuracy ratings * 400 to 800°C: 0.15%±1digit
	N -200.0 to 400.0°C -200.0 to 750.0°C -200 to 1300°C	±0.15%±1digit * -200 to 0°C: ±0.3%±1digit
	W-WRe26 0 to 2315°C	±0.15%±1digit * 0 to 100°C: ±4%±1digit * 100 to 400°C: ±0.5%±1digit
	WRe5-WRe26 0 to 2315°C	±0.2%±1digit
	PtRh40-PtRh20 0 to 1888°C	±0.2%±1digit * 0 to 300°C: ±1.5%±1digit * 300 to 800°C: ±0.8%±1digit
	NiMo-Ni -50.0 to 290.0°C -50.0 to 600.0°C -50 to 1310°C	±0.2%±1digit
	CR-AuFe 0.0 to 280.0K	±0.2%±1digit * 0 to 20K: ±0.5%±1digit * 20 to 50K: ±0.3%±1digit
	PlatineII 0.0 to 350.0°C 0.0 to 650.0°C 0 to 1395°C	±0.15%±1digit
U -200.0 to 250.0°C -200.0 to 500.0°C -200.0 to 600.0°C	±0.15%±1digit * -200 to 0°C: ±0.3%±1digit	
L -200.0 to 250.0°C -200.0 to 500.0°C -200 to 900°C	±0.1%±1digit * -200 to 0°C: ±0.2%±1digit	
RTD	Pt100 -140.0 to 150.0°C -200.0 to 300.0°C -200.0 to 850.0°C	±0.1%±1digit * -140.0 to 150.0°C 700 to 850°C: ±0.15%±1digit
	JPt100 -140.0 to 150.0°C -200.0 to 300.0°C -200.0 to 649.0°C	±0.1%±1digit * -140.0 to 150.0°C: ±0.15%±1digit
	Pt50 -200.0 to 649.0°C	±0.1%±1digit
	Pt-Co 4.0 to 374.0K	±0.15%±1digit * 4 to 50K: ±0.3%±1digit

Note: The accuracy ratings are converted into the measuring range under reference operating condition. Thermocouple input does not contain reference junction compensation accuracy.
 K,E,J,T,R,S,B,N:IEC584,JIS C1602-1995
 W-WRe26,WRe5-WRe26,PtRh40-PtRh20,PlatineII,NiMo-Ni,
 Cr-AuFe:ASTM Vol14.03
 U(Cu-CuNi),L(Fe-CuNi):DIN43710
 Pt100:IEC751(1995),JIS C1604-1997
 JPt100:JIS C1606-1989

APPLICATION SOFTWARE ZAILA (sold separately)

The software is applied for replay display/wave editing operation of recorded data in KR2S series. It has replay display of vertical/horizontal trend and circular trend function, and also analyzing function such as magnify/reduce/partially magnify of graphs and message insert.

Display examples

Trend display window (vertical flow)

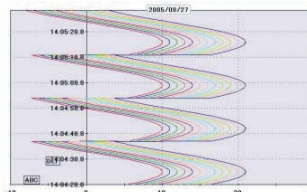

Trend display window (horizontal flow)

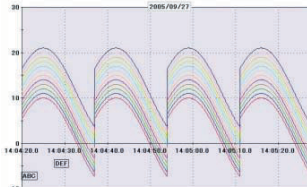

Trend display window (circular trend)

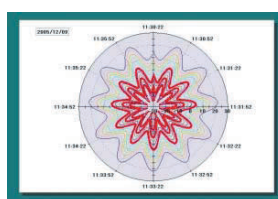

Bar-graph

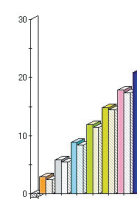

Main functions

Trend display

Selectable from trend display window (vertical flow, horizontal flow) and circular trend display window.

Continuous replay display window

Trend is scrolled continuously (automatically).
 Scroll changes by speed and renewal data no.

Data list display window

Displays registered data as list display.

Bar-graph

Displays by bar. Message can be inserted into bar-graph.

Data between markers

Displays date/time, time difference between 2 data, data difference, maximum, minimum, average, standard deviation and median among all data.

Alarm display

Points for alarm activation at each level are displayed on a trend graph.

Settings

Cursor, trend line, scale axis, time axis, title input on the graph, graph assistant and magnify/reduce/rotation of graphs

Data conversion

Exporting to Excel, and converting to CSV file or TEXT file are available.

ENVIRONMENT

CPU	Your OS recommended CPU and/or upper grade
OS	Windows XP Home / XP Pro / VISTA / 7 *Internet Explorer 4.0 or later
Memory	Your OS recommended memory or larger
Disk drive	CD-ROM drive: 1 drive or more Hard disk drive: Disk space of 1 drive or more for 100MB or more
Language	Japanese, English, Chinese (simplified and traditional characters), Korean

■ TERMINAL ARRANGEMENT

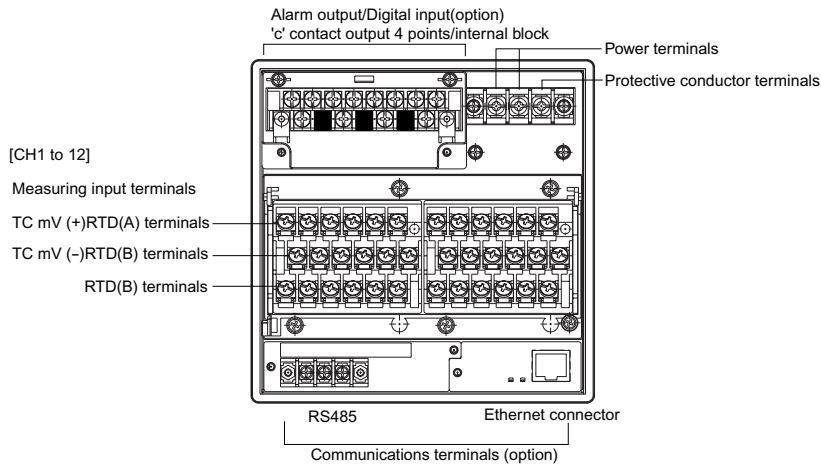

● Alarm relay output (4 points 'c' contact)

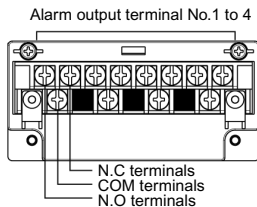

● Digital input (No voltage contact input 4 points)

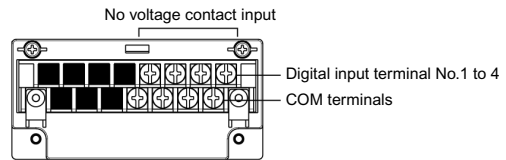

● Alarm relay output (2 points 'c' contact) + Digital input (No voltage contact input 2 points)

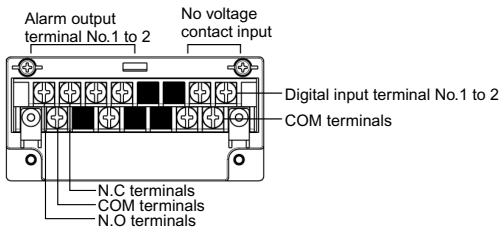

● Communication terminal

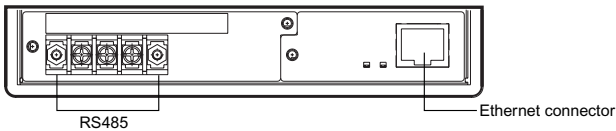

■ DIMENSIONS

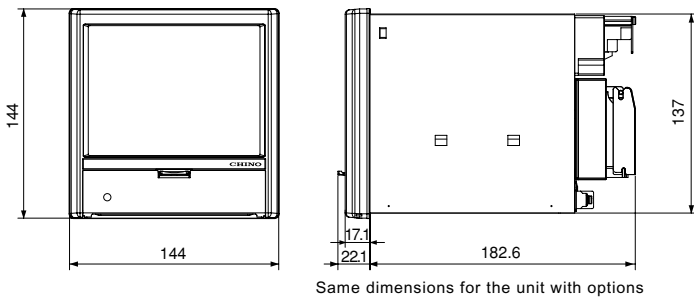

● PANEL CUTOUT

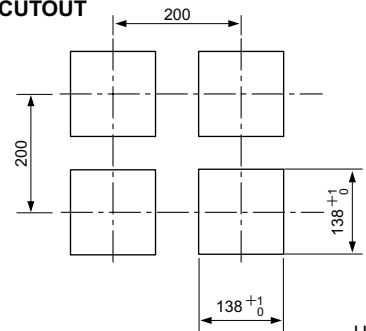

Unit: mm

Specifications subject to change without notice. Printed in Japan (I) 2016. 4

CHINO CORPORATION

32-8 KUMANO-CHO, ITABASHI-KU, TOKYO 173-8632
 Telephone : +81-3-3956-2171
 Facsimile : +81-3-3956-0915
 E-mail : inter@chino.co.jp
 Website : www.chino.co.jp/