



Mini8™

Engineering Handbook

Mini8 Multi-loop process controller
Version 2.50.

HA028581/12
March 2013

© 2013 Eurotherm Limited

All rights are strictly reserved. No part of this document may be reproduced, modified, or transmitted in any form by any means, nor may it be stored in a retrieval system other than for the purpose to act as an aid in operating the equipment to which the document relates, without the prior, written permission of Eurotherm Limited.



Eurotherm Limited pursues a policy of continuous development and product improvement. The specification in this document may therefore be changed without notice. The information in this document is given in good faith, but is intended for guidance only. Eurotherm Limited will accept no responsibility for any losses arising from errors in this document.

Mini8 controller - Multi-Loop Process Controller

Warning Back up Battery.....	8
1. CHAPTER 1 INSTALLATION AND OPERATION	9
1.1 What Instrument Do I Have?.....	9
1.2 Mini8 Controller Ordering Code.....	10
1.3 How to Install the Controller.....	11
1.3.1 Dimensions.....	11
1.3.2 To Install the Controller.....	11
1.3.3 Environmental Requirements.....	11
1.4 Electrical Connections	12
1.4.1 Power Supply.....	12
1.4.2 Fixed IO Connections.....	13
1.4.3 Digital Communications Connections	13
1.4.4 Configuration Port (CC).....	13
1.4.5 Screened Communications Cables	13
1.4.6 Modbus.....	14
1.4.7 DeviceNet / CANopen.....	16
1.4.8 Enhanced DeviceNet Interface	18
1.4.9 Profibus DP	19
1.4.10 EtherNet (Modbus TCP).....	20
1.4.11 EtherNet/IP.....	21
1.4.12 Thermocouple Input TC4 and TC8	22
1.4.13 RTD / PT100 Input RT4.....	22
1.4.14 Logic Input DI8	23
1.4.15 Logic Output DO8.....	23
1.4.16 Relay Output RL8.....	24
1.4.17 Analogue Output AO4 and AO8	24
1.4.18 Current Transformer Input Module CT3.....	25
1.5 Adding or Replacing an IO Module.....	26
1.6 Mini8 Controller LED Indicators.....	27
1.6.1 Status Indication for Enhanced DeviceNet.....	28
1.6.2 Status Indication for EtherNet/IP	29
2. CHAPTER 2 USING THE MINI8 CONTROLLER.....	30
2.1 iTools	30
2.1.1 iTools OPC Open server.....	30
2.2 Modbus, single register, SCADA addressing	30
2.3 Modbus (Floating Point)	31
2.4 Fieldbus.....	31
2.5 EtherNet (Modbus TCP)	31
2.6 Mini8 Controller Execution.....	31
2.7 The iTools Operator Interface	32
2.7.1 Scanning	32
2.7.2 Browsing and Changing Parameter Values.....	32
2.8 Recipe Editor	34
2.8.1 Recipe Menu Commands.....	34
2.9 OPCScope.....	35
2.9.1 OPC Scope List Window Context Menu	36
2.9.2 OPC Scope Chart Window.....	36
2.9.3 OPC Server	38
3. CHAPTER 3 CONFIGURATION USING ITOOLS	39
3.1 Configuration.....	39
3.1.1 On-Line/Off-line Configuration.....	39
3.2 Connecting a PC to the Mini8 Controller.....	39
3.2.1 Configuration Cable and Clip.....	39
3.2.2 Scanning	39
3.3 Cloning	40
3.4 Configuring the Mini8 Controller.....	41
3.4.1 Function Blocks	41
3.4.2 Soft Wiring.....	42
3.5 Simple Worked Example	43

3.5.1	The I/O	43
3.5.2	Wiring.....	46
3.6	Graphical Wiring Editor.....	49
3.6.1	Graphical Wiring Toolbar.....	50
3.6.2	Function Block.....	50
3.6.3	Wire	50
3.6.4	Block Execution Order.....	50
3.6.5	Using Function Blocks	50
3.6.6	Tooltips	51
3.6.7	Function Block State	52
3.6.8	Using Wires.....	53
3.6.9	Using Comments.....	54
3.6.10	Using Monitors.....	55
3.6.11	Downloading	55
3.6.12	Selections	55
3.6.13	Colours	56
3.6.14	Diagram Context Menu.....	56
3.6.15	Wiring Floats with Status Information	57
3.6.16	Edge Wires.....	58
4.	CHAPTER 4 MINI8 CONTROLLER OVERVIEW	59
4.1	Complete list of Function Blocks.....	60
5.	CHAPTER 5 ACCESS FOLDER	61
6.	CHAPTER 6 INSTRUMENT FOLDER.....	62
6.1	Instrument / Enables.....	62
6.2	Instrument Options	63
6.3	Instrument / InstInfo.....	63
6.4	Instrument / Diagnostics	64
7.	CHAPTER 7 I/O FOLDER	66
7.1	Module ID	66
7.1.1	Modules.....	66
7.2	Logic Input	67
7.2.1	Logic Input Parameters.....	67
7.3	Logic Output.....	68
7.3.1	Logic Out Parameters.....	68
7.3.2	Logic Output Scaling	69
7.3.3	Example: To Scale a Proportioning Logic Output.....	69
7.4	Relay Output.....	70
7.4.1	Relay Parameters.....	70
7.5	Thermocouple Input	71
7.5.1	Thermocouple Input Parameters.....	71
7.5.2	Linearisation Types and Ranges	73
7.5.3	CJC Type	73
7.5.4	Sensor Break Value	74
7.5.5	Fallback.....	74
7.5.6	User Calibration (Two Point)	75
7.5.7	PV Offset (Single Point).....	75
7.5.8	Using TC4 or TC8 channel as a mV input	76
7.6	Resistance Thermometer Input	77
7.6.1	RT Input Parameters.....	77
7.6.2	Linearisation Types and Ranges	78
7.6.3	Using RT4 as mA input.....	78
7.7	Analogue Output	79
7.7.1	Example - 4 to 20mA Analogue Output.....	79
7.8	Fixed IO.....	80
7.9	Current Monitor.....	81
7.9.2	Single Phase Configurations.....	82
7.9.3	Three Phase Configuration	84
7.9.4	Parameter Configuration.....	85
7.9.5	Commissioning	86
7.9.6	Calibration	88

8. CHAPTER 8 ALARMS.....	89
8.1 Further Alarm Definitions.....	89
8.2 Analogue Alarms.....	90
8.2.1 Analogue Alarm Types.....	90
8.3 Digital Alarms	91
8.3.1 Digital Alarm Types.....	91
8.4 Alarm Outputs	91
8.4.1 How Alarms are Indicated	91
8.4.2 To Acknowledge an Alarm.....	91
8.5 Alarm Parameters.....	92
8.5.1 Example: To Configure Alarm 1	93
8.6 Digital Alarm Parameters.....	94
8.6.1 Example: To Configure DigAlarm 1	94
8.7 Alarm Summary.....	95
8.8 Alarm Log.....	97
9. CHAPTER 9 BCD INPUT.....	98
9.1 BCD Parameters	98
9.1.1 Example: To wire a BCD Input.....	99
10. CHAPTER 10 DIGITAL COMMUNICATIONS	100
10.1 Configuration Port (CC).....	100
10.1.1 Configuration Communications Parameters.....	100
10.2 Field Communications Port (FC)	100
10.2.1 Communications Identity.....	100
10.3 Modbus	101
10.3.1 Modbus Connections.....	101
10.3.2 Modbus Address Switch	101
10.3.3 Baud Rate	101
10.3.4 Parity.....	101
10.3.5 RX/TX Delay Time.....	101
10.4 Modbus Broadcast Master Communications	102
10.4.1 Mini8 Controller Broadcast Master	102
10.4.2 Modbus Parameters.....	103
10.5 DeviceNet	104
10.6 Enhanced DeviceNet Interface.....	104
10.6.1 Address Switch	104
10.6.2 Baud Switch.....	104
10.7 Switch Position in iTools.....	104
10.7.1 DeviceNet Parameters	105
10.8 CANopen.....	106
10.8.1 Instrument setup.....	106
10.8.2 Mini8 Controller CANopen Features.....	106
10.8.3 Communication Interface	107
10.8.4 Network Management (NMT).....	108
10.8.5 Device Profile DS-404	109
10.8.6 Default PDOs	109
10.8.7 Enabling and Disabling PDO Communications	112
10.8.8 Changing PDO Mapping.....	112
10.8.9 Remapping over the network.....	115
10.8.10 Enabling & Disabling PDO Change of State transmission.....	117
10.8.11 General Communication Objects	117
10.9 Profibus	122
10.9.1 Profibus Parameters.....	122
10.10 EtherNet (Modbus TCP)	123
10.10.1 Instrument setup.....	123
10.10.2 Unit Identity.....	123
10.10.3 Dynamic Host Configuration Protocol (DHCP) Settings	123
10.10.4 iTools Setup	124
10.10.5 EtherNet Parameters.....	125
10.11 EtherNet/IP	126
10.11.1 Feature Switch	126
10.11.2 Configuration using iTools	126

10.11.3	EtherNet/IP Parameters	127
10.11.4	Input Definition Table	128
10.11.5	Output Definition Table	129
10.11.6	Requested Packet Interval	129
10.12	Example - Connect mini8 Controller to Allen-Bradley PLC via EtherNet/IP	130
10.12.1	Installation	130
10.12.2	Setting Up The Link Between Windows And The Plc Network	130
10.12.3	Updating Firmware	132
10.12.4	Completing the Link.....	132
10.12.5	Creating a Network Scanner	134
10.12.6	Create or Load a Mini8 Controller Configuration	137
10.12.7	Run Mode.....	138
10.12.8	Monitor Parameters.....	139
10.12.9	Status Indicators	139
10.12.10	Mini8 Controller on an Ethernet/Ip Network.....	140
10.12.11	TROUBLESHOOTING	141
11.	CHAPTER 11 COUNTERS, TIMERS, TOTALISERS, RT CLOCK.....	142
11.1	Counters	142
11.1.1	Counter Parameters	143
11.2	Timers	144
11.2.1	Timer Types.....	144
11.2.2	On Pulse Timer Mode	144
11.2.3	On Delay Timer Mode.....	145
11.2.4	One Shot Timer Mode	146
11.2.5	Minimum On Timer or Compressor Mode	147
11.2.6	Timer Parameters	148
11.3	Totalisers	149
11.3.1	Totaliser Parameters.....	150
11.4	Real Time Clock.....	151
11.4.1	Real Time Clock Parameters.....	151
12.	CHAPTER 12 APPLICATIONS	152
12.1	Humidity.....	152
12.1.1	Overview	152
12.1.2	Temperature Control of an Environmental Chamber	152
12.1.3	Humidity Control of an Environmental Chamber.....	152
12.1.4	Humidity Parameters.....	153
12.2	Zirconia (Carbon Potential) Control.....	154
12.2.1	Temperature Control	154
12.2.2	Carbon Potential Control.....	154
12.2.3	Sooting Alarm.....	154
12.2.4	Automatic Probe Cleaning	154
12.2.5	Endothermic Gas Correction.....	154
12.2.6	Clean Probe	154
12.2.7	Probe Status.....	154
12.2.8	Zirconia Parameters.....	155
13.	CHAPTER 13 INPUT MONITOR	157
13.1	Description.....	157
13.1.1	Maximum Detect	157
13.1.2	Minimum Detect	157
13.1.3	Time Above Threshold.....	157
13.2	Input Monitor Parameters.....	158
14.	CHAPTER 14 LOGIC AND MATHS OPERATORS.....	159
14.1	Logic Operators.....	159
14.1.1	Logic 8	159
14.1.2	2 input Logic Operations.....	160
14.1.3	Logic Operator Parameters	161
14.2	Eight Input Logic Operators	162
14.3	Maths Operators	163
14.3.1	Math Operations.....	164
14.3.2	Math Operator Parameters.....	165
14.3.3	Sample and Hold Operation	166
14.4	Multiple Input Operator Block	167
14.4.1	Cascaded operation.....	168

14.4.2	Fallback Strategy	168
14.4.3	Multiple Input Operator Block Parameters	169
14.5	Eight Input Analog Multiplexers	170
14.5.1	Multiple Input Operator Parameters.....	170
14.5.2	Fallback	170
15	CHAPTER 15 INPUT CHARACTERISATION.....	171
15.1	Input Linearisation	171
15.1.1	Compensation for Sensor Non-Linearities	172
15.1.2	Input Linearisation Parameters.....	173
15.2	Polynomial	174
16	CHAPTER 16 LOAD.....	176
16.1	Load Parameters	176
17	CHAPTER 17 CONTROL LOOP SET UP	177
17.1	What is a Control Loop?.....	177
17.2	Loop Parameters - Main	178
17.3	Loop Set up.....	179
17.3.1	Types of Control Loop	179
17.4	PID Control.....	180
17.4.1	Proportional Band	181
17.4.2	Integral Term	181
17.4.3	Derivative Term	182
17.4.4	High and Low Cutback.....	183
17.4.5	Integral action and manual reset	183
17.4.6	Relative Cool Gain.....	183
17.4.7	Loop Break.....	184
17.4.8	Cooling Algorithm.....	184
17.4.9	Gain Scheduling	185
17.4.10	PID Parameters	186
17.5.1	Loop Response.....	187
17.5.2	Initial Settings.....	187
17.5.3	Multi-zone applications.....	188
17.5.4	Automatic Tuning	189
17.5.5	Tune Parameters.....	190
17.5.6	To Auto Tune a Loop - Initial Settings.....	190
17.5.7	To Start Autotune	191
17.5.8	Autotune and Sensor Break.....	191
17.5.9	Autotune and Inhibit	191
17.5.10	Autotune and Gain Scheduling.....	191
17.5.11	Autotune from Below SP - Heat/Cool.....	192
17.5.12	Autotune From Below SP - Heat Only	193
17.5.13	Autotune at Setpoint - Heat/Cool.....	194
17.5.14	Failure Modes.....	195
17.5.15	Manual Tuning.....	196
17.5.16	Manually Setting Relative Cool Gain.....	196
17.5.17	Manually Setting the Cutback Values	197
17.6	Setpoint Function Block	198
17.6.1	Setpoint Function Block.....	198
17.6.2	SP Tracking.....	199
17.6.3	Manual Tracking	199
17.6.4	Rate Limit.....	199
17.6.5	Setpoint Parameters.....	199
17.6.6	Setpoint Limits	201
17.6.7	Setpoint Rate Limit	201
17.6.8	Setpoint Tracking	202
17.6.9	Manual Tracking	202
17.7	Output Function Block.....	203
17.7.1	Output Limits	206
17.7.2	Output Rate Limit	207
17.7.3	Sensor Break Mode	207
17.7.4	Forced Output.....	207
17.7.5	Feedforward	208
17.7.6	Effect of Control Action, Hysteresis and Deadband.....	209

18. CHAPTER 18 SETPOINT PROGRAMMER	210
18.1 INTRODUCTION	210
18.1.1 Time to Target Programmer.....	210
18.1.2 Ramp Rate Programmer.....	211
18.2 Mini8 Controller Programmer Block(s)	211
18.3 Segment Types	212
18.3.1 Rate.....	212
18.3.2 Dwell.....	212
18.3.3 Step.....	212
18.3.4 Time.....	212
18.3.5 GoBack.....	212
18.3.6 Wait.....	213
18.3.7 End.....	213
18.4 Output Events	214
18.4.1 Digital Events.....	214
18.4.2 PV Event & User Value.....	215
18.4.3 Time Event.....	216
18.5 Holdback	218
18.5.1 Guaranteed Soak.....	218
18.6 PID Select	219
18.7 Program Cycles	219
18.7.1 Servo.....	219
18.8 Power Fail Recovery	220
18.8.1 Ramp (Power fail during Dwell segments.).....	220
18.8.2 Ramp (power fail during Ramp segments).....	220
18.8.3 Ramp (power fail during Time-to-target segments).....	220
18.9 To Run, Hold or Reset a Program	221
18.9.1 Run.....	221
18.9.2 Reset.....	221
18.9.3 Hold.....	221
18.9.4 Skip segment.....	221
18.9.5 Advance segment.....	222
18.9.6 Fast.....	222
18.10 PV Start	222
18.11 Configuring the Programmer	223
18.12 Programmer Run Status	226
18.13 Creating a Program	227
18.14 Program Editor	227
18.14.1 Analog View.....	228
18.14.2 Digital View.....	230
18.14.3 Saving & Loading Programs.....	230
18.14.4 Printing a Program.....	231
18.15 Wiring the Programmer Function Block.	232
19. CHAPTER 19 SWITCH OVER	234
19.1 Switch Over Parameters	235
20. CHAPTER 20 TRANSDUCER SCALING	236
20.1 Auto-Tare Calibration	236
20.2 Load Cell	237
20.3 Comparison Calibration	237
20.4 Transducer Scaling Parameters	237
20.4.1 Parameter Notes.....	239
20.4.2 Tare Calibration.....	239
20.4.3 Load Cell.....	240
20.4.4 Comparison Calibration.....	240
21. CHAPTER 21 USER VALUES	241
21.1 User Value Parameters	241
22. CHAPTER 22 CALIBRATION	242
22.1 TC4 / TC8 User calibration	242
22.1.1 Set Up.....	242
22.1.2 Zero Calibration.....	242

22.1.3	Voltage Calibration	242
22.1.4	CJC Calibration	242
22.1.5	Sensor-Break Limit Check.....	242
22.2	To Return to TC4/TC8 Factory Calibration	243
22.3	RT4 User calibration.....	243
22.3.1	Set Up.....	243
22.3.2	Calibration.....	243
22.4	To Return to RT4 Factory Calibration	243
22.5	Calibration Parameters.....	244
23.	CHAPTER 23 OEM SECURITY.....	245
23.1	Introduction	245
23.2	Using OEM Security.....	245
23.3	Step 1 - View iTools OPC Server.....	246
23.4	Step 2 - Create Custom Tags.....	247
23.5	Step 3 - Activate OEM Security.....	249
23.6	Step 4 - Deactivate OEM Security	250
23.7	Erasing Memory	250
24.	APPENDIX A MODBUS SCADA TABLE	251
24.1	Comms Table.....	251
24.2	SCADA Table	251
24.2.1	Programmer Address Ranges - Decimal.....	282
24.2.2	Version 2.xx Programmer Addresses - Hexadecimal.....	289
25.	APPENDIX B DEVICENET PARAMETER TABLES.....	296
25.1	IO Re-Mapping Object.....	296
25.2	Application Variables Object.....	297
25.2.1	Table Modification.....	301
26.	APPENDIX C CANOPEN PARAMETER TABLES.....	302
26.1	Manufacturer Object - Pick List.....	302
27.	APPENDIX D VERSION 1.XX PROGRAMMER	306
27.1	Version 1.xx Parameter Tables.....	306
27.1.1	Configuring the Programmer (V1.xx).....	306
27.1.2	To Select, Run, Hold or Reset a Program (V1.xx).....	307
27.1.3	Creating a Program (V1.xx).....	307
27.1.4	To Select, Run, Hold or Reset a Program (Version 1.xx).....	308
27.2	SCADA addresses for Programmer Version 1.xx.....	308
28.	APPENDIX E SAFETY AND EMC INFORMATION	314
29.	APPENDIX F TECHNICAL SPECIFICATION.....	317
29.1	Environmental Specification.....	317
29.2	Network Communications Support.....	317
29.3	Configuration Communications Support.....	317
29.4	Fixed I/O Resources.....	317
29.5	TC8 8-Channel and TC4 4-Channel TC Input Card.....	318
29.6	DO8 8-Channel Digital Output Card.....	318
29.7	RL8 8-Channel Relay Output Card.....	318
29.8	CT3 3-Channel Current-Transformer Input Card.....	319
29.9	Load Failure Detection	319
29.10	DI8 8-Channel Digital Input Card	319
29.11	RT4 Resistance Thermometer Input Card	319
29.12	AO8 8-Channel and AO4 4-Channel 4-20mA Output Card.....	320
29.13	Toolkit Blocks	320
29.14	PID Control Loop Blocks	320
29.15	Process Alarms	321
29.16	Setpoint Programmer.....	321
29.17	Recipes.....	321
30.	PARAMETER INDEX.....	322

Issue Record of This Manual

Issue 6 includes Enhanced Devicenet Communications.

Issue 7 corrects terminal numbers in Example 2 section 7.9.2.1, adds references to iTools in sections 1.4.12 and 1.4.13 and adds to section 10.8 'Note: from July 09 CANopen option has been discontinued'.

Issue 8 clarifies and completes table 1.6.1.1 (Module status indication), and modifies the specification for Digital inputs in sections 29.4 and 29.10.

Issue 9 Section 1.4.7 thin trunk line length changed from 100m to 40m for baud rate of 1M.

Issue 10 adds two parameters 'ServoToPV' and 'SPIntBal' to the Setpoint Parameter List, update to order code, improve fallback description, timer and sample and hold diagrams.

Issue 11 adds EtherNet/IP.

Issue 12 adds the Battery Warning below:

 **Warning**
Back up Battery

This instrument is fitted with a battery designed to retain configuration and other settings in the event of a failure of the instrument power supply.

This battery has an expected life of 10 years minimum at a nominal ambient working temperature (e.g. 25°C).

The battery life may be reduced if it is consistently operated in an elevated ambient temperature environment.

Maintenance Schedule

A battery failure is only evident following a failure of the instrument power supply.

The battery should be replaced at regular intervals. Between 6 and 10 years is recommended depending on usage and operating temperature. The battery is not user serviceable, contact your local service centre to make suitable arrangements.

On older instruments contact your supplier to have the battery replaced prior to failure. The age of the instrument is shown on the side label. This contains a serial number, where the last four characters either show the week number and year of manufacture WW YY, or a date in the format UK YYWW.

It is important to maintain a record of instrument configurations or use Eurotherm iTools to make clone copies of fully working instruments. This is described in section 3.3. Store this securely as a back up to be used to restore the configuration.

Mini8 Multi-Loop Process Controller

1. Chapter 1 Installation and Operation

1.1 What Instrument Do I Have?

Thank you for choosing this Mini 8 Controller.

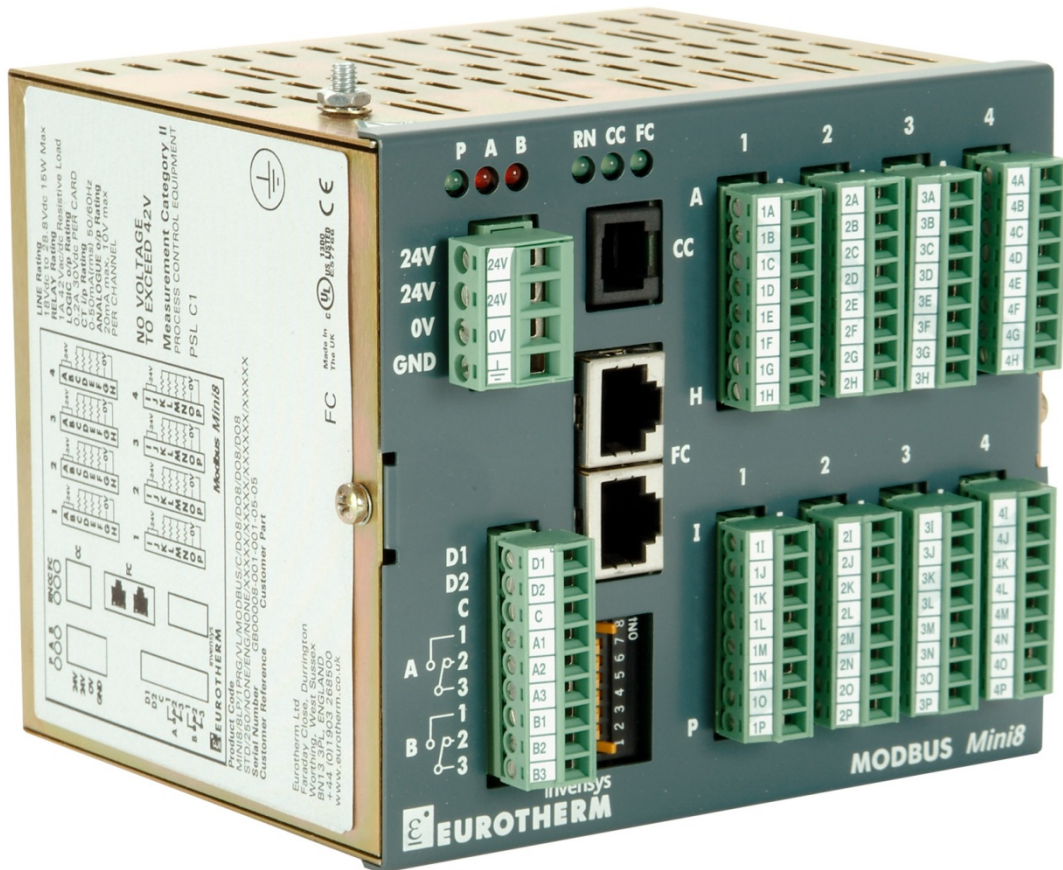

The Mini8 controller is a compact DIN rail mounting multi-loop PID controller and data acquisition unit. It offers a choice of I/O and a choice of field communications.

The Mini8 controller mounts on 35mm Top Hat DIN Rail. It is intended for permanent installation, for indoor use only, and to be enclosed in an electrical panel or cabinet.

The Mini8 controller is pre-assembled in the factory to give the I/O required for the application as specified in the order code. With standard applications the Mini8 controller is also supplied configured. Alternatively, the Mini8 controller is configured using Eurotherm’s iTools configuration suite running on a personal computer.

All Safety & EMC information is in Appendix E.

The full Technical Specification is in Appendix F.

Whenever the symbol ☺ appears in this handbook it indicates a helpful hint

1.3 How to Install the Controller

This instrument is intended for permanent installation, for indoor use only, and to be enclosed in an electrical panel. Select a location where minimum vibrations are present and the ambient temperature is within 0 and 50°C (32 and 122°F).

Please read the safety information, Appendix E at the end of this manual, before proceeding and refer to the EMC Booklet part number HA025497 for further information.

1.3.1 Dimensions

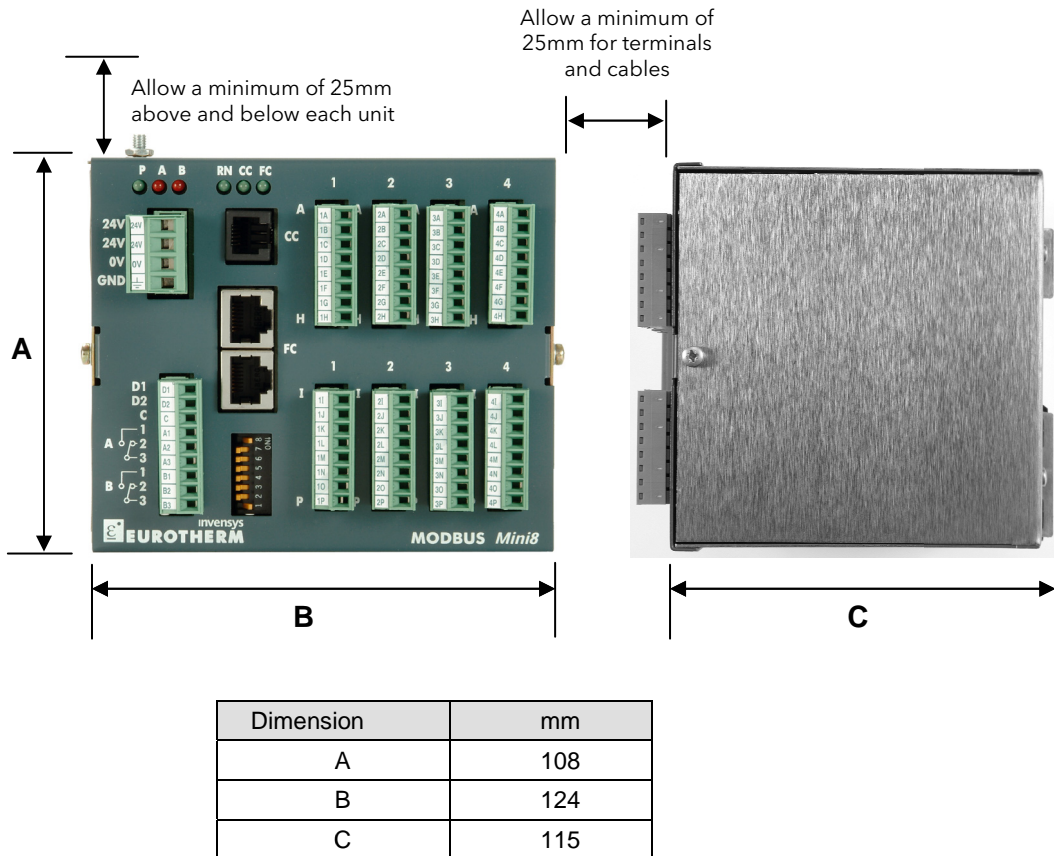

Figure 1-1: Mini8 Controller Dimensions

1.3.2 To Install the Controller

1. Use 35mm symmetrical DIN Rail to EN50022-35 x 7.5 or 35 x 15,
2. Mount the DIN Rail horizontally as indicated in Figure 1.1. The Mini8 controller is NOT designed to be mounted in other orientations.
3. Hook the upper edge of the DIN rail clip on the instrument on the top of the DIN rail and push.
4. To remove use a screwdriver to lever down the lower DIN rail clip and lift forward when the clip has released.
5. A second unit on the same DIN rail may be mounted adjacent to the unit.
6. A second unit mounted above or below the unit requires a gap of at least 25mm between the top of the lower one and the bottom of the higher one.

1.3.3 Environmental Requirements

Mini8 controller	Minimum	Maximum
Temperature	0°C	55°C
Humidity (non condensing)	5% RH	95% RH
Altitude		2000m

1.4 Electrical Connections

The Mini8 controller is intended for operation at safe low voltage levels, except the RL8 relay module. Voltages in excess of 42 volts must not be applied to any terminals other than the RL8 relay module.

A protective earth connection is required.

Do not replace the battery. Return to factory if replacement battery is required.

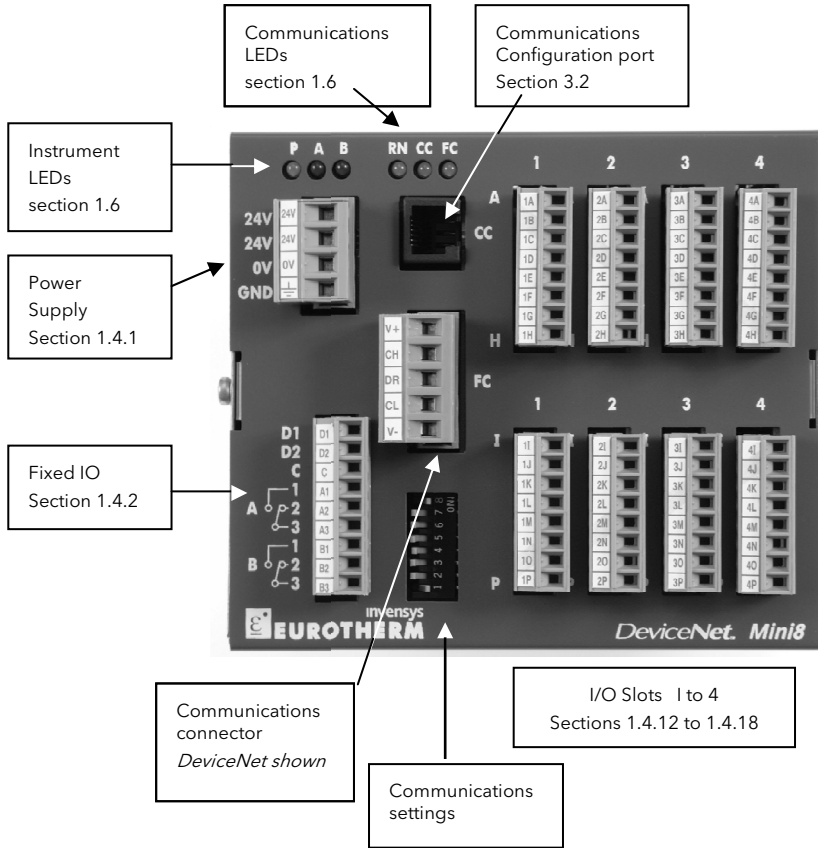
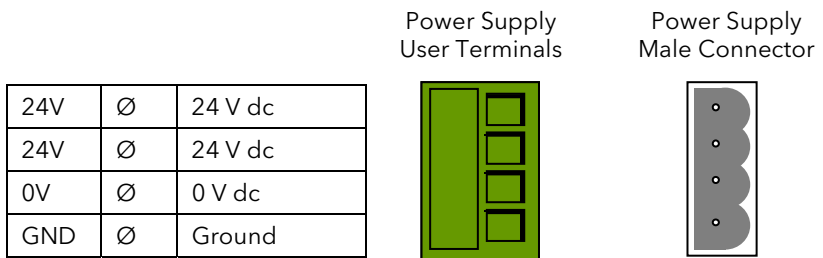

Figure 1-2: Terminal Layout for Mini8 Controller

1.4.1 Power Supply

The power supply requires a supply between 17.8 to 28.8 V dc, 15 watts maximum



Connector terminals will accept wire sizes from 0.2 to 2.5, 24 to 12 awg.

Note: If the Mini8 is used with the VT505 panel ensure that the power supply connectors **cannot** be mistakenly changed over. The connectors are physically the same, but the electrical connections are not compatible. Plugging the connector into the Mini8 controller will short-circuit the 24 volt supply.

1.4.2 Fixed IO Connections

These I/O are part of the power supply board and are always fitted.

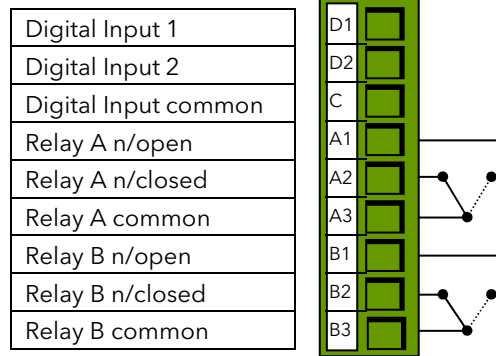

Digital Inputs : ON requires +10.8V to +28.8V.

OFF requires -28.8V to +5V

+5V to +10.8v is undefined

Typical drive 2.5mA at 10.8V.

Relays contacts: 1 amp max, 42Vdc. These contacts are NOT rated for mains operation.

1.4.3 Digital Communications Connections

Two communications connections are fitted - a Modbus Configuration port (RJ11) and a Fieldbus port.

The Fieldbus is either Modbus (2 x RJ45), DeviceNet, CANopen, Profibus, EtherNet Modbus TCP (10baseT) or EtherNet IP.

1.4.4 Configuration Port (CC)

The configuration port (Modbus) is on an RJ11 socket. It is always fitted just to the right of the power supply connections. It is a point to point RS232 connection. Eurotherm supply a standard cable to connect a serial COM port on a computer to the RJ11 socket, part no. **SubMin8/cable/config**.

9 pin DF to PC COM port (RS232)	RJ11 Pin	Function
-	6	N/c
3 (Tx)	5	Rx
2 (Rx)	4	Tx
5 (0v)	3	0v (gnd)
	2	N/c
	1	Reserved

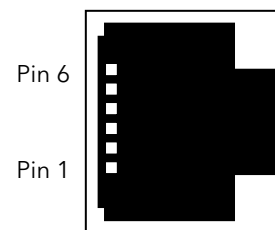

See also section 10.1

1.4.5 Screened Communications Cables

Screened cables should be used. In order to reduce the effects of RF interference the transmission line should be grounded at both ends of the screened cable. However, care must be taken to ensure that differences in earth potentials do not allow circulating currents to flow as these can induce common mode signals in the data lines. Where doubt exists it is recommended that the screen (shield) be grounded at only one section of the network. This applies to all communications protocols.

1.4.6 Modbus

For a full description of the installation of a communications link, including line matching resistors, see Eurotherm 2000 series communications handbook, part no. HA026230.

For Modbus operation see section 10.3.

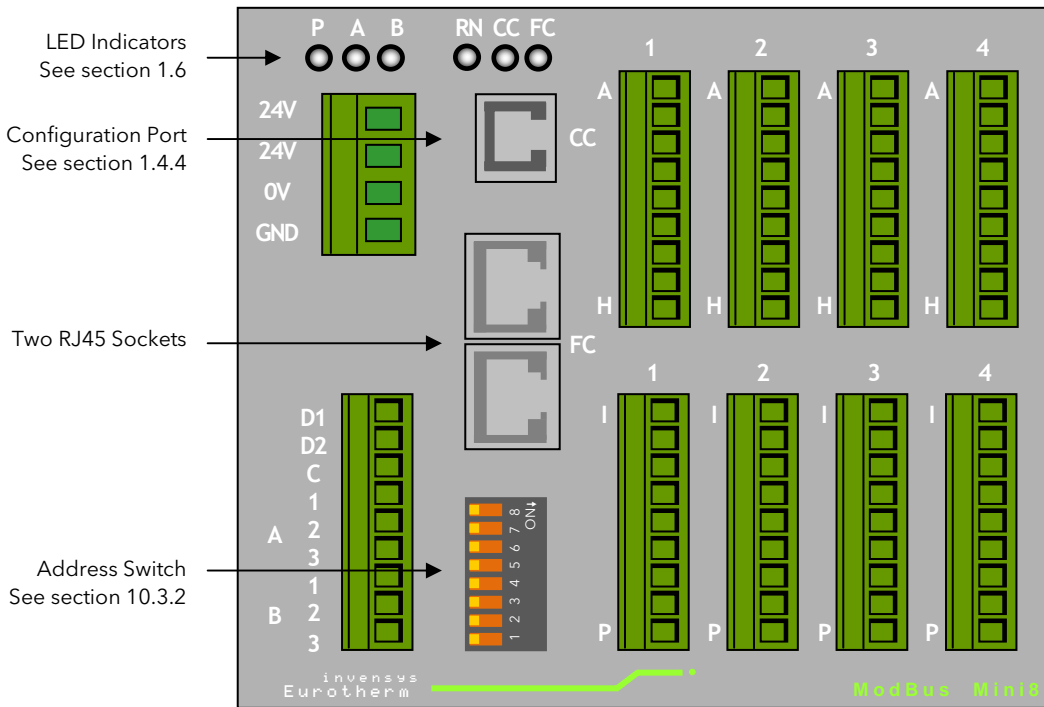
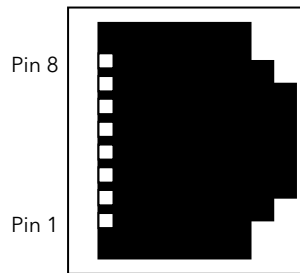

Figure 1-3: Front Panel Layout Modbus

1.4.6.1 Modbus Connectors

Two RJ45 sockets are provided - one for the incoming connection, the second to loop onto the next instrument or for a line terminator, see Figure 1-4.

RJ45 pin	3 wire	5 wire
8	A	RxA
7	B	RxB
6	Ground	Ground
5		
4		
3	Ground	Ground
2	A	TxA
1	B	TxB



The RS485 standard allows one or more instruments to be connected (multi dropped) using a two wire connection, with cable length of less than 1200m. 31 instruments and one master may be connected.

To use RS485, buffer the RS232 port of the PC with a suitable RS232/RS485 converter. The Eurotherm Controls KD485 Communications Adapter unit is recommended for this purpose. The use of a RS485 board built into the computer is not recommended since this board may not be isolated, which may cause noise problems or damage to the computer, and the RX terminals may not be biased correctly for this application.

Either cut a patch cable and connect the open end to the KD485 converter or, using twin screened cable, crimp an RJ45 plug on the Mini8 controller end.

The communication line must be daisy chained from device to device and, if the communications line is more than a metre or two long, it must be correctly terminated. A Modbus terminator containing the correct termination resistors is available from Eurotherm, order code:

SubMini8/RESISTOR/MODBUS/RJ45. The Modbus terminator is BLACK.

See also the 2000 series Communications Handbook, part number HA026230, available on www.eurotherm.co.uk for further information on digital communications.

1.4.6.2 Modbus Interconnections - RS485

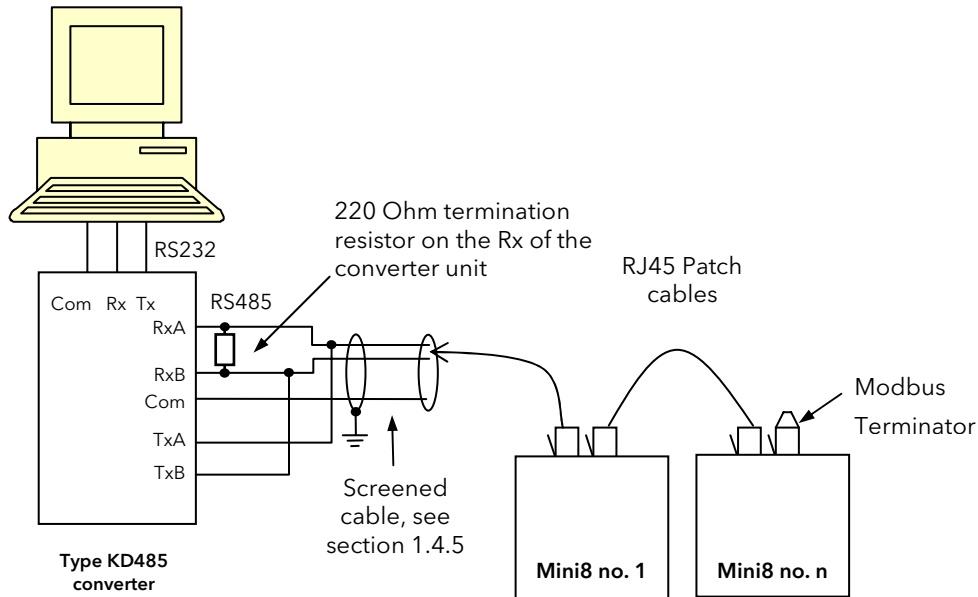

Figure 1-4: RS485 two-wire Connections

For the 4 wire connection the TxA and TxB are not connected to RxA and RxB but connected separately through another twisted pair.

1.4.6.3 Wiring Connections for Modbus Broadcast Communications

The Digital Communications module for the master must be the Field Comms and is only RS485/RS422. RS232 is not available.

The Digital Communications module for the slave can be the Config port (RS232 only) or the Field Comms port (Not RS232).

Standard patch cables cannot be used, as the connections do not 'cross over.' Wire using twisted pair(s) cable and crimp on the appropriate RJ45 or RJ11 plug.

RS485 2-wire

Connect A (+) in the master to A (+) of the slave
 Connect B (-) in the master to B (-) of the slave
 This is shown diagrammatically below

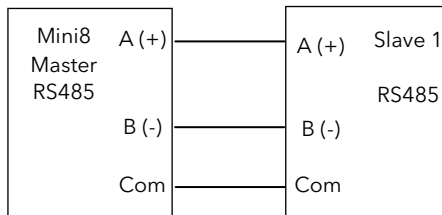

Figure 1-5: Rx/Tx Connections RS485 2-wire

RS422, RS485 4-wire

Rx connections in the master are wired to Tx connections of the slave

Tx connections in the master are wired to Rx connections of the slave

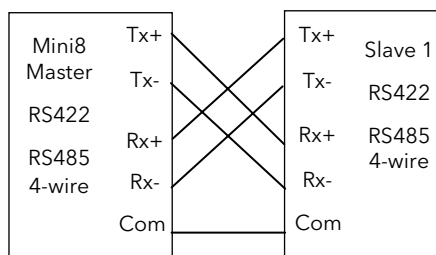

Figure 1-6: Rx/Tx Connections for RS422, RS485 4-wire

1.4.7 DeviceNet / CANopen

Instruments supplied after July 2009 no longer support DeviceNet™ CAN interface, CANopen V4.02 CAN interface and Enhanced DeviceNet™. Information is included here to cover instruments supplied previously with CANopen.

DeviceNet and CANopen both use a 5 way, 5.08mm pitch, connector/screw terminal. The DeviceNet bus is powered (24V) from the system network, not from the instrument. The Mini8 controller requirement is a load of around 100mA. For the address switch see section 10.5.

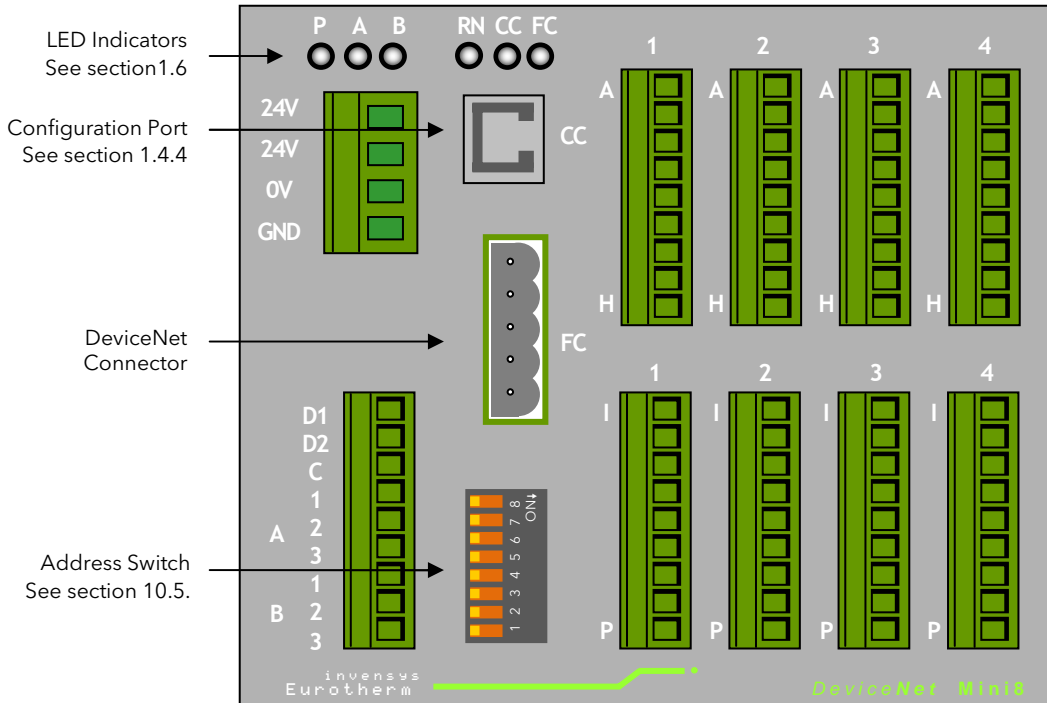

Figure 1-7: Front Panel Layout Devicenet

1.4.7.1 DeviceNet Connector

Pin	Legend	Function
5	V+	V+
4	CH	CAN HIGH
3	DR	DRAIN
2	CL	CAN LOW
1	V-	V-



Mini8 controller Label	Colour	Description
V+	Red	Network power positive terminal. Connect the red wire of the DeviceNet / CANopen cable here. If the network does not supply the power, connect the positive terminal of an external 11-25 Vdc power supply.
CAN_H	White	CAN_H data bus terminal. Connect the white wire of the DeviceNet / CANopen cable here.
SHIELD	None	Shield/Drain wire connection. Connect the DeviceNet cable shield here. To prevent ground loops, the network should be grounded in only one location.
CAN_L	Blue	CAN_L data bus terminal. Connect the blue wire of the DeviceNet / CANopen cable here.
V-	Black	Network power negative terminal. Connect the black wire of the DeviceNet / CANopen cable here. If the DeviceNet network does not supply the power, connect the negative terminal of an external 11-25 Vdc power supply.

The **DeviceNet** specification states that the bus terminators of 121 ohm should not be included as any part of a master or slave. They are not supplied but should be included in the cabling between CAN_H and CAN_L where required.

The **CANopen** Cabling and Connector Pin Assignment specification specifies that the minimum termination resistance is 118 ohm with the following guidelines. They are not supplied but should be included in the cabling where required.

Bus length (m)	Termination resistance (ohms)
0 - 40	124
40 - 100	150 - 300

1.4.7.2 Network Length

Network length depends on Baud rate:-

Network Length	Varies w/speed, up to 4000m possible w/repeaters			
Baud Rate	125	250	500	1M (CANopen)
Thin trunk	100m (328ft)	100m (328ft)	100m (328ft)	40m
Max drop	6m (20ft)	6m (20ft)	6m (20ft)	6m(20ft)
Cumulative drop	156m (512ft)	78m (256ft)	39m (128ft)	19m (64ft)

1.4.7.3 Typical DeviceNet / CANopen Wiring Diagram

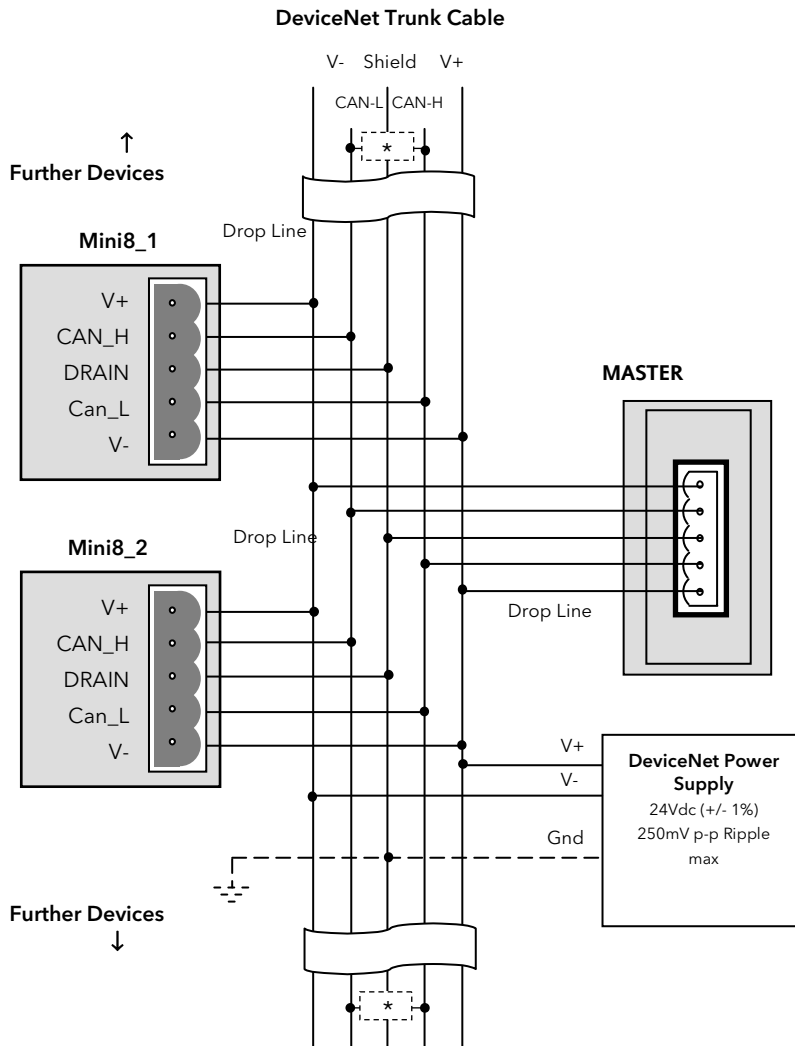

* 121Ω 1% 1/4W terminating resistor must be connected across the blue and white wires at each end of the DeviceNet trunk cable.

Note: this resistor is sometimes included in the master or other devices but should only be switched into circuit on the last device on the trunk cable.

Note:

The DeviceNet network is powered by an external independent 24V supply which is separate from the internal powering of the individual controllers.

Note: Power taps are recommended to connect the DC power supply to the DeviceNet trunk line. Power taps include: A Schottky Diode to connect the power supply V+ and allows for multiple power supplies to be connected.

2 fuses or circuit breakers to protect the bus from excessive current which could damage the cable and connectors.

The earth connection, HF, to be connected to the main supply earth terminal at one point only.

See also the DeviceNet Communications Handbook HA027506

1.4.8 Enhanced DeviceNet Interface

This version of DeviceNet has been added for use in the Semiconductor industry. Configuration for both versions is the same and is described in the DeviceNet Handbook HA027506 which can be downloaded from www.eurotherm.com. The Enhanced DeviceNet interface uses a different connector, as described below, but cabling, cable specification and termination are the same as described in the previous section.

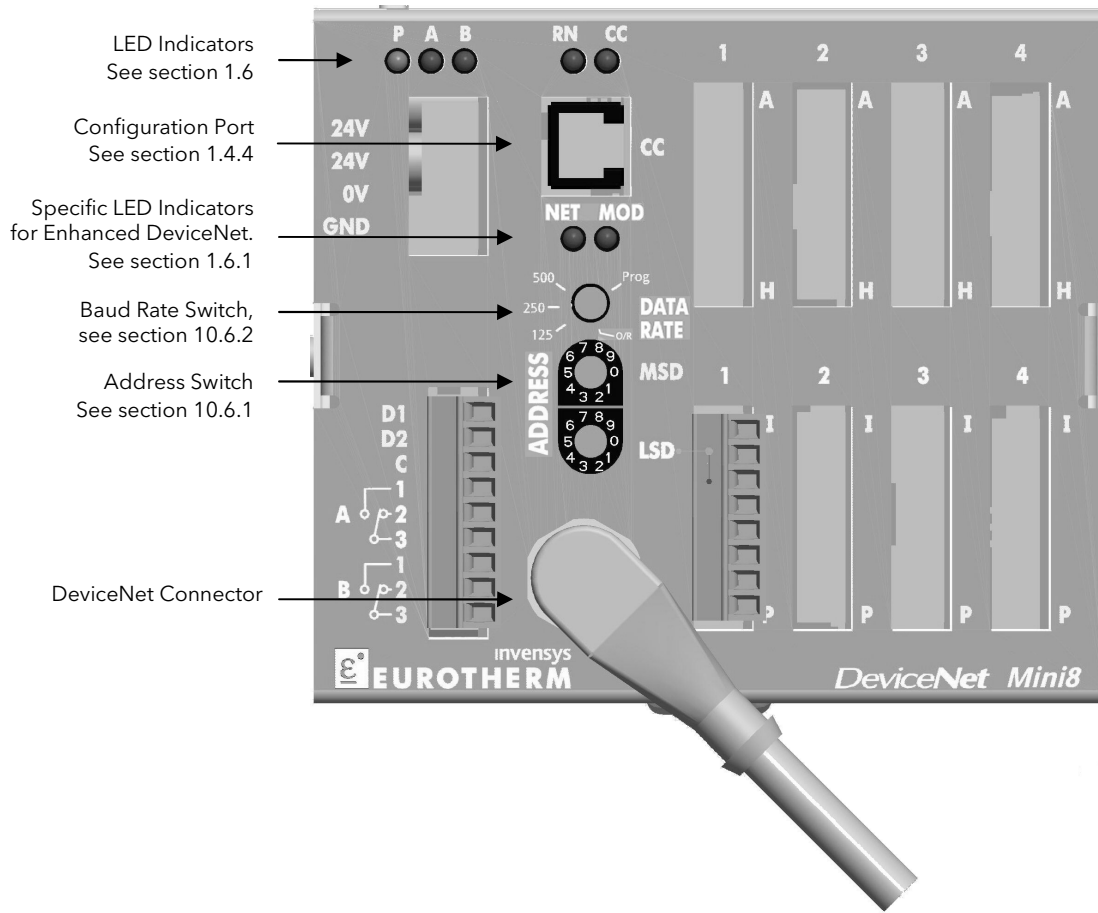
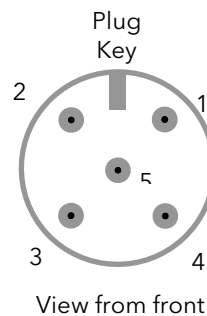

Figure 1-8: Enhanced DeiceNet Panel Layout

1.4.8.1 Enhanced DeviceNet Connector

The 5-way connector shown in the previous section is replaced by a 'Micro-Connect' circular 5-pin M12 male connector mounted in the module.

Pin	Legend	Function
5	CAN_L	CAN LOW
4	CAN_H	CAN HIGH
3	V-	V-
2	V+	V+
1	DR	DRAIN



1.4.8.2 Switches and LED Indicators

The Enhanced DeviceNet interface also uses different Module and Network Status indicators, address and baud rate switches.

To set the Address and Baud Rate, see section 10.6.

For Module and Network Status indication see section 1.6.1.

1.4.9 Profibus DP

Two Profibus communications board options are available for the Mini8 controller.

1. Standard Profibus 3 wire RS485 9 pin D connector intended for installation using standard Profibus cabling. Note that in this arrangement line terminations must be catered for in the cabling.
2. Profibus 3 wire RS485 via 2 paralleled RJ45 sockets. The front panel layout for this version is the same as Modbus (Figure 1-3). Instruments may be daisy chained using suitable RJ45 cables and an RJ45 termination plug is available to terminate the line.

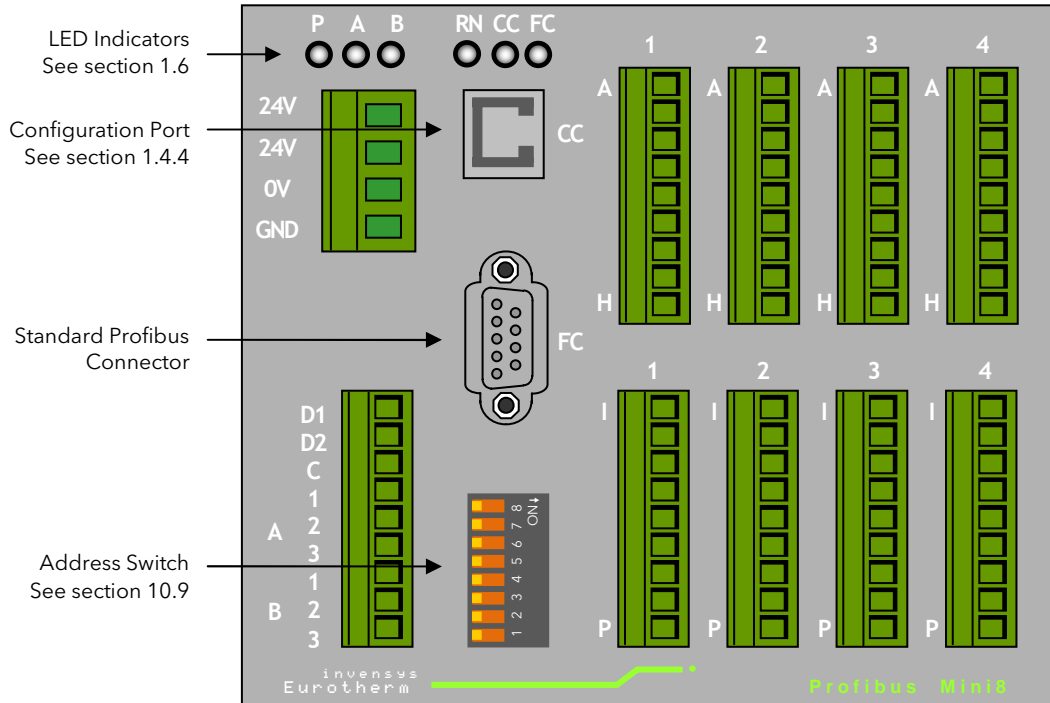
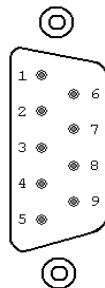

Figure 1-9: Profibus Panel Layout - Standard D Connector

1.4.9.1 Profibus Interface (D-Type Connector)

Connector: 9-Way D-Type, R/A, Female, 4-40 UNC Studs:

Pin	Function
1	Shield (Case)
2	N/C
3	RxD/TxD+ P (B)
4	N/C
5	GND (0V)
6	VP (+5V)
7	N/C
8	RxD/TxD- N (A)
9	N/C



Terminations must be included in the cabling.

1.4.9.2 Profibus Interface (RJ45 Connector)

Connector: Two RJ45, parallel connected (for daisy-chain):

Pin	3-Wire
8	(do not use)
7	(do not use)
6	VP (+5V)
5	
4	
3	GND
2	RxD/TxD+ P (B)
1	RxD/TxD- N (A)

One connector may be used to terminate line using SubMini8/Term/Profibus/RJ45. This terminator is grey.

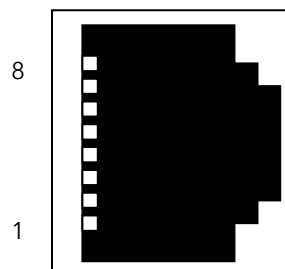

1.4.10 EtherNet (Modbus TCP)

The EtherNet connection uses standard Cat5E patch cables (RJ45). These would be used with a 10BaseT hub to create a network.

A crossover patch cable may be used 'point-to-point' i.e. to connect a single instrument directly to a PC.

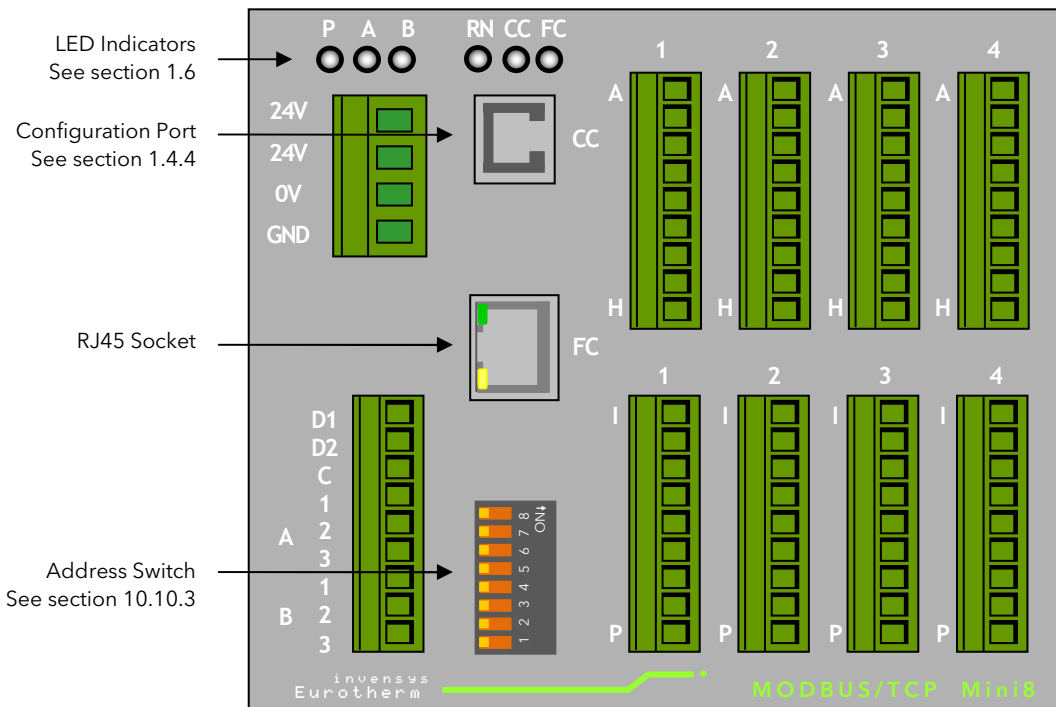
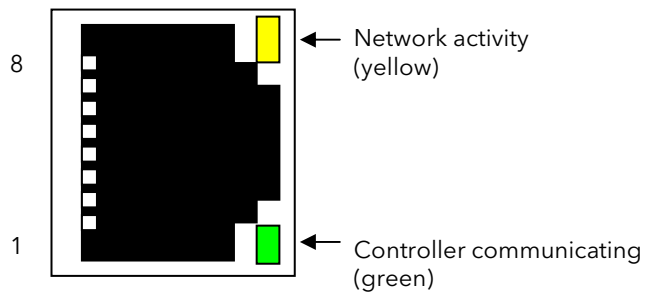

Figure 1-10: EtherNet TCP Front Panel Layout

1.4.10.1 Connector: RJ45:

Pin	Function
8	
7	
6	RX-
5	
4	
3	RX+
2	TX-
1	TX+



1.4.11 EtherNet/IP

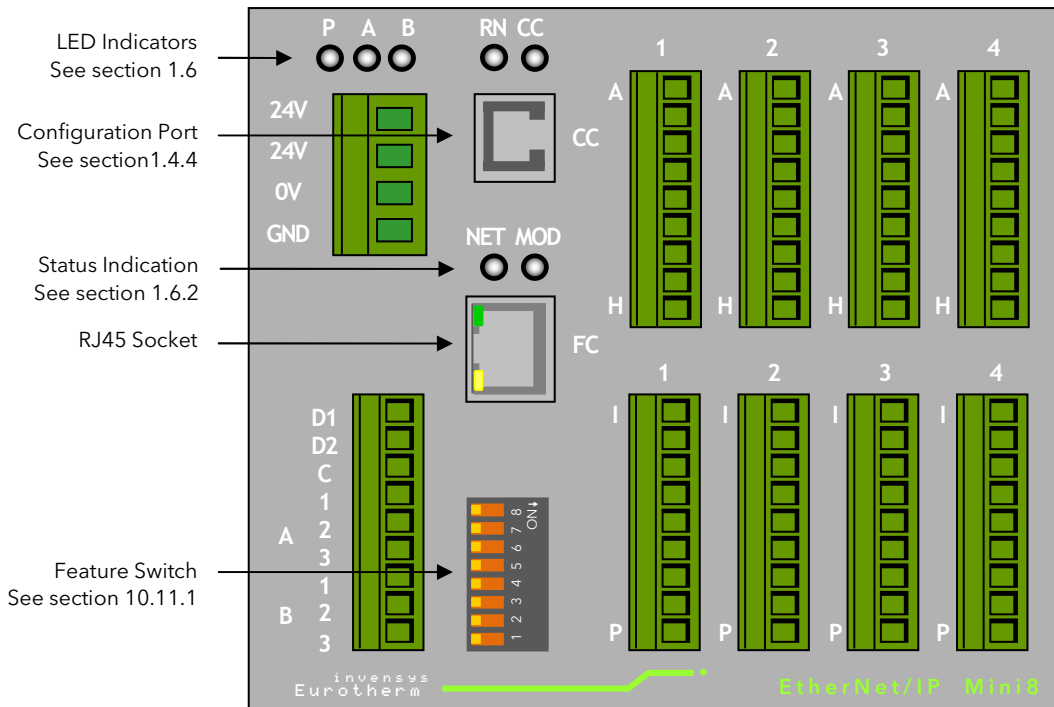
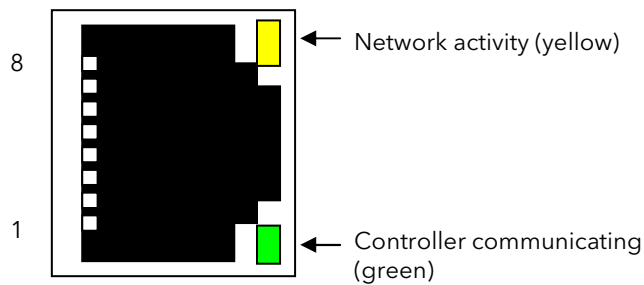

Figure 1-11: EtherNet/IP Front Panel Layout

1.4.11.1 Connector: RJ45:

This is the same as the connector shown above in section 1.4.10

Pin	Function
8	
7	
6	RX-
5	
4	
3	RX+
2	TX-
1	TX+



Note: Screened cable should be used, see section 1.4.5 for further details.

1.4.12 Thermocouple Input TC4 and TC8

The TC8 thermocouple module takes 8 thermocouples.
 The TC4 module takes 4 thermocouples.
 They may be placed in any slot in the Mini8 controller.
 Up to 4 modules may be fitted in a Mini8 controller.
 Each input can be configured to any thermocouple type or a linear mV input.

Note: Configuration of Mini8 Controller is performed using 'iTools' configuration suite running on a personal computer.
 See subsequent chapters in this manual and specifically example 1 given in section 3.5.1 for further information.
 The TC4 module offers TC1 to TC4, on terminals A to H.

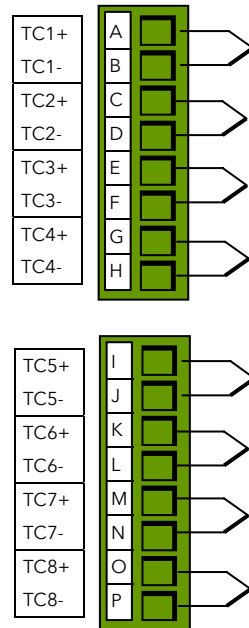

1.4.13 RTD / PT100 Input RT4

The RT4 module provides 4 RTD inputs for 2, 3 or 4 wire connections.
 Up to 4 modules may be fitted in a Mini8 controller and they may be placed in any slot.
 Each input can be configured for any resistive sensor up to 600 ohms. Standard linearisation is available for PT100.

Note: Configuration of Mini8 Controller is performed using 'iTools' configuration suite running on a personal computer.
 See subsequent chapters in this manual and specifically example 2 given in section 3.5.1 for further information.

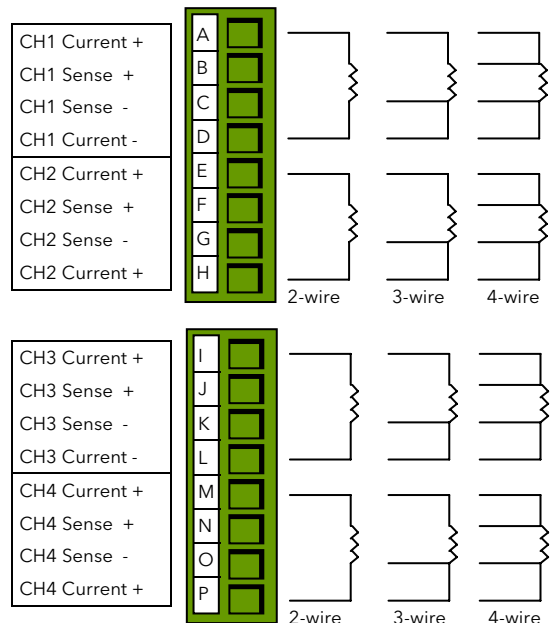

☺ Tip:

Spare RT4 input channels may be configured as mA inputs using a 2.49 ohm resistor, order code SubMini8/resistor/Shunt/249R.1.

See section 7.6.3 for configuration.

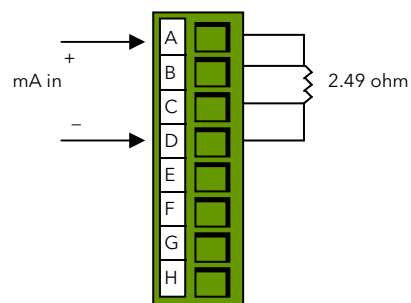

1.4.14 Logic Input DI8

The DI8 module provides 8 logic inputs.
They may be placed in any slot in the Mini8 controller.
Up to 4 modules may be fitted in a Mini8 controller.

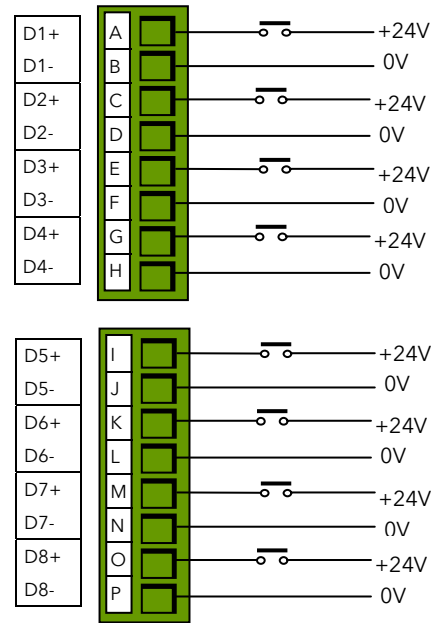

Digital Inputs : ON requires +10.8V to +28.8V.
OFF requires -28.8V to +5V
+5V to +10.8v is undefined
Typical drive 2.5mA at 10.8V.

1.4.15 Logic Output DO8

The DO8 module provides 8 logic outputs.
They may be placed in any slot in the Mini8 controller.
Up to 4 may be fitted in a Mini8 controller.
Each output can be configured to Time Proportioning or On/Off.

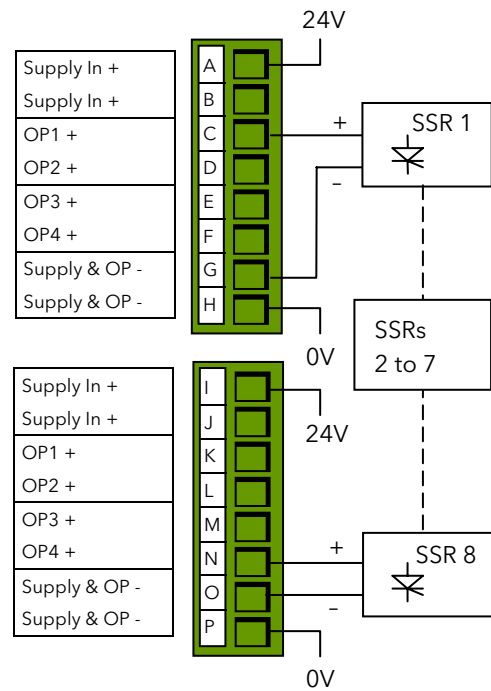

Supply In + (A,B,I,J) are all linked internally.
Supply In - (G,H,O,P) are all linked internally.

1.4.16 Relay Output RL8

The RL8 module provides 8 relay outputs.

Up to 2 modules may be fitted and in slots 2 and/or 3 only

Relay contacts for full contact life:

Maximum 264V ac 2amps with snubber fitted.

Minimum 5V dc, 10mA

Snubbers are used to prolong the life of relay contacts and to reduce interference when switching inductive devices such as contactors or solenoid valves. If the relay is used to switch a device with a high impedance input, no snubber is necessary.

All relay modules are fitted internally with a snubber since these are generally required to switch inductive devices. However, snubbers pass 0.6mA at 110V and 1.2mA at 230Vac, which may be sufficient to hold on high impedance loads. If this type of device is used it will be necessary to remove the snubber from the circuit.

The relay module has to be removed from the instrument, see section 1.5. The snubber is removed from the relay module by inserting a screwdriver into one of the pair of slots either side of the track of each snubber network. Twist the screwdriver to break out this track between the slots.

This action is not reversible.

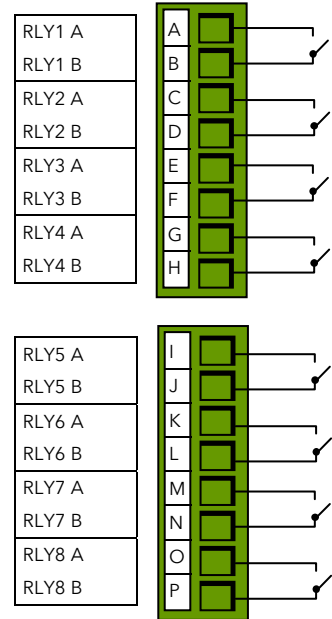

1.4.17 Analogue Output AO4 and AO8

The AO8 modules provides 8 analogue outputs and the AO4 provides 4 analogue outputs.

Each output is configurable within 0 to 20 mA , max load 360 ohm.

The AO4 offers OP1 to OP4 on terminals A to H.

Only one module may be fitted and in slot 4 only.

☺ Tip:

A 0 to 10 volt output can be obtained by scaling the drive to 0 to 10mA and fitting an external 1kohm resistor (for example). Low load impedance may alter the results but this can be corrected by adjusting the output range accordingly.

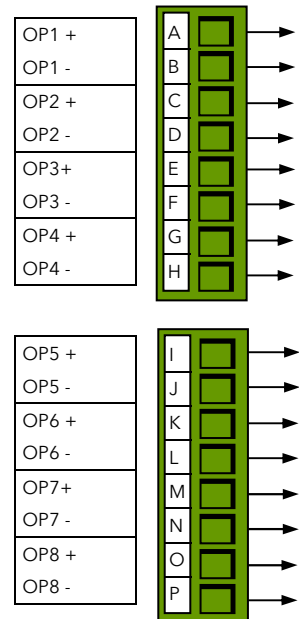

1.4.18 Current Transformer Input Module CT3

This provides inputs for 3 current transformers.
 The heater load cables are threaded through the transformers.
 Each input is 50mA max into 5 ohms.

The current transformers provide channel isolation; there is no channel to channel isolation in the module.

It is recommended that the current transformer is fitted with a voltage limiting device such as two back to back zener diodes between 3 and 10 volts, rated for 50mA.

There are 3 CT inputs, one for each phase. Up to a maximum of 16 heaters may be threaded through the CTs but with a further limit of 6 heater wires through each individual CT.

See Section 7.9 for typical circuit arrangements.

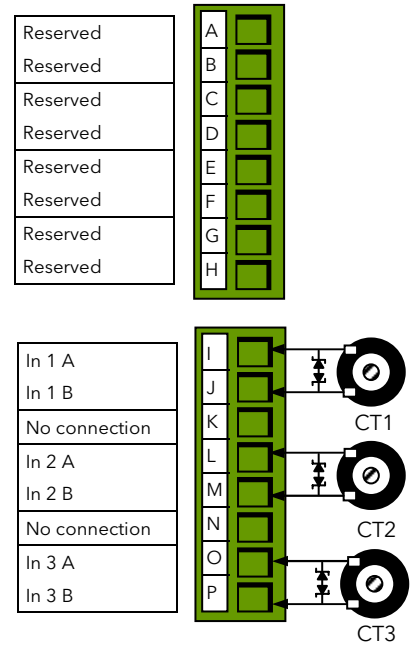

1.5 Adding or Replacing an IO Module.

Modules contain static sensitive electronic devices. Take full antistatic protection when replacing modules by working on an earthed mat with an earthed wrist strap. Avoid touching components, keep fingers on the green connectors or the edge of the printed circuit boards.

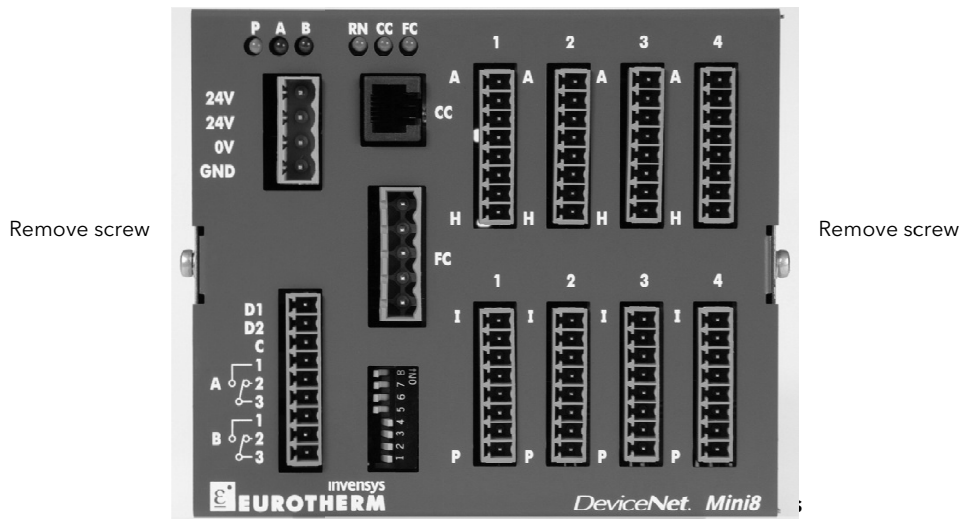

1. Remove all connectors.
2. Remove the 2 screws indicated above
3. Remove the cover.
4. If removing a module gently prise it out using the green connectors.
5. Insert the new module carefully using the guides on the side of the case to help to line up the lower connector with its mate on the motherboard. This requires great care as the guides provide mechanical support rather than being plug in guides.
6. Once you are certain the two connectors are lined up, push the module **gently** into place. Do NOT force.
7. Replace cover and the 2 cover screws.
8. Replace all connectors onto their correct modules.

1.6 Mini8 Controller LED Indicators

Two sets of 3 LED indicators on the front panel indicate the power, the state of the output relays, the status of the Mini8 controller and communications activity. LEDs P, A, B, RN, CC are common to all Mini8 controllers. FC is replaced by Network and Module Status LEDs when DeviceNet or EtherNet/IP communications modules are fitted.

Legend	P	A	B
LED	Green	Red	Red
Function	Indicates 24V	Relay A state	Relay B state
OFF	No power	De-energised	De-energised
ON	Powered	Energised	Energised

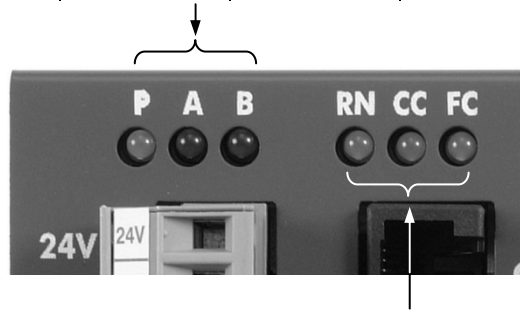

Legend	RN	CC	FC		
			Modbus/Profibus	DeviceNet/CANopen	Ethernet*
LED	Green	Green	Green	Green	Green
Function	Indicates run mode	Indicates Configuration	Field comms activity	Status	Field comms activity
OFF	Not running	--	Offline	Offline	No port traffic
Blinking	Standby	Config traffic	Traffic	Ready	Port traffic excluding local housekeeping
ON	Running	--		Connected	

Note: The EtherNet connector itself has two in-built LEDs (sections 1.4.10 and 1.4.11):

Green = network activity

Yellow = Mini8 controller communicating

The Mini8 controller is controlling normally ONLY if the green RN LED is permanently ON.

Note: In iTools the parameter 'Comms Network Status' is available enumerated as shown in the following table. The enumerations correspond to the FC indicator as shown in the final column:-

'Status' Parameter Enumeration	Meaning	Corresponding FC LED
RUNNING (0)	Network connected and running	On
INIT (1)	Network initialising	Off
READY (2)	DeviceNet traffic detected but not for this address	Blinking
OFFLINE (3)	No DeviceNet traffic detected	Off

1.6.1 Status Indication for Enhanced DeviceNet

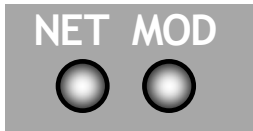

If an Enhanced DeviceNet module is fitted (section 1.4.8), two bi-colour LEDs are used to indicate Module and Network status.

These two LEDs replace the single LED shown as FC on other modules. See previous section.

1.6.1.1 Module Status Indication

The module status LED (MOD) has the functionality shown below:

LED State	Device State	Description
OFF	Off	No power applied to DeviceNet network.
Green/Red flashing	Self test	Irregular flash: LED power-up test. Regular flash: Interface module initialising. If the LED remains in this flashing state indefinitely, check the Baud rate switch setting.
Green ON	Operational	DeviceNet interface is operational.
Red ON	Unrecoverable fault	Mini8 Controller not powered. Nvol checksum failure.
Red/off flashing	Recoverable fault	Communications error between the network and the DeviceNet module.

1.6.1.2 Network Status Indication

The network status LED (NET) indicates the status of the DeviceNet communications link as shown in the table below.

Note: The final column shows the enumerated values for the 'Comms Network Status' parameter available in iTools.

LED State	Network State	Description	'Status' Parameter Enumerations
OFF	Off	Module is not on line	OFFLINE (10)
Green flashing	On-line, not connected	Module is on line but has no connections established	READY (11)
Green ON	On-line and connected	Module is on line and has connections established	ONLINE (12)
Red flashing	Connection timed out	One or more connections have timed out	IO TIMEOUT (13)
Red ON	Critical link failure	Communication error that has rendered the device incapable of communicating on the network	LINK FAIL (14)
Green/Red	Communications fault	Communications fault but the device has received an Identify Communication Faulted Request	COMM FAULT (15)

1.6.2 Status Indication for EtherNet/IP

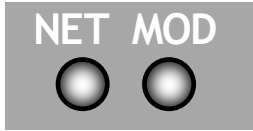

If an EtherNet/IP module is fitted (section 1.4.11) two bi-colour LEDs are used to indicate Module and Network status.

These two LEDs replace the single LED shown as FC on other modules. See previous section.

1.6.2.1 Module Status Indication

The module status LED (MOD) has the functionality shown below:

MOD LED State	Description
OFF	Module has no power
Flashing green	Module is not configured
Steady green	Module is on line and operating correctly
Flashing red	Module has minor ⁽¹⁾ recoverable fault
Steady red	Module has a major ⁽²⁾ non-recoverable fault
Flashing green and red	Module is performing power up testing

Note (1): MOD LED minor faults include the following:-

- DHCP server is unavailable
- Ethernet link is lost.
- Invalid sub net mask.
- Invalid IP Address.
- Error on an Explicit message. E.g. bad parameter address, writing to a read only parameter.

Note (2): MOD LED major fault:-

- Internal fault - return to your supplier for service

1.6.2.2 Network Status Indication

The network status LED (NET) indicates the status of the EtherNet/IP communications link as shown in the table below.

Note: The final column shows the enumerated values for the 'Comms Network Status' parameter available in iTools.

NET LED State	Mnemonic	Description	'Status' Parameter Enumerations
OFF	Off	Module is not on line	20 OffLine
Flashing Green	No connections	Module is on line but has no EtherNet/IP connections established	21 NoConns
Steady Green	Online	Module is on line and has at least one EtherNet/IP connection established	22 OnLine
Flashing Red	Connection timeout	A connection has timed out	23 Timeout
Steady Red	Duplicate IP	A duplicate IP address has been detected	24 DuplIP
Flashing Green/Red	Initialisation	Module is initialising	25 Init

2. Chapter 2 Using the Mini8 controller

The Mini8 controller does not have a display. The only means of configuring it, and of interfacing with it during normal operation is via digital communications.

The auxiliary communications port **CC** (RJ11) gives a Modbus interface, usually connected to iTools, for configuration and commissioning.

The main communications port, **FC**, offers Modbus, DeviceNet, CANopen, Profibus, EtherNet TCP or EtherNet/IP and is normally connected to the system of which the Mini8 controller is a part. It is the means by which the Mini8 controller is operated.

Below are ways the Mini8 controller may be used in a system. iTools is the best PC based solution. The Modbus single register addressing is best for Operator panels, PLCs where floating point may not be available or necessary. Some parameters may also be read this way as floats or long integers.

2.1 iTools

iTools offers a pc based solution. The iTools suite allows configuration, commissioning, trend graphs and logging with OPC Scope, Program Editing, Recipes and User pages with View Builder.

2.1.1 iTools OPC Open server

With an OPEN OPC server running on a PC all the Mini8 controller parameters are available to any third party package with an OPC client. The advantage of this is that all the parameters are addressed by name - the iTools OPC server handles all the physical communication addresses. An example would be with Wonderware InTouch using OPCLink. In this situation the user would not have to know any of the parameter addresses, and would just select a parameter by browsing through the namespace.

e.g. Eurotherm.ModbusServer.1.COM1.ID001-Mini8.Loop.1.Main.PV.

2.2 Modbus, single register, SCADA addressing

The key parameters of the Mini8 controller are available at a fixed single 16 bit register address, independent of its configuration. These can be used with any device with a serial Modbus master. The parameters are listed in full with their addresses in Appendix A.

By default iTools displays the SCADA address of those parameters which are available.

Name	Description	Address	Value
Ident	Channel Ident		TcInput (6)
IOType	IO Type		ThermoCouple (11)
LinType	Linearisation Type		K (1)
SBrkAlarm	Sensor break alarm		Off (0)
AlarmAck	Sensor break alarm acknowledge	4260	No (0)
FilterTimeCo	Filter Time Constant		1s 600ms ...
MeasuredV	Measured Value		1.23
PV	Process Variable	4228	30.56
Offset	PV Offset		0.00
CJCTemp	CJC Temperature		30.51
SBrkValue	Sensorbreak Value		0.08
Status	Status		OK (0)

As shown, not all the parameters within the instrument are available. If other parameters are required they can be obtained by using the **Commstab** folder. This allows up to 250 other parameters to be made available using indirection addressing. This is explained in Appendix A.

Also note that in this area the resolution (number of decimal points) has to be configured and the serial Master has to scale the parameter correctly.

2.3 Modbus (Floating Point)

If the application requires the extra resolution, the **Commstab** folder also offers an alternative solution where a parameter can be indirectly addressed and communicated either as a floating point or as a double integer value - its 'Native' format. This can be used with any device e.g. PC or plc, with a serial Modbus master, able to decode a double register for floating point numbers and long integers. See Appendix A.

2.4 Fieldbus

The Mini8 controller may be ordered with the option of DeviceNet, Profibus, CanOPEN or EtherNet/IP.

DeviceNet comes pre-configured with the key parameters of 8 PID loops and alarms (60 input parameters process variables, alarm status etc and 60 output parameters - setpoints etc.). Loops 9-16 are not included in the DeviceNet tables as there are insufficient attributes for the DeviceNet parameters. See Appendix B.

CANopen offers 4 receive & 4 Transmit PDOs and 1 server SDO with a 200 parameter pick list. See Appendix C

Profibus is set up using a GSD editor included on the iTools CD. The GSD editor sets up the instrument parameters that are required to be communicated with the master.

2.5 EtherNet (Modbus TCP)

The Mini8 controller may be ordered with an EtherNet connection (10baseT) running ModbusTCP as the protocol. An instrument can therefore have a unique identity on the EtherNet network as well as a unique Modbus address for the Modbus master.

2.6 Mini8 Controller Execution

The nominal update of all inputs and function blocks is 110ms. However, in complex applications the Mini8 controller will automatically extend this time in multiples of 110ms.

For example, eight simple heat/cool loops each with two alarms (40 wires) will run at 110ms, while the full EC8 configuration will run at 220ms because of the extra wiring and functionality.

The communications traffic will also have some effect on the update rate.

For example, an application using every function block and all 250 wires will run at 220ms with light communications traffic but may be slowed to 330ms with heavy traffic.

Note that as loading changes, the sample rate may increase or decrease automatically. In order to recover to a faster sample rate, the Mini8 controller must be running consistently with processing power to spare for at least 30s.

2.7 The iTools Operator Interface

Much of this manual is about configuring the Mini8 controller with iTools. However iTools also provides an excellent commissioning tool and can be used as a long-term operator view if convenient.

First it is necessary to go 'on-line' to the Mini8 controller(s). This assumes the communication ports have been wired up to the COM port on the iTools computer (Chapter 10).

2.7.1 Scanning

Open iTools and, with the controller connected, press  on the iTools menu bar. iTools will search the communications ports for recognisable instruments. Controllers connected using the RJ11 configuration port or with the configuration clip (CPI), may be found at address 255 (as a single point to point connection) or on a multidrop RS485 or RS422 network will be found at the address configured in the controller.

The iTools handbook, part no. HA028838, provides further step by step instructions on the general operation of iTools. This and the iTools software may be downloaded from www.eurotherm.co.uk.

When an instrument is found on the network it will be shown as, for example

'COM1.ID001-Mini8' which represents <computer com port>.ID<instrument address>-<Instrument type>

Stop the scan once all the instruments have been found.

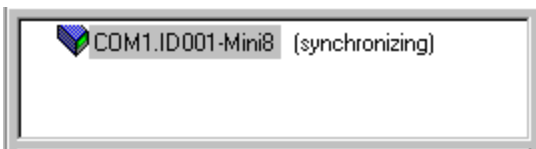

Once an instrument is found on the network a message "sync pending" or "synchronizing" is displayed next to it whilst iTools extracts the exact configuration from the instrument. Wait until this message disappears.

2.7.2 Browsing and Changing Parameter Values

Once the instrument is synchronized the parameter navigation tree is displayed. The contents of this tree will vary depending on the actual configuration of the instrument.

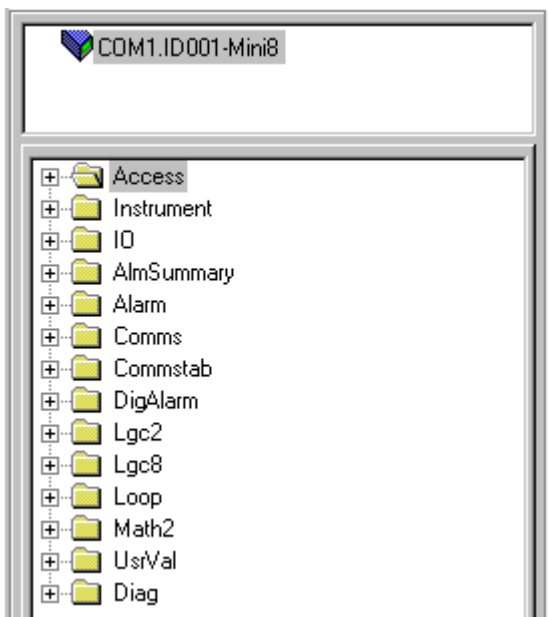

The folders shown will be some of those which are always present -

e.g Instrument, IO, Comms, Access

as well as the configuration dependent ones-

e.g. Loops, Alarm, Lgc2 etc. which have been configured.

To view or change a parameter:

1. Highlight the folder
2. Press  Parameter Explorer to get the parameter window or open up the parameter list by clicking on the required folder. Right click in the parameter list to reveal or hide columns.
3. To change the value of a parameter,
 - a. click the parameter value,
 - b. write in the new value. Note a pop-up window indicates the current value, and the high and low limits.
 - c. Hit <Enter> to enter the new value or <Escape> to cancel.

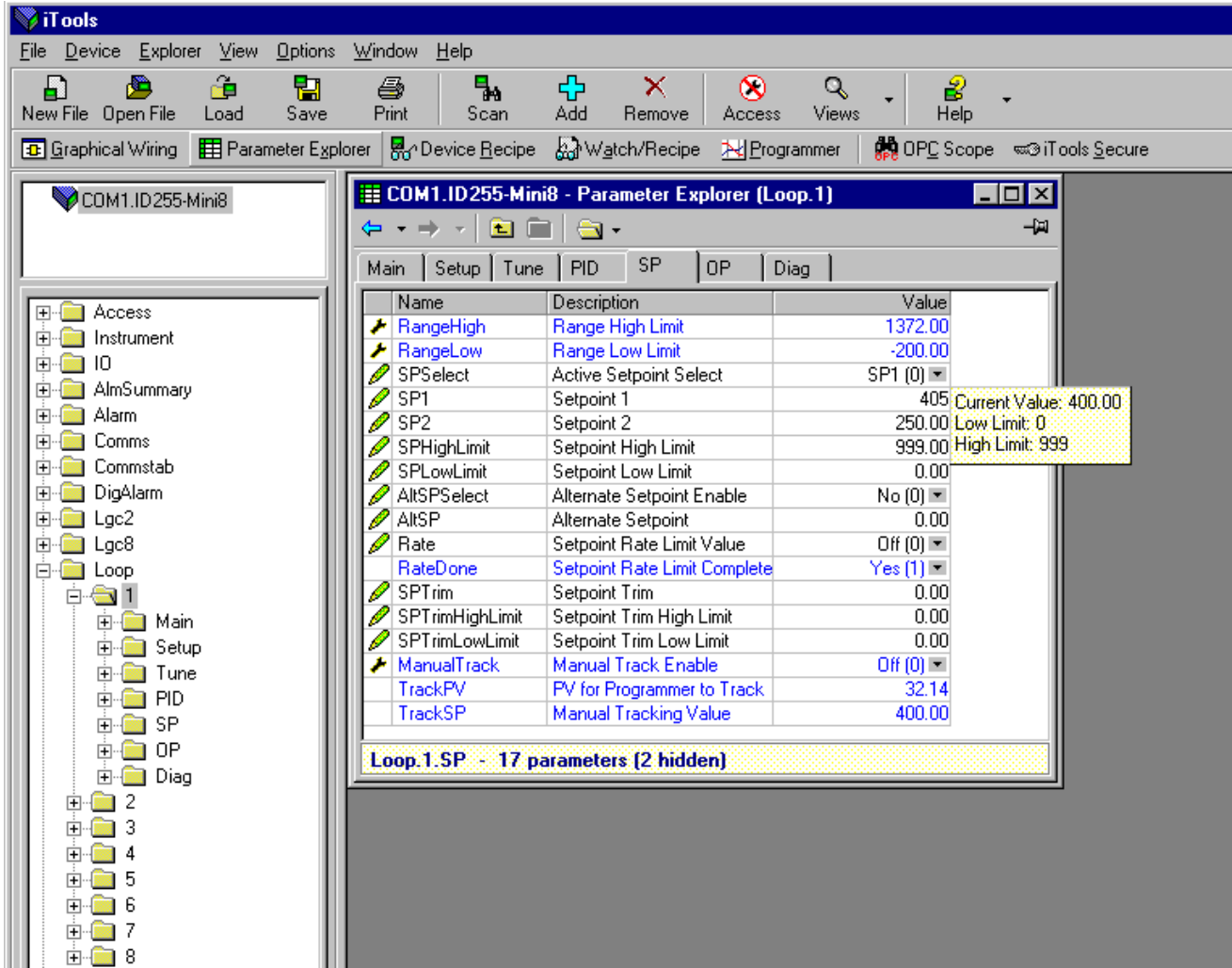

The 'Access' button puts the controller into configuration mode. In this mode the controller can be set up without its outputs being active. Press 'Access' again to return to operating level.

To find a parameter use the 'Find' tab at the bottom of the folder list.

☺ Tip: In parameter lists: Parameters in BLUE are read only
Parameters in BLACK are read/write.

☺ Tip: Every parameter in the parameter lists has a detailed description in the help file - just click on a parameter and hit Shift-F1 on the keyboard or right click and select parameter help.

2.8 Recipe Editor

Press  for this feature. Up to 8 recipes can be stored. They can also be named by the user. Recipes allow the operator to change the operating values of up to 24 parameters in an instrument for different batch items/processes by simply selecting a particular recipe to load. Recipes are important for reducing error in setup and they remove the need for operator instructions fixed to the panel next to the instrument.

Note: Loading a recipe set causes the instrument to enter Standby mode momentarily during which time it does not control.

The Recipe Editor is used during configuration to assign the required parameters and to set up the values to be loaded for each recipe.

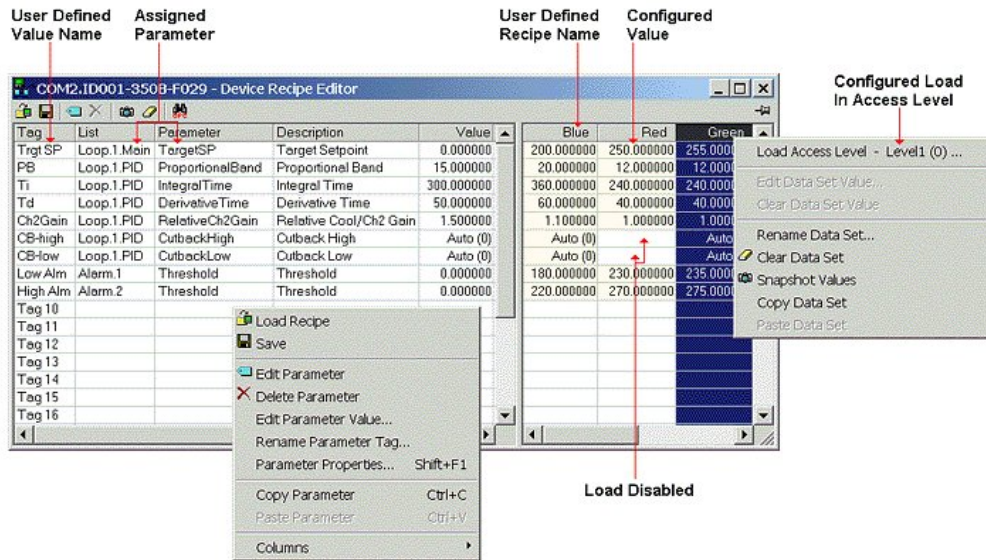

2.8.1 Recipe Menu Commands

Command	Description
Load Recipe	Used to load a recipe file into the instrument
Save	Used to save the current recipe configuration into a file
Edit Parameter	Used to assign a parameter to a Tag. Parameters can also be assigned by 'drag and drop' from the iTools parameter list
Delete Parameter	Used to delete an assigned parameter from the recipes
Edit Parameter Value	Used to edit the current value of the assigned parameter
Rename Parameter Tag	Allows the user to rename the Tag of the associated parameter. This tag is used on the instrument to identify assigned parameters (default Value1 - Value24)
Parameter Properties	Used to find the properties and help information of the selected parameter
Copy Parameter	Used to copy the currently selected parameter
Paste Parameter	Used to assign a previously copied parameter to the selected Tag
Columns	Used to hide/show the Description and Comment Columns
Load Access Level	Used to configure the lowest access level in which the selected recipe is allowed to load
Level1	Permitted to load when the instrument is in any of the access levels
Config	Permitted to load when the instrument is in the Config access level
Never	Never permitted to load
Edit Data Set Value	Used to edit the value of the selected assigned parameter within the selected recipe. Values can also be edited via double left clicking the value itself
Clear Data Set Value	Used to clear the value of the selected assigned parameter within the selected recipe, thus disabling it from loading when the recipe is selected to load
Rename Data Set	Allows the user to rename the selected recipe. This name is used to identify individual recipes (default Set1 - Set8). Note: Number of recipes dependent upon features
Clear Data Set	Used to clear all values in the selected recipe, thus disabling all from loading when the recipe is selected to load
Snapshot Values 	Used to copy all of the assigned parameters current values into the selected recipe
Copy Data Set	Used to copy all values of the selected recipe
Paste Data Set	Used to paste all values of a previously copied recipe into the selected recipe

2.9 OPCScope

OPC scope is a standalone OPC client that can be used to attach to the iTools OPCserver. It offers real time trend charts and data logging to disc in a .csv (comma separated variable) format which can easily be opened by a spreadsheet such as Excel.

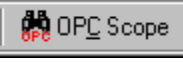
With iTools open OPC Scope can be started using the icon 

But it can also be started on its own using the Windows Start/Programs/Eurotherm iTools/OPC Scope

Select Server/Connect or click the icon  and the OPC server will start up (if it is not running) and will display the active ports on the computer. Opening the COM port will show the attached instruments as shown below.

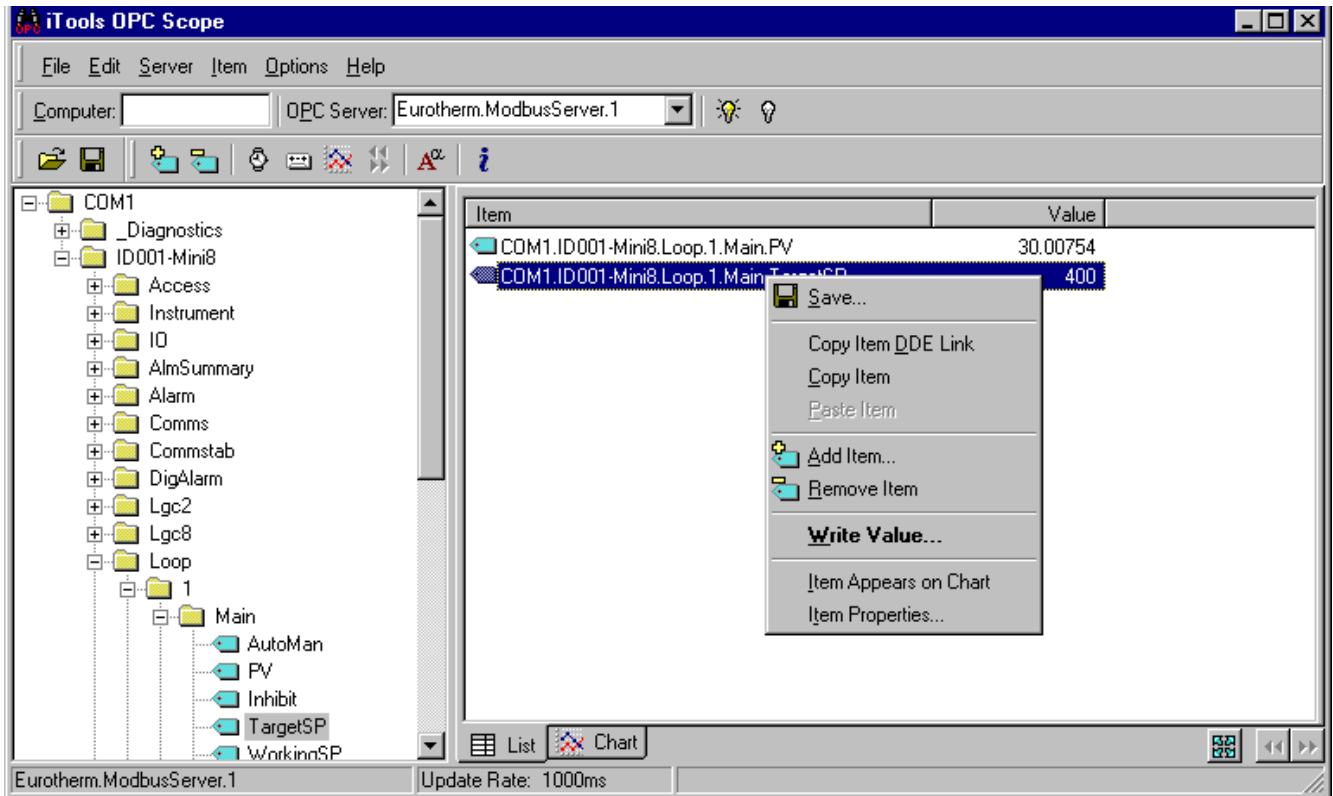

The 'ID001-Mini8' folder will contain all the same folders for the instrument that would have been seen in iTools itself. Expand the folder and double click on the blue item tag to add to the List Window. The List Window shows all the selected parameters and their current value.

Right click on a parameter to get the context menu.

2.9.1 OPC Scope List Window Context Menu

Command	Description
Save	Saves the OPC Scope configuration as <filename>.uix See Section 2.9.3
Copy Item DDE link	Saves the DDE path to the clipboard. 'Paste Special' in an Excel cell and select 'Paste Link' and the current parameter value will be displayed in the cell.
Copy/Paste Item	Copy & Paste
Add Item	Add a new variable by name (easier to browse the navigation tree)
Remove Item	Remove the selected item.
Write Value	Write a new value (not if the item is Read Only).
Item appears on Chart	Up to 8 items can be trended on the Chart Window
Item Properties	Gives the item properties as seen by OPC

The OPC List can contain parameters from any instrument attached to the Modbus network.

If you have iTools Open (not iTools Standard) then OPC Scope can run on a remote networked computer. Enter the name of the server computer (attached to the instruments) the 'Computer' window and browse for the 'Eurotherm.ModbusServer1'.

2.9.2 OPC Scope Chart Window

Click the Chart tab  at the bottom of the display window and select Chart Control Panel.

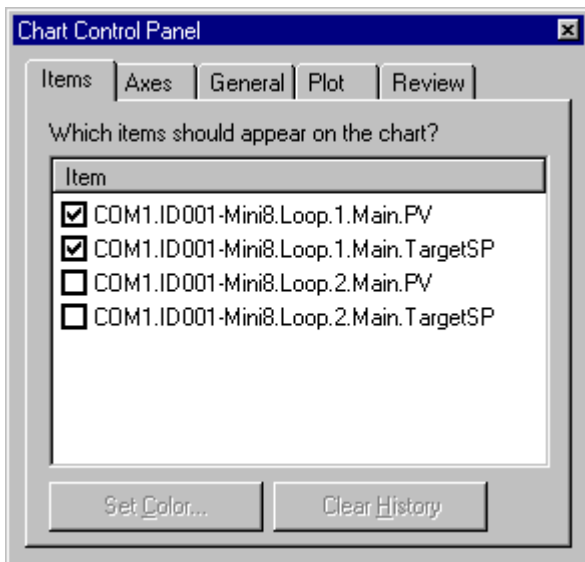

1. **Items.** Includes all the items in the list window. Those items ticked (up to 8) will appear on the chart.
2. **Axes.** Allows time intervals from 1 minute to 1 month. Vertical axes can be 'auto' scaled or a fixed range may be entered.
3. **General.** Allows selection of colours, grid, legends and a data box.
4. **Plot.** Allows selection of line thickness and printing
5. **Review.** Allows review of early history charts.

These are also available on the toolbar.

iTools Trend Graph showing Loop1 SP and PV

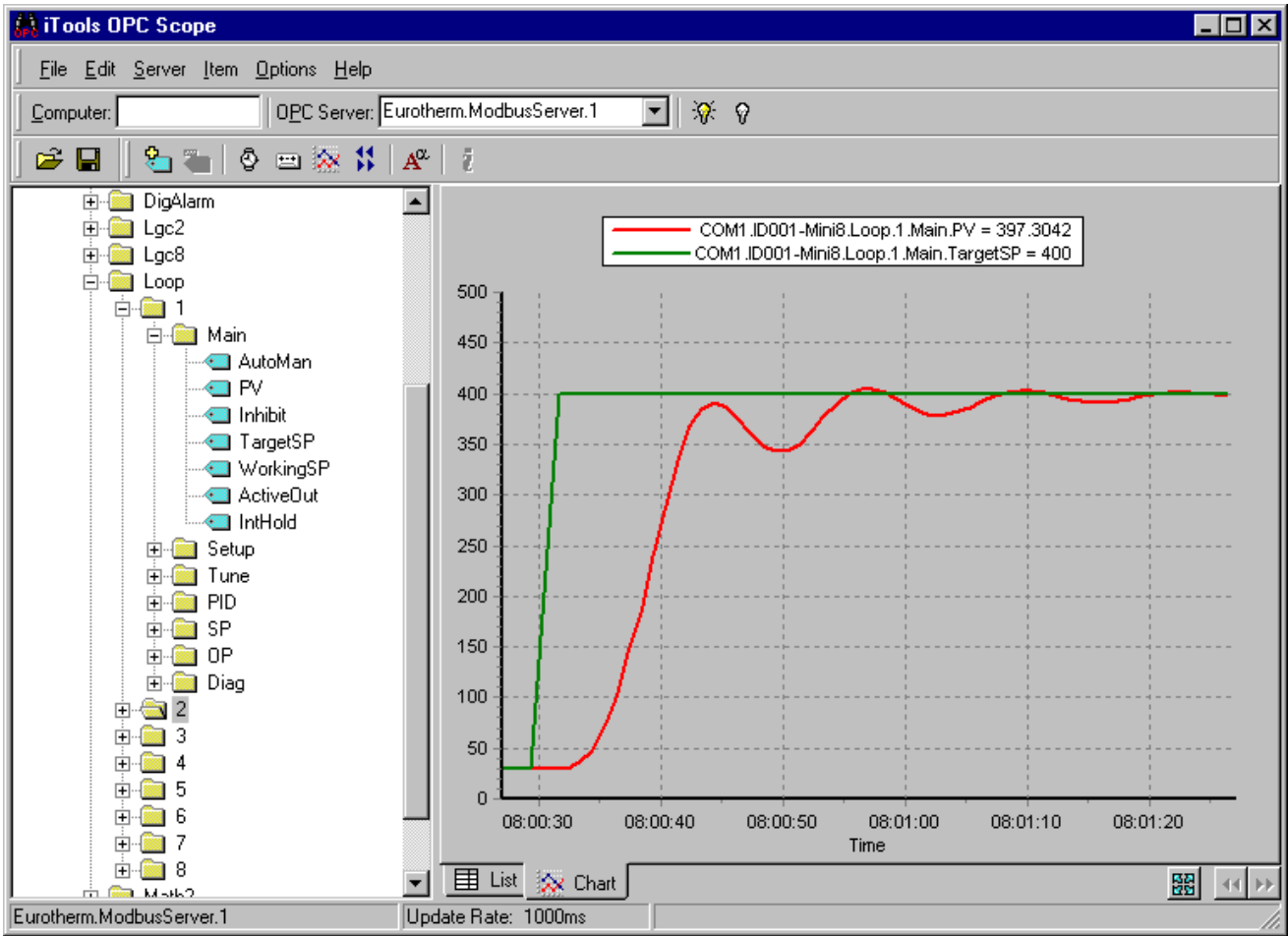

The  icon allows the chart to occupy all the window space.

2.9.3 OPC Server

iTools and OPC Scope all use the Eurotherm OPC Server to provide the connection between the instruments and the computer displays. When you 'scan' for instruments on iTools it is in fact the OPC Server that is actually doing the work in background (the window is not usually displayed).

OPC Scope can run on its own but for it to find the instruments on the network it is necessary to tell the server where they are.

1. Start OPC Server (Windows Start/Programs/Eurotherm iTools/OPC Server)
2. On the menu go to 'Network' and select 'Start One-Shot Scan'
3. Stop the scan when all the instruments have been found.

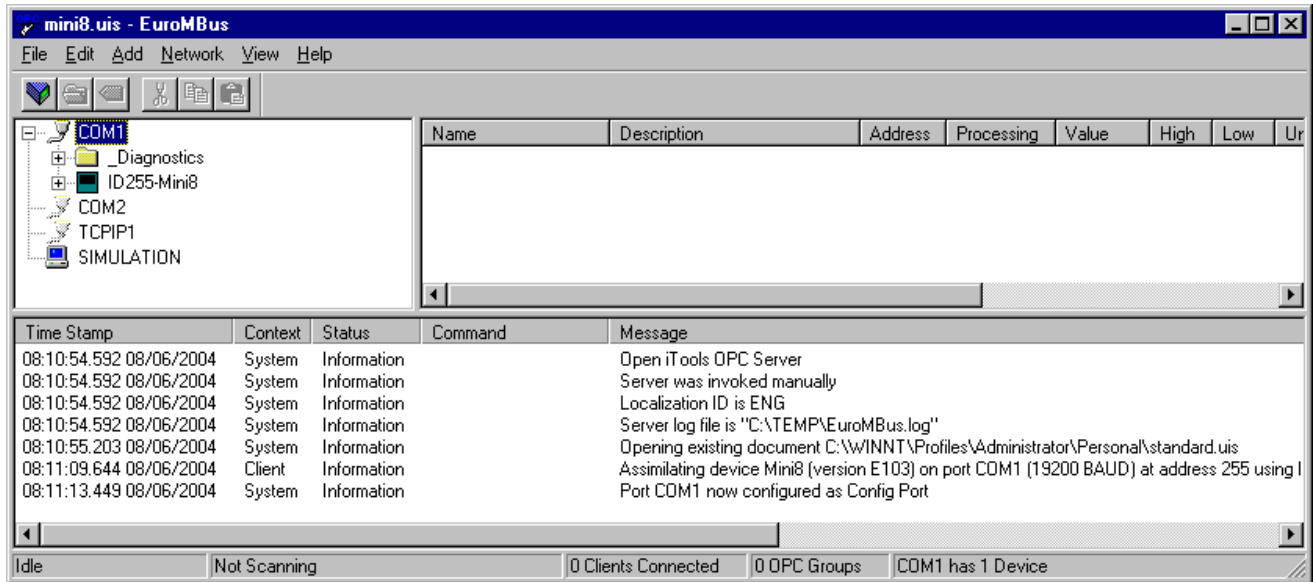

4. On the menu go to 'File' and select 'Save As' and save the file with a suitable name.
5. Once saved you will be asked 'Would you like to make this file the default start server address file?' - select 'Yes'.
6. Close the server.

Now if you double click on an OPC Scope file e.g. Mini8 Project.uix then this file will open OPC Scope and in turn, in background, OPC scope will open the OPC Server with this instrument file loaded. OPC Scope will then be active with live data from the instrument(s).

3. Chapter 3 Configuration Using ITools

WARNING

Configuration level gives access to a wide range of parameters that match the controller to the process. Incorrect configuration could result in damage to the process being controlled and/or personal injury. It is the responsibility of the person commissioning the process to ensure that the configuration is correct.

In configuration level the controller may not be controlling the process or providing alarm indication. Do not select configuration level on a live process.

3.1 Configuration

The Mini8 controller is supplied unconfigured, unless ordered preconfigured, e.g. EC8. An unconfigured Mini8 controller has to be configured for use in an application. This is performed using iTools.

The iTools handbook, part no. HA028838 provides further step by step instructions on the general operation of iTools. This and the iTools software may be downloaded from www.eurotherm.co.uk.

3.1.1 On-Line/Off-line Configuration

If iTools is connected to a real Mini8 controller then all the parameter changes made will be written to the device immediately. Once the Mini8 controller is configured and working as required, its final configuration can be saved to disk as a 'clone' file of the format <name>.uic.

Alternatively iTools can be used 'off-line' without a real Mini8 controller connected at all. This virtual Mini8 controller can be created in iTools and again saved to disk as a clone file. This file can later be loaded into a real Mini8 controller to create the required real application. See Section 3.3.

3.2 Connecting a PC to the Mini8 Controller

3.2.1 Configuration Cable and Clip

The controller may be connected to the PC running iTools using the Eurotherm cable **SubMin8/Cable/Config** from the RJ11 port connecting to a serial port on the PC.

Alternatively a Configuration Clip is available from Eurotherm that can be fitted into the rear of the controller.

The benefit of using this arrangement is that it is not necessary to power the controller, since the clip provides the power to the internal memory of the controller.

3.2.2 Scanning

Open iTools and, with the controller connected, press  on the iTools menu bar. iTools will search the communications ports and TCP/IP connections for recognisable instruments. Controllers connected using the RJ11 configuration port or with the configuration clip (CPI), will be found at address 255 regardless of the address configured in the controller. These connections only work from iTools to a single controller.

The iTools handbook, part no. HA028838, provides further step by step instructions on the general operation of iTools. This and the iTools software may be downloaded from www.eurotherm.co.uk.

In the following pages it is assumed that the user is familiar with iTools and has a general understanding of Windows.

3.3 Cloning

Saving a Clone File

On the iTools menu 'File - Save to File' allows the clone file of the attached Mini8 controller to be saved to disc as <user name>.UIC file. This can be loaded into another Mini8 controller.

Note that after synchronization iTools using uses a 'quick' save and will only resave parameters that have been changed through iTools itself. If there is any chance that parameters have been changed through the other port then it is necessary to resave all the parameters. On the menu bar under Options - Cloning ensure **Reload** is selected. The safest option is to keep **Ask** selected.

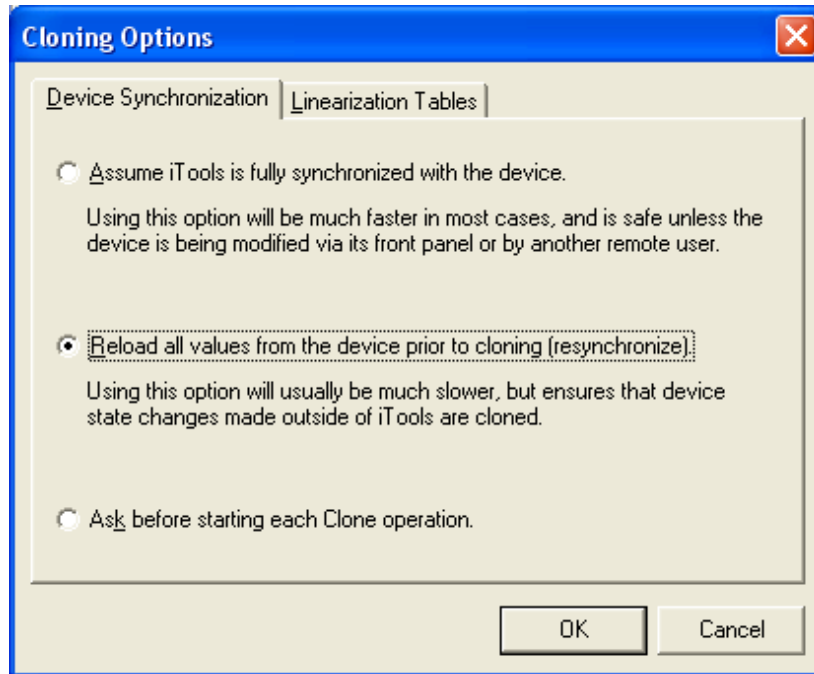

Loading a clone file

On the iTools menu 'File - Load values File' allows a clone file of the form <user name>.UIC to be loaded into an attached Mini8 controller unit. Whilst loading, the report window will indicate what is happening. It makes a number of attempts to load all the values and may report some errors. This is generally not an issue. If for some reason the load fails iTools will report specifically that the load **Failed**

Communications port parameters

A Mini8 controller clone file contains information on both the CC and FC port config settings. Depending on which comms port is used to load a clone file cloning will behave in a different manner.

Loading the clone file through the FC port will cause the CC port settings to be updated

Loading the clone file through the CC port will cause the FC port settings to be updated

3.4 Configuring the Mini8 Controller

Once iTools is successfully connected to a Mini8 controller, it can be configured for the application in hand. Configuration involves selection of the required elements of functionality called 'function blocks' and setting their parameters to the correct values. The next stage is to connect all the function blocks together to create the required strategy of control for the application.

3.4.1 Function Blocks

The controller software is constructed from a number of 'function blocks'. A function block is a software device that performs a particular duty within the controller. It may be represented as a 'box' that takes data in at one side (as inputs), manipulates the data internally (using internal parameter values) and 'outputs' the results. Some of these internal parameters are available to the user so that they can be adjusted to suit the characteristics of the process that is to be controlled.

A representation of a function block is shown below.

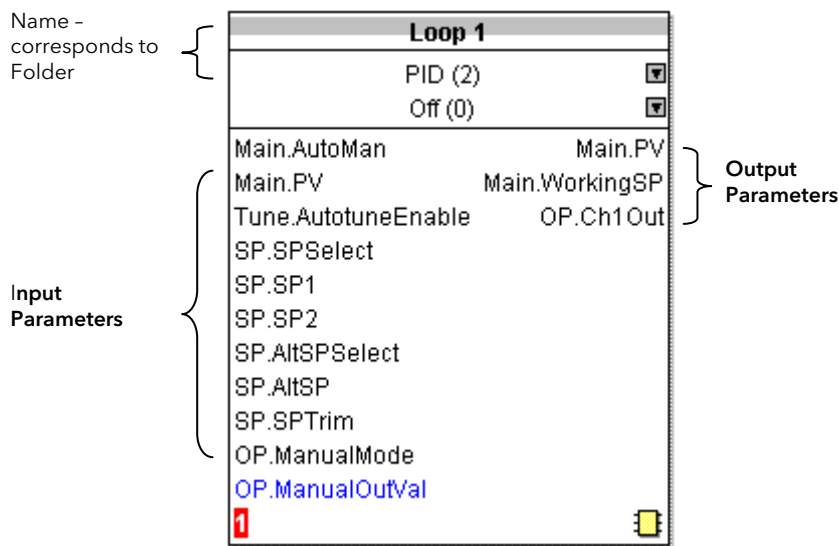

Internal Parameters

Function Block: Loop 1			
Main Setup Tune PID SP OP Diag			
Name	Description	Value	
SchedulerType	Scheduler Type	Off (0)	
ProportionalBand	Proportional Band	309.36	
IntegralTime	Integral Time	11.96	
DerivativeTime	Derivative Time	1.99	
RelCh2Gain	Relative Cool/Ch2 Gain	1.00	
CutbackHigh	Cutback High	Auto (0)	
CutbackLow	Cutback Low	Auto (0)	
ManualReset	Manual Reset	0.00	
LoopBreakTime	Loop Break Time	23.92	
OutputHi	Gain Scheduled Output Hi Li	100.00	
OutputLo	Gain Scheduled Output Lo L	-100.00	

Figure 3-1: Example of a Function Block

In the controller, parameters are organised in simple lists. The top of the list shows the list header. This corresponds to the name of the function block and is generally presented in alphabetical order. This name describes the generic function of the parameters within the list. For example, the list header 'AnAlm' contains parameters that enable you to set up analogue alarm conditions.

3.4.2 Soft Wiring

Soft Wiring (sometimes known as User Wiring) refers to the connections that are made in software between function blocks. Soft wiring, which will generally be referred to as 'Wiring' from now on is created during the instrument configuration using the iTools configuration package.

In general every function block has at least one input and one output. Input parameters are used to specify where a function block reads its incoming data (the 'Input Source'). The input source is usually wired from the output of a preceding function block. Output parameters are usually wired to the input source of subsequent function blocks.

All parameters shown in the function block diagrams are also shown in the parameter tables, in the relevant chapters, in the order in which they appear in iTools.

Figure 3.2 shows an example of how the thermocouple is wired to the PID Loop input and the PID Loop channel 1 (heat) output is wired to the time proportioning logic output.

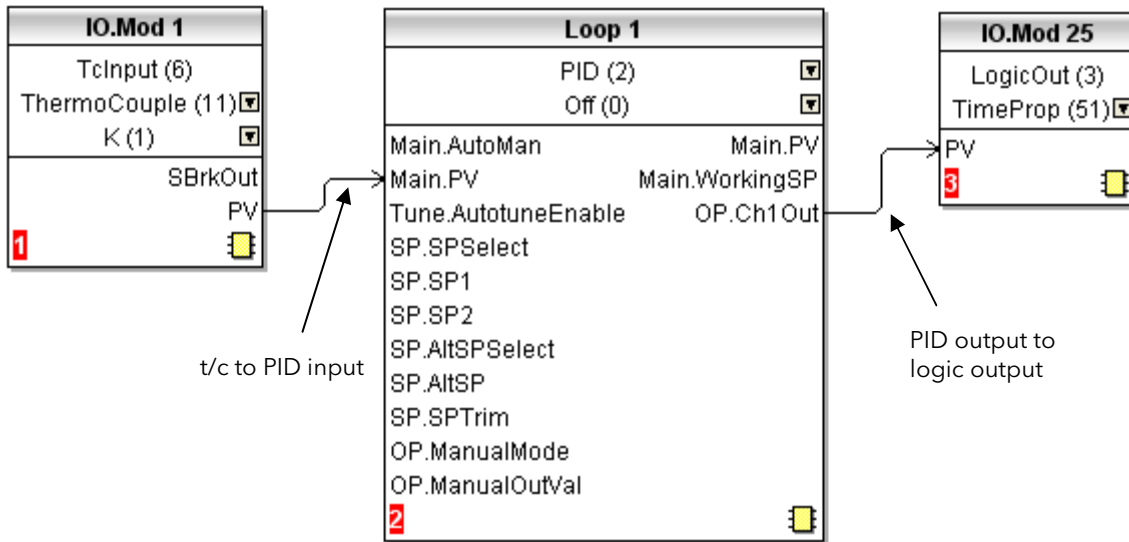

Figure 3-2: Function Block Wiring

3.5 Simple Worked Example

Using function blocks and wiring the following sections will show a blank Mini8 controller being configured to have one PID loop.

3.5.1 The I/O

With the Mini8 controller successfully connected to iTools configuration can begin.

☺ Tip: In parameter lists:
 Parameters in BLUE are read only
 Parameters in BLACK are read/write.

☺ Tip: Every parameter in the parameter lists has a detailed description in the help file – just click on a parameter and hit Shift-F1 on the keyboard or right click and select parameter help.

The I/O will already have been installed in the Mini8 controller and can be checked in iTools.

Example 1: Thermocouple Input Configuration

In the IO list ModIDs select the type of module. Thermocouple modules may be 4 input modules or 8 input modules.

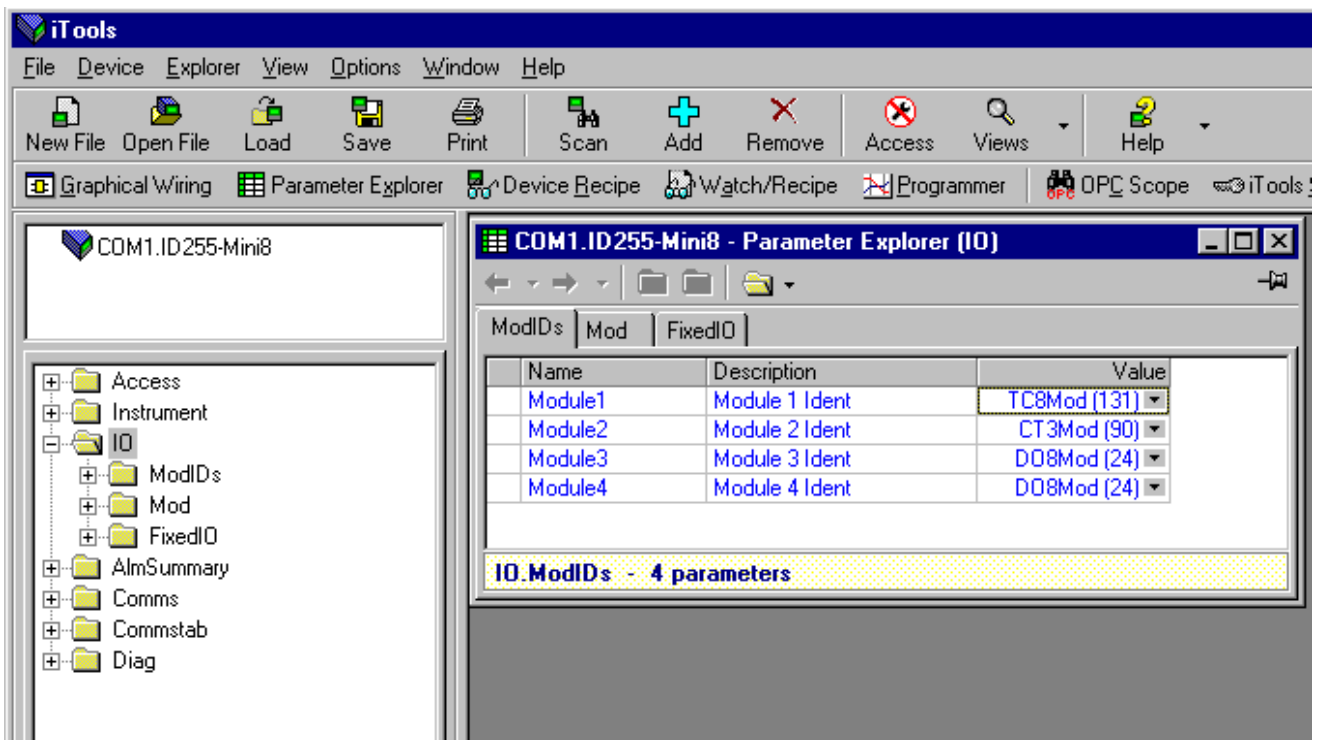

Figure 3-3: Mini8 controller I/O Modules

This unit has an 8 thermocouple input board in slot 1, a CT3 input card in slot 2, and 2 DO8 output cards in slot 3 and slot 4. Clicking on the 'Mod' tab will enable the first channel of the thermocouple card to be configured. Firstly the Mini8 controller has to be put into configuration mode. Go to Device/Access/Configuration or click on the Access button:



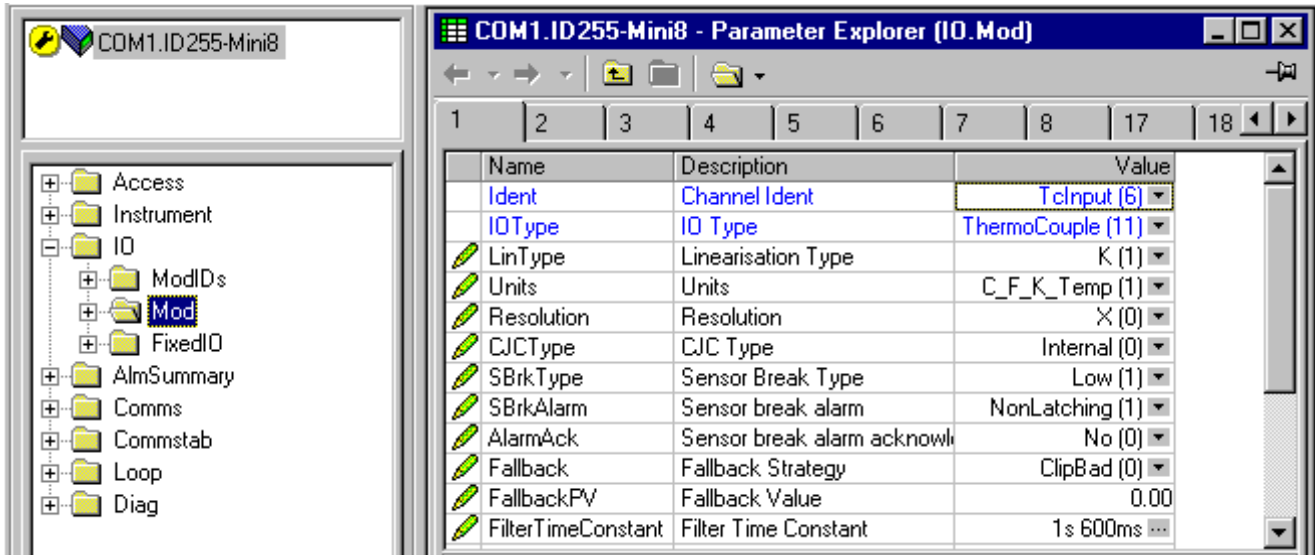

Figure 3-4: Thermocouple Input

Select the I/O type, linearisation, units, resolution etc. required. Parameter details are in Section 7.5.

The other thermocouple channels can be found by using the 2, 3, 4...7, 8 tabs on the top of the parameter window. Slot 2 in the Mini8 controller has a CT3 input card and this is configured elsewhere so the Tabs 9 to 16 are not shown. Slot 3 has a DO8 output card and the first channel of this will be on tab 17 (to 24) Slot 4 has a DO8 output card and the first channel of this will be on tab 25 (to 32)

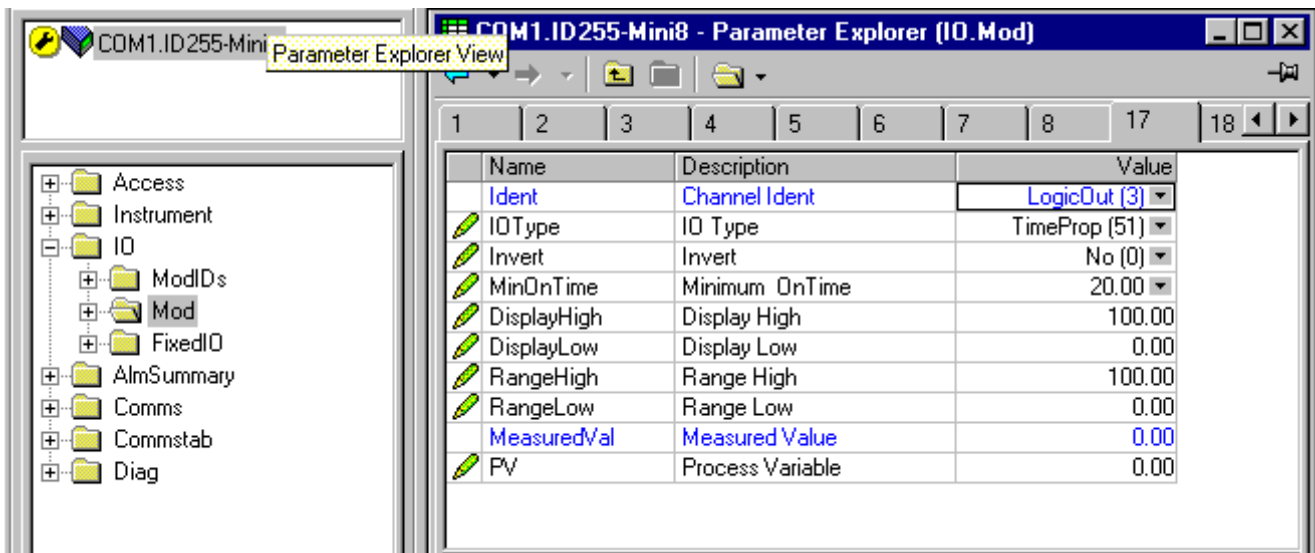

Figure 3-5: Digital Output Channel

Set this channel up as required, IOType, MinOnTime etc. as required. The parameters are detailed in Section 7.3. The remaining channels on this slot will be found under the tabs 18 to 24. Slot 4 also contains a DO8 output card with outputs under tabs 25 to 32. The fixed I/O is always there and there is nothing that has to be configured. The Current Monitor is covered in Chapter 7.9.

Example 2: RTD Input Configuration

In the IO list ModIDs select the type of module. RTD modules are 4 input modules [RT4Mod (173)].

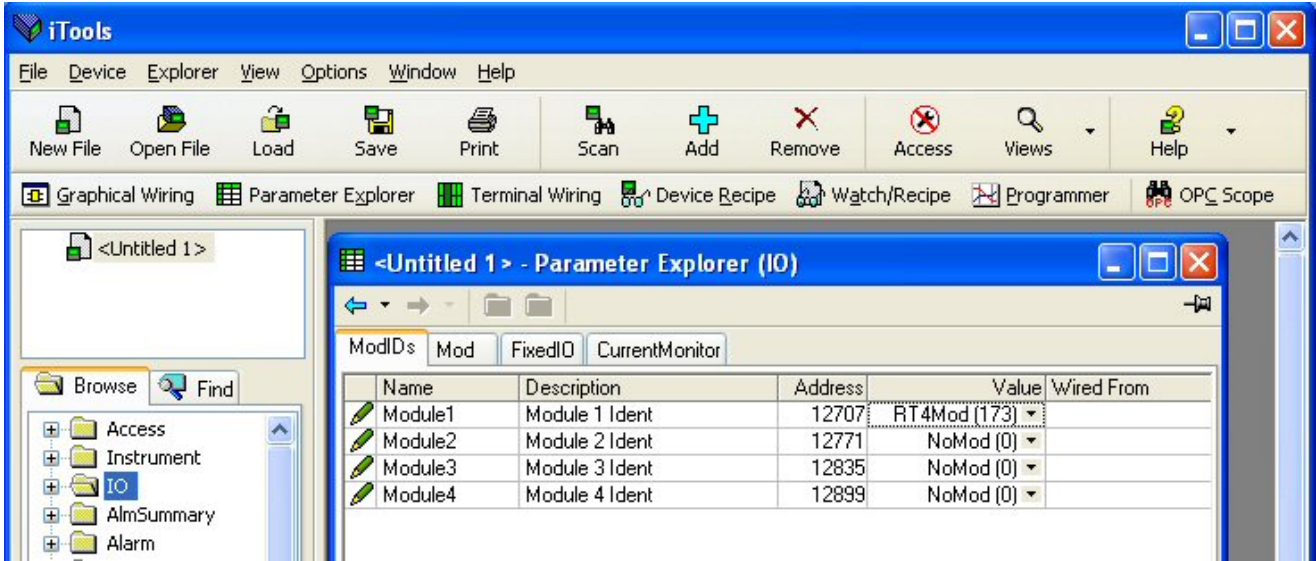

Figure 3-6: Mini8 Controller IO Module1 Defined as RTD

RTDs can be defined as 2-wire [RTD2 (32)], 3-wire [RTD3 (33)] or 4-wire [RTD4 (34)] in the module definition list. It is important that the 'IO Type' is configured to match the RTD in use so that the correct lead compensation calculation is selected.

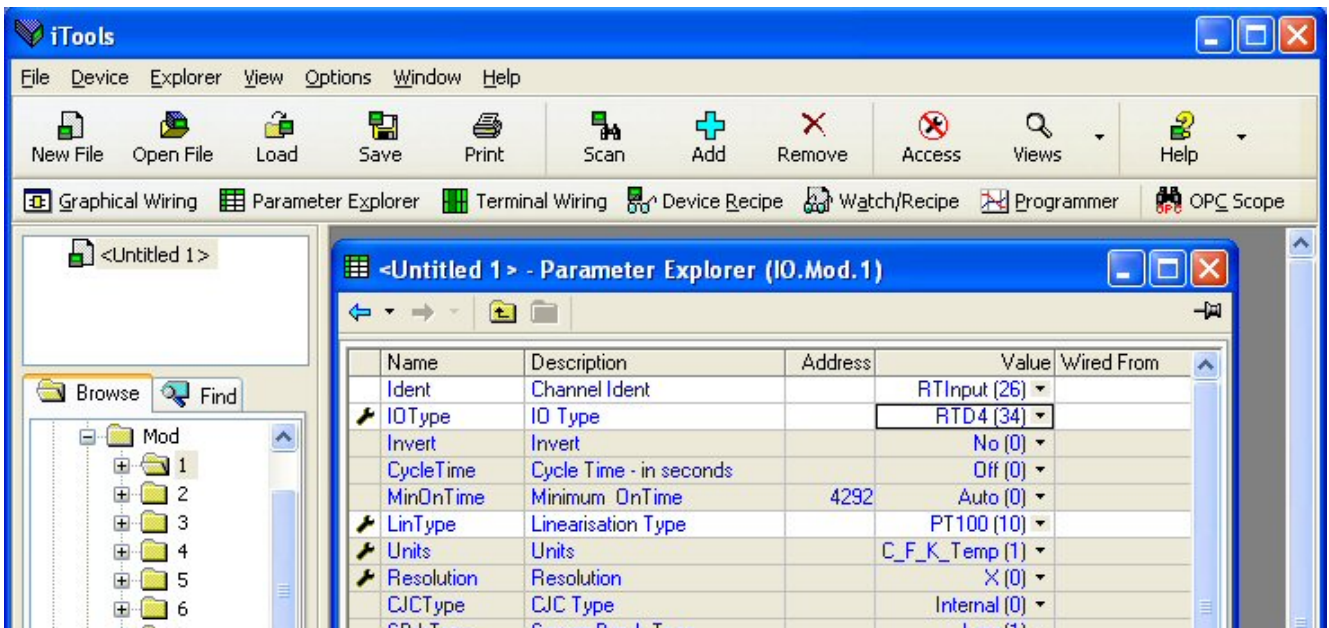



Figure 3-7: Module 1 defined as RTD4

3.5.2 Wiring

The IO that has been configured now needs to be wired to PID loops and other function blocks.

Select  Graphical Wiring (GWE) to create and edit instrument wiring.

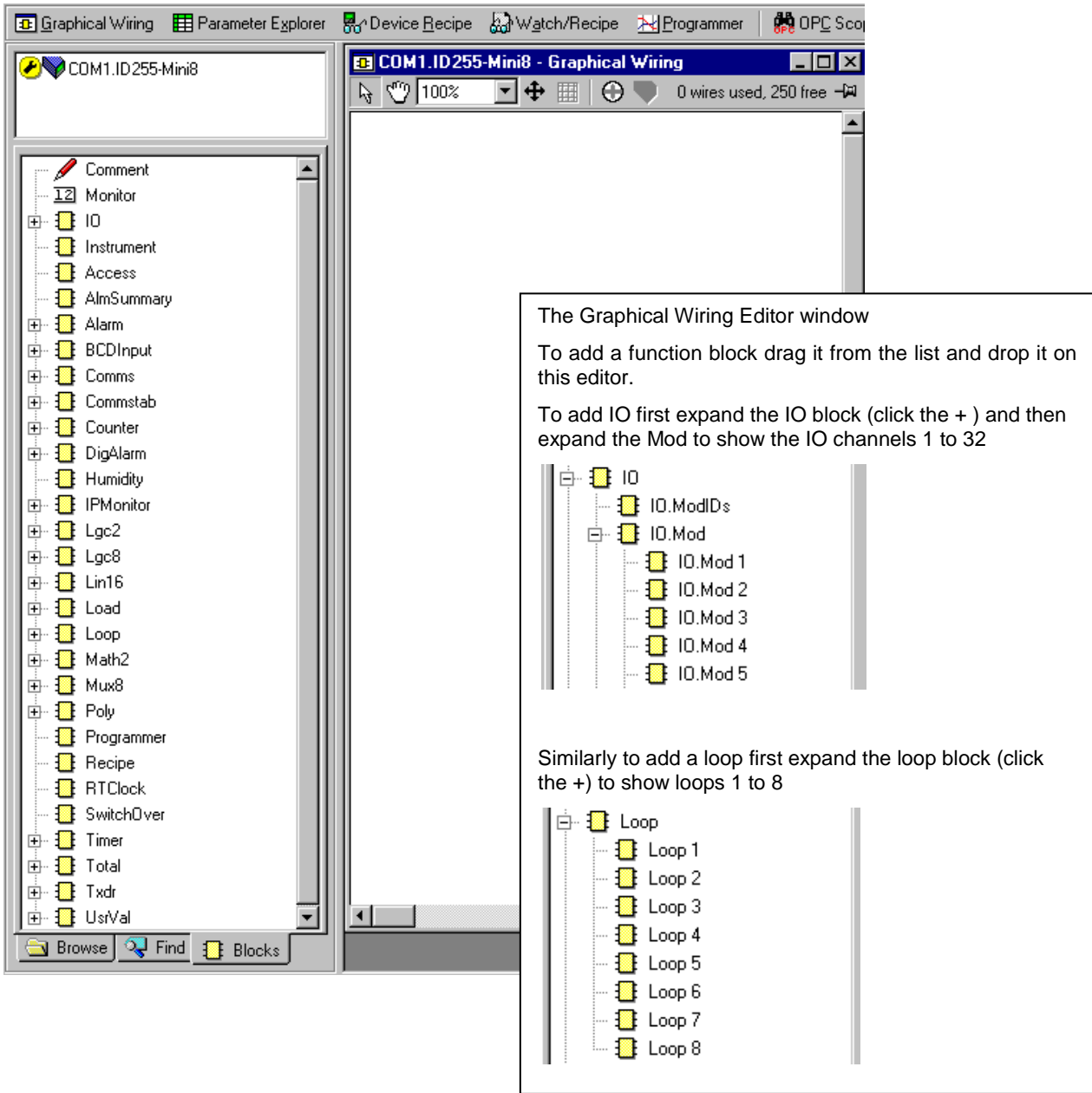

Figure 3-8: List of Function Blocks & Graphical Wiring Window

The left window now contains a list of the function blocks available.

Use drag and drop to select the first thermocouple from IOMod 1, the Cool output from IOMod 17 and the Heat output from IOMod 25 and drop them on the wiring window.

Finally take the first PID block from Loop/Loop 1 and drop it on the wiring window. Note that as each block is used it greys out on the list.

There should now be 4 blocks on the window. Those blocks are shown with dotted lines, as they have not been loaded into the Mini8 controller.

First make the following wire connections.

1. Click on IO.Mod1.PV and move the pointer to Loop 1.MainPV and click again. A dotted wire will have connected the two together.
2. Similarly join Loop1.OP.Ch1Out to IOMod 25.PV (heat output)
3. Enable the Cool output by clicking the select arrow to the top of the loop block:

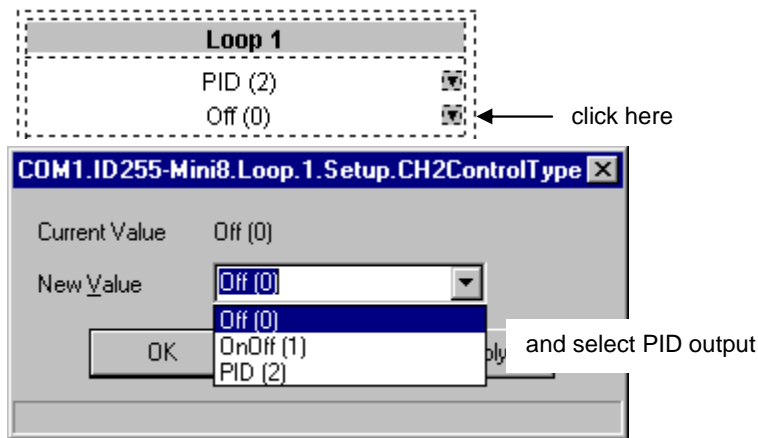

4. Loop1.OP.Ch2Out to IOMod 17.PV (cool output)

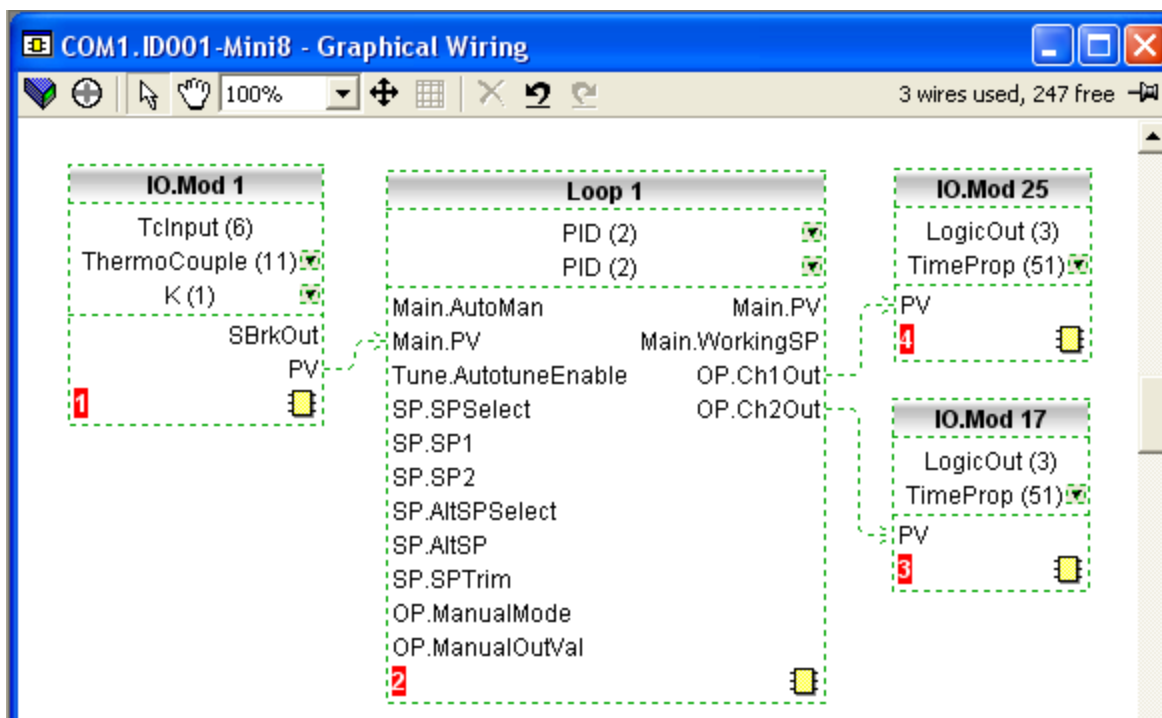

Figure 3-9: Wired Blocks before download

- Right click on the Loop 1 function Block and select 'Function Block View'. This opens the Loop parameter list on top of the wiring editor.

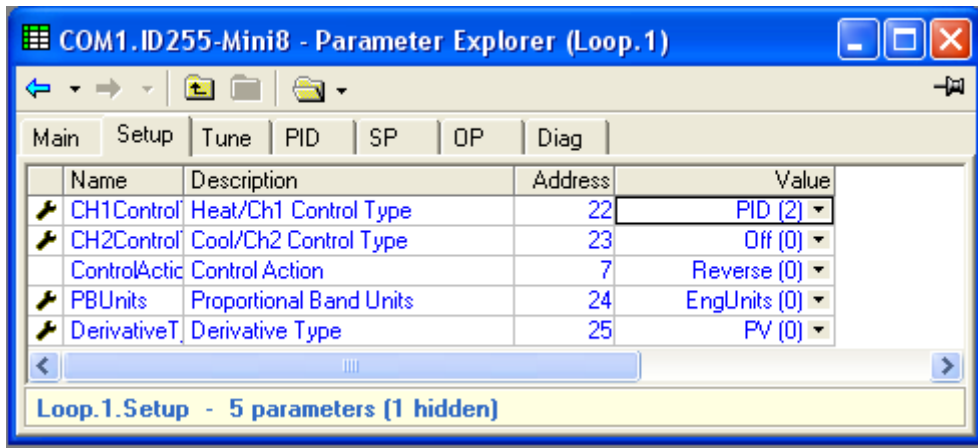

Figure 3-10: PID Function Block

This enables the PID function block to be set up to suit the required application. See Chapter 17 for details.

- Click on the instrument button to download the application:



- Once downloaded the dotted lines around the function blocks and the wires will become solid to show that the application is now in the Mini8 controller. The upper status line also shows that 3 wires have been used out of those available. Max is 250 but quantity depends on number of wires ordered (30, 60, 120 or 250).
- Put the Mini8 controller back into Operating mode by clicking the Access button:



- The Mini8 controller will now control the Loop1 as configured.

3.6 Graphical Wiring Editor

Select  **Graphical Wiring** (GWE) to view and edit instrument wiring. You can also add comments and monitor parameter values.

1. Drag and drop required function blocks into the graphical wiring from the list in the left pane
2. Click on parameter to be wired from and drag the wire to the parameter to be wired to (do not hold mouse button down)
3. Right click to edit parameter values
4. Select parameter lists and switch between parameter and wiring editors
5. Download to instrument when wiring completed
6. Add comments and notes
7. Dotted lines around a function block show that the application requires downloading

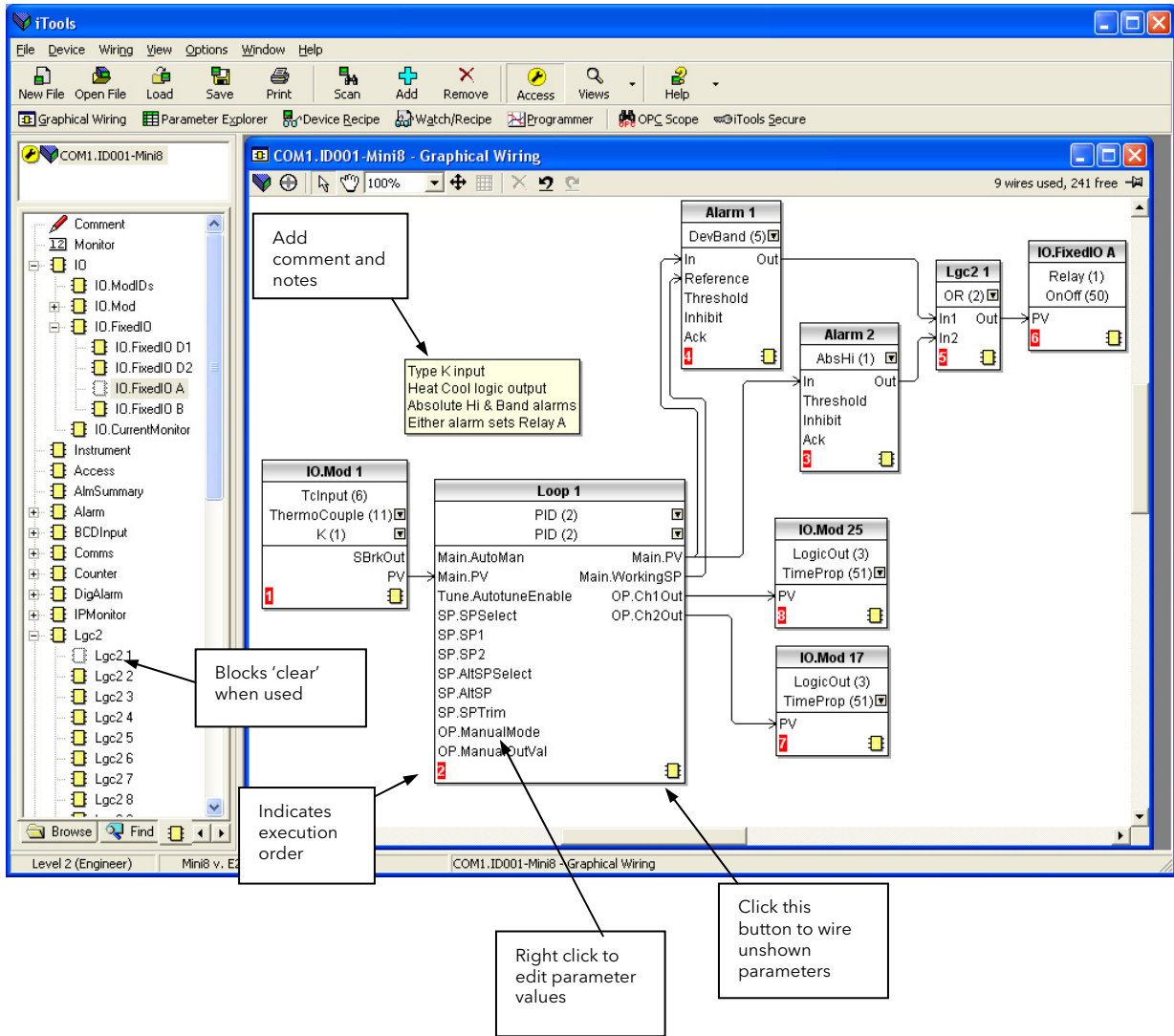

3.6.1 Graphical Wiring Toolbar

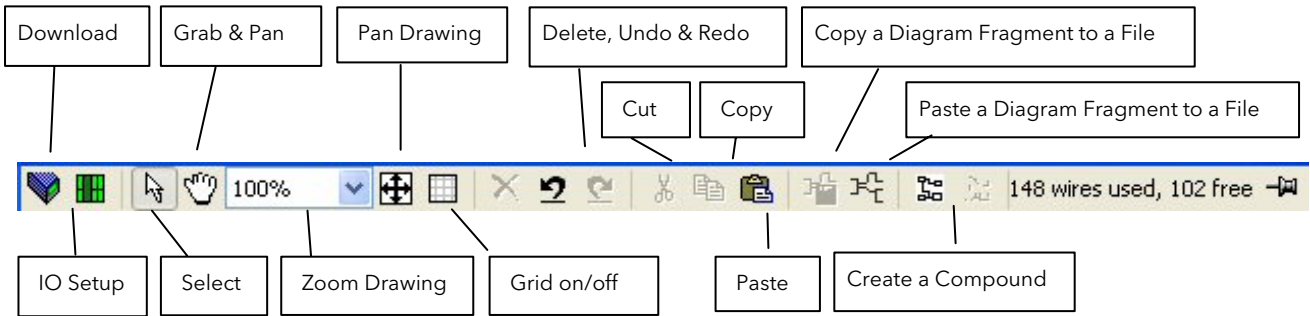

3.6.2 Function Block

A Function Block is an algorithm that may be wired to and from other function blocks to make a control strategy. The Graphical Wiring Editor groups the instrument parameters into function blocks. Examples are: a control loop and a mathematical calculation.

Each function block has inputs and outputs. Any parameter may be wired from, but only parameters that are alterable may we wired to.

A function block includes any parameters that are needed to configure or operate the algorithm.

3.6.3 Wire

A wire transfers a value from one parameter to another. They are executed by the instrument once per control cycle.

Wires are made from an output of a function block to an input of a function block. It is possible to create a wiring loop, in this case there will be a single execution cycle delay at some point in the loop. This point is shown on the diagram by a || symbol and it is possible to choose where that delay will occur.

3.6.4 Block Execution Order

The order in which the blocks are executed by the instrument depends on the way in which they are wired.

The order is automatically worked out so that the blocks execute on the most recent data.

3.6.5 Using Function Blocks

If a function block is not faded in the tree then it can be dragged onto the diagram. The block can be dragged around the diagram using the mouse.

A labelled loop block is shown here. The label at the top is the name of the block.

When the block type information is alterable, click on the box with the arrow in it on the right to edit that value.

The inputs and outputs that are considered to be of most use are always shown. In most cases all of these will need to be wired up for the block to perform a useful task. There are exceptions to this and the loop is one of those exceptions.

If you wish to wire from a parameter, which is not shown as a recommended output click on the icon in the bottom right, and a full list of parameters in the block will be shown, click on one of these to start a wire.

To start a wire from a recommended output just click on it.

Click the icon in the bottom right hand corner to wire other function block parameters not shown on the list on the right hand side.

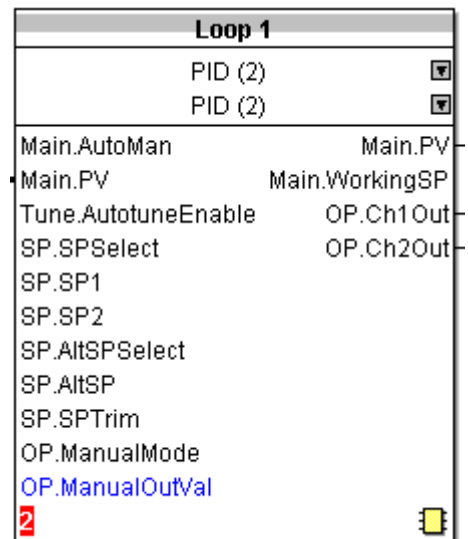

3.6.5.1 Function Block Context Menu

Right clicking displays the context menu with the following entries.

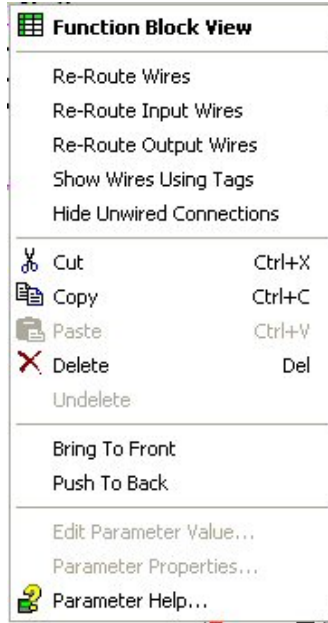

Function Block View	Brings up an iTools parameter list which shows all the parameters in the function block. If the block has sub-lists these are shown in tabs
Re-Route Wires	Throw away current wire route and do an auto-route of all wires connected to this block
Re-Route Input Wires	Only do a re-route on the input wires
Re-Route Output Wires	Only do a re-route on the output wires
Show wires using tags	Shows the beginning and end of each wire with a descriptor showing the source or destination. Used to simplify a diagram with many wires.
Hide Unwired Connections	Hides function block pins that are not used.
Cut	Cut the selected function block
Copy	Right click over an input or output and copy will be enabled, this menu item will copy the iTools "url" of the parameter which can then be pasted into a watch window or OPC Scope
Paste	Add a new copy of the function block
Delete	If the block is downloaded mark it for delete, otherwise delete it immediately
Undelete	This menu entry is enabled if the block is marked for delete and unmarks it and any wires connected to it for delete
Bring To Front	Bring the block to the front of the diagram. Moving a block will also bring it to the front
Push To Back	Push the block to the back of the diagram. Useful if there is something underneath it
Edit Parameter Value	This menu entry is enabled when the mouse is over an input or output parameter. When selected it creates a parameter edit dialog so the value of that parameter can be changed
Parameter Properties	Selecting this entry brings up the parameter properties window. The parameter properties window is updated as the mouse is moved over the parameters shown on the function block
Parameter Help	Selecting this entry brings up the help window. The help window is updated as the mouse is moved over the parameters shown on the function block. When the mouse is not over a parameter name the help for the block is shown

3.6.6 Tooltips

Hovering over different parts of the block will bring up tooltips describing the part of the block beneath the mouse. If you hover over the parameter values in the block type information a tooltip showing the parameter description, its OPC name, and, if downloaded, its value will be shown.

A similar tool-tip will be shown when hovering over inputs and outputs.

3.6.7 Function Block State

The blocks are enabled by dragging the block onto the diagram, wiring it up, and downloading it to the instrument

When the block is initially dropped onto the diagram it is drawn with dashed lines.

When in this state the parameter list for the block is enabled but the block itself is not executed by the instrument.

Once the download button is pressed the block is added to the instrument function block execution list and it is drawn with solid lines.

If a block which has been downloaded is deleted, it is shown on the diagram in a ghosted form until the download button is pressed.

This is because it and any wires to/from it are still being executed in the instrument. On download it will be removed from the instrument execution list and the diagram. A ghosted block can be undeleted using the context menu.

When a dashed block is deleted it is removed immediately.

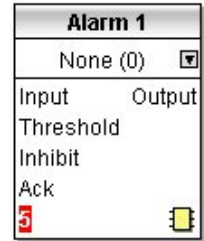
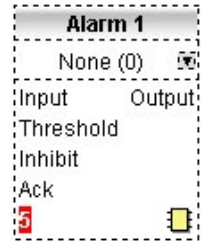

3.6.8 Using Wires

3.6.8.1 Making A Wire Between Two Blocks

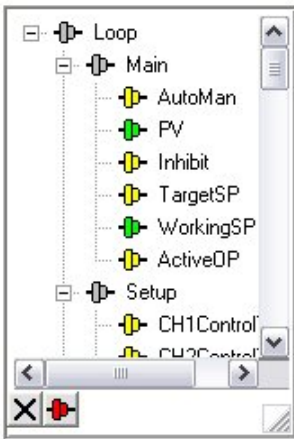

- Drag two blocks onto the diagram from the function block tree.
- Start a wire by either clicking on a recommended output or clicking on the icon at the bottom right corner of the block to bring up the connection dialog. The connection dialog shows all the connectable parameters for the block, if the block has sub-lists the parameters are shown in a tree. If you wish to wire a parameter which is not currently available click the red button at the bottom of the connection dialog. Recommended connections are shown with a green plug, other parameters which are available are yellow and if you click the red button the unavailable parameters are shown red. To dismiss the connection dialog either press the escape key on the keyboard or click the cross at the bottom left of the dialog.
- Once the wire has started the cursor will change and a dotted wire will be drawn from the output to the current mouse position.
- To make the wire either click on a recommended input to make a wire to that parameter or click anywhere except on a recommended input to bring up the connection dialog. Choose from the connection dialog as described above.
- The wire will now be auto-routed between the blocks.

New wires are shown dotted until they are downloaded

3.6.8.2 Wire Context Menu

The wire block context menu has the following entries on it.

Force Exec Break	If wires form a loop a break point has to be found where the value which is written to the block input comes from a block which was last executed during the previous instrument execute cycle thus introducing a delay. This option tells the instrument that if it needs to make a break it should be on this wire
Re-Route Wire	Throw away wire route and generate an automatic route from scratch
Use Tags	If a wire is between blocks which are a long way apart, then, rather than drawing the wire, the name of the wired to/from parameter can be shown in a tag next to the block. Draw the wire first then use this menu to toggle this wire between drawing the whole wire and drawing it as tags
Find Start	Find the source of the selected wire
Find End	Find the destination of the selected wire
Delete	If the wire is downloaded mark it for delete, otherwise delete it immediately
Undelete	This menu entry is enabled if the wire is marked for delete and unmarks it for delete
Bring To Front	Bring the wire to the front of the diagram. Moving a wire will also bring it to the front
Push To Back	Push the wire to the back of the diagram

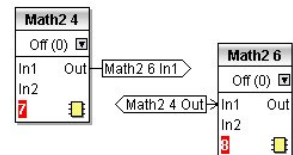

3.6.8.3 Wire Colours

Wires can be the following colours:

Black	Normal functioning wire.
Red	The wire is connected to an input which is not alterable when the instrument is in operator mode and so values which travel along that wire will be rejected by the receiving block
Blue	The mouse is hovering over the wire, or the block to which it is connected it selected. Useful for tracing densely packed wires
Purple	The mouse is hovering over a 'red' wire

3.6.8.4 Routing Wires

When a wire is placed it is auto-routed. The auto routing algorithm searches for a clear path between the two blocks. A wire can be auto-routed again using the context menus or by double clicking the wire.

If you click on a wire segment you can drag it to manually route it. Once you have done this it is marked as a manually routed wire and will retain it's current shape. If you move the block to which it is connected the end of the wire will be moved but as much of the path as possible of the wire will be preserved.

If you select a wire by clicking on it, it will be drawn with small boxes on it's corners.

3.6.8.5 Tooltips

Hover the mouse over a wire and a tooltip showing the names of the parameters which are wired and, if downloaded, their current values will also be shown.

3.6.9 Using Comments

Drag a comment onto the diagram and the comment edit dialog will appear.

Type in a comment. Use new lines to control the width of the comment, it is shown on the diagram as typed into the dialog. Click OK and the comment text will appear on the diagram. There are no restrictions on the size of a comment. Comments are saved to the instrument along with the diagram layout information. Comments can be linked to function blocks and wires. Hover the mouse over the bottom right of the comment and a chain icon will appear, click on that icon and then on a block or a wire. A dotted wire will be drawn to the top of the block or the selected wire segment.

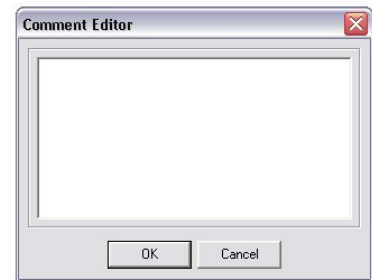

3.6.9.1 Comment Context Menu

The comment context menu has the following entries on it.

Edit	Open the comment edit dialog to edit this comment
Unlink	If the comment is linked to a block or wire this will unlink it
Cut	Remove the comment
Copy	To make a copy of the comment
Paste	To Paste a new copy of the comment
Delete	If the comment is downloaded mark it for delete, otherwise delete it immediately
Undelete	This menu entry is enabled if the comment is marked for delete and unmarks it for delete
Bring To Front	Bring the comment to the front of the diagram. Moving a comment will also bring it to the front
Push To Back	Push the comment to the back of the diagram. Useful if there is something underneath it



3.6.10 Using Monitors

Drag a monitor onto the diagram and connect it to a block input or output or a wire as described in 'Using Comments'. The current value (updated at the iTools parameter list update rate) will be shown in the monitor. By default the name of the parameter is shown, double click or use the context menu to not show the parameter name.

3.6.10.1 Monitor Context Menu

The monitor context menu has the following entries on it.

Show Names	Show parameter names as well as values
Unlink	If the monitor is linked to a block or wire this will unlink it
Cut	Remove the monitor
Copy	Make a copy of the monitor
Paste	Paste the copy of the monitor
Delete	If the monitor is downloaded mark it for delete, otherwise delete it immediately
Undelete	This menu entry is enabled if the monitor is marked for delete and unmarks it for delete
Bring To Front	Bring the monitor to the front of the diagram. Moving a monitor will also bring it to the front
Push To Back	Push the monitor to the back of the diagram. Useful if there is something underneath it



3.6.11 Downloading

The wires have to be downloaded to the instrument together. When the wiring editor is opened the current wiring and diagram layout is read from the instrument. No changes are made to the instrument function block execution or wiring until the download button is pressed.

When a block is dropped on the diagram instrument parameters are changed to make the parameters for that block available. If you make changes and close the editor without saving them there will be a delay while the editor clears these parameters.

When you download, the wiring is written to the instrument that then calculates the block execution order and starts executing the blocks. The diagram layout including comments and monitors is then written into instrument flash memory along with the current editor settings. When you reopen the editor the diagram will be shown positioned the same as when you last downloaded.

3.6.12 Selections

Wires are shown with small blocks at their corners when selected. All other items have a dotted line drawn round them when they are selected.

3.6.12.1 Selecting Individual Items

Clicking on an item on the drawing will select it.

3.6.12.2 Multiple Selection

Control click an unselected item to add it to the selection, doing the same on a selected item unselects it.

Alternatively, hold the mouse down on the background and wipe it to create a rubber band, anything which isn't a wire inside the rubber band will be selected.

Selecting two function blocks also selects any wires which join them. This means that if you select more than one function block using the rubber band method any wires between them will also be selected.

Pressing Ctrl-A selects all blocks and wires.

3.6.13 Colours

Items on the diagram are coloured as follows:

- Red Function blocks, comments and monitors which partially obscure or are partially obscured by other items are drawn red. If a large function block like the loop is covering a small one like a math2 the loop will be drawn red to show that it is covering another function block. Wires are drawn red when they are connected to an input which is currently unalterable. Parameters in function blocks are coloured red if they are unalterable and the mouse pointer is over them
- Blue Function blocks, comments and monitors which are not coloured red are coloured blue when the mouse pointer is over them. Wires are coloured blue when a block to which the wire is connected is selected or the mouse pointer is over it. Parameters in function blocks are coloured blue if they are alterable and the mouse pointer is over them
- Purple A wire which is connected to an input which is currently unalterable and a block to which the wire is connected is selected or the mouse pointer is over it is coloured purple (red + blue)

3.6.14 Diagram Context Menu

Highlight an area of the graphical wiring by left clicking the mouse button and dragging around the required area. Right click in the area to show the Diagram Context Menu. The diagram context menu has the following entries:-

- Cut To delete the selected area
- Copy To make a copy of the selected area
- Paste To paste the selected area
- Re-Route Wires Throw away current wire route and do an auto-route of all selected wires. If no wires are selected this is done to all wires on the diagram
- Align Tops Line up the tops of all the selected items except wires
- Align Lefts Line up the left hand side of all the selected items except wires
- Space Evenly This will space the selected items such that their top left corners are evenly spaced. Select the first item, then select the rest by control-clicking them in the order you wish them to be spaced, then choose this menu entry
- Delete Marks all selected items for deletion (will be deleted on next download).
- Undelete This menu entry is enabled if any of the selected items are marked for deletion and unmarks them when selected
- Select All To select the complete graphical wiring
- Create Compound Create a new tab (Compound 1, 2, etc) of the selected area
- Rename To customise the Compound name.
- Copy Graphic If there is a selection it is copied to the clipboard as a Windows metafile, if there is no selection the whole diagram is copied to the clipboard as a Windows metafile. Paste into your favourite documentation tool to document your application. Some programs render metafiles better than others, the diagram may look messy on screen but it should print well
- Save Graphic Same as Copy Graphic but saves to a metafile rather than putting it on the clipboard
- Copy Fragment to File To make a copy of the selected area and save it to file
- Paste Fragment from File To paste the selected area from file
- Center To place the selected area in the centre of the graphical wiring view.

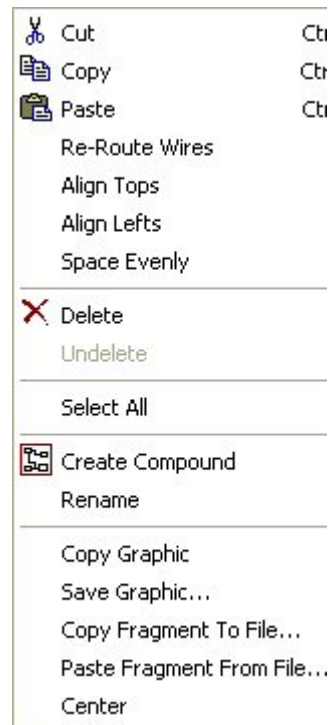

3.6.15 Wiring Floats with Status Information

There is a subset of float values which may be derived from an input which may become faulty for some reason, e.g. sensor break, over-range, etc. These values have been provided with an associated status which is automatically inherited through the wiring. The list of parameters which have associated status is as follows:-

Block	Input Parameters	Output Parameters
Loop.Main	PV	PV
Loop.SP		TrackPV
Math2	In1	Out
	In2	
Programmer.Setup	PVIn	
Poly	In	Out
Load		PVOut1
		PVOut2
Lin16	In	Out
Txdr	InVal	OutVal
IPMonitor	In	Out
SwitchOver	In1	
	In2	
Total	In	
Mux8	In1 to 8	Out
Multi-oper	In1 to 8	SumOut, MaxOut, MinOut, AverageOut
Lgc2	In1	
	In2	
UsrVal	Val	Val
Humidity	WetTemp	RelHumid
	DryTemp	DewPoint
	PsychroConst	
	Pressure	
IO.MOD	1.PV to 32.PV	1.PV to 32.PV

Parameters appear in both lists where they can be used as inputs or outputs depending on configuration. The action of the block on detection of a 'Bad' input is dependent upon the block. For example, the loop treats a 'Bad' input as a sensor break and takes appropriate action; the Mux8 simply passes on the status from the selected input to the output, etc.

The Poly, Lin16, SwitchOver, Multi-Operator, Mux8, IO.Mod.n.PV blocks can be configured to act on bad status in varying ways. The options available are as follows:-

0: Clip Bad

The measurement is clipped to the limit it has exceeded and its status is set to 'BAD', so that any function block using this measurement can operate its own fallback strategy. For example, a control output may be held at its current value.

1: Clip Good

The measurement is clipped to the limit it has exceeded and its status is set to 'GOOD', such that any function block using this measurement may continue to calculate and not employ its own fallback strategy.

2: Fallback Bad

The measurement will adopt the configured fallback value that has been set by the user. In addition the status of the measured value will be set to 'BAD', such that any function block using this measurement can operate its own fallback strategy. For example, control loop may hold its output to the current value.

3: Fallback Good

The measurement will adopt the configured fallback value that has been set by the user. In addition the status of the measured value will be set to 'GOOD', such that any function block using this measurement may continue to calculate and not employ its own fallback strategy

4: Up Scale

The measurement will be forced to adopt its high limit. This is like having a resistive pull up on an input circuit. In addition the status of the measured value will be set to 'BAD', such that any function block using this measurement can operate its own fallback strategy. For example, the control loop may hold its output to the current value.

5: Down Scale

The measurement will be forced to adopt its low limit. This is like having a resistive pull down on an input circuit. In addition the status of the measured value will be set to 'BAD', such that any function block using this measurement can operate its own fallback strategy. For example, the control loop may hold its output to the current value.

3.6.16 Edge Wires

If the Loop.Main.AutoMan parameter were wired from a logic input in the conventional manner it would be impossible to put the instrument into manual via communications. Other parameters need to be controlled by wiring but also need to be able to change under other circumstances, e.g. Alarm Acknowledgements. For this reason some Boolean parameters are wired in an alternative way.

These are listed as follows:-

SET DOMINANT

When the wired in value is 1 the parameter is always updated. This will have the effect of overriding any changes through digital communications. When the wired in value changes to 0 the parameter is initially changed to 0 but is not continuously updated. This permits the value to be changed through digital communications.

Loop.Main.AutoMan Programmer.Setup.ProgHold Access.StandBy

RISING EDGE

When the wired in value changes from 0 to 1, a 1 is written to the parameter. At all other times the wire does not update the parameter. This type of wiring is used for parameters that start an action and when once completed the block clears the parameter. When wired to, these parameters can still be operated via digital communications.

Loop.Tune.AutotuneEnable	Txdr.ClearCal	Alarm.Ack
	Txdr.StartCal	DigAlarm.Ack
Programmer.Setup.ProgRun	Txdr.StartHighCal	AlmSummary.GlobalAck
Programmer.Setup.AdvSeg	Txdr.StartTare	
Programmer.Setup.SkipSeg		Instrument.Diagnostics. ClearStats
IPMonitor.Reset		

BOTH EDGE

This type of edge is used for parameters which may need to be controlled by wiring or but should also be able to be controlled through digital communications. If the wired in value changes then the new value is written to the parameter by the wire. At all other times the parameter is free to be edited through digital communications.

Loop.SP.RateDisable Loop.OP.RateDisable

4. Chapter 4 Mini8 controller Overview

Input and output parameters of function blocks are wired together using software wiring to form a particular control strategy within the Mini8 controller. An overview of all the available functions and where to get more detail is shown below.

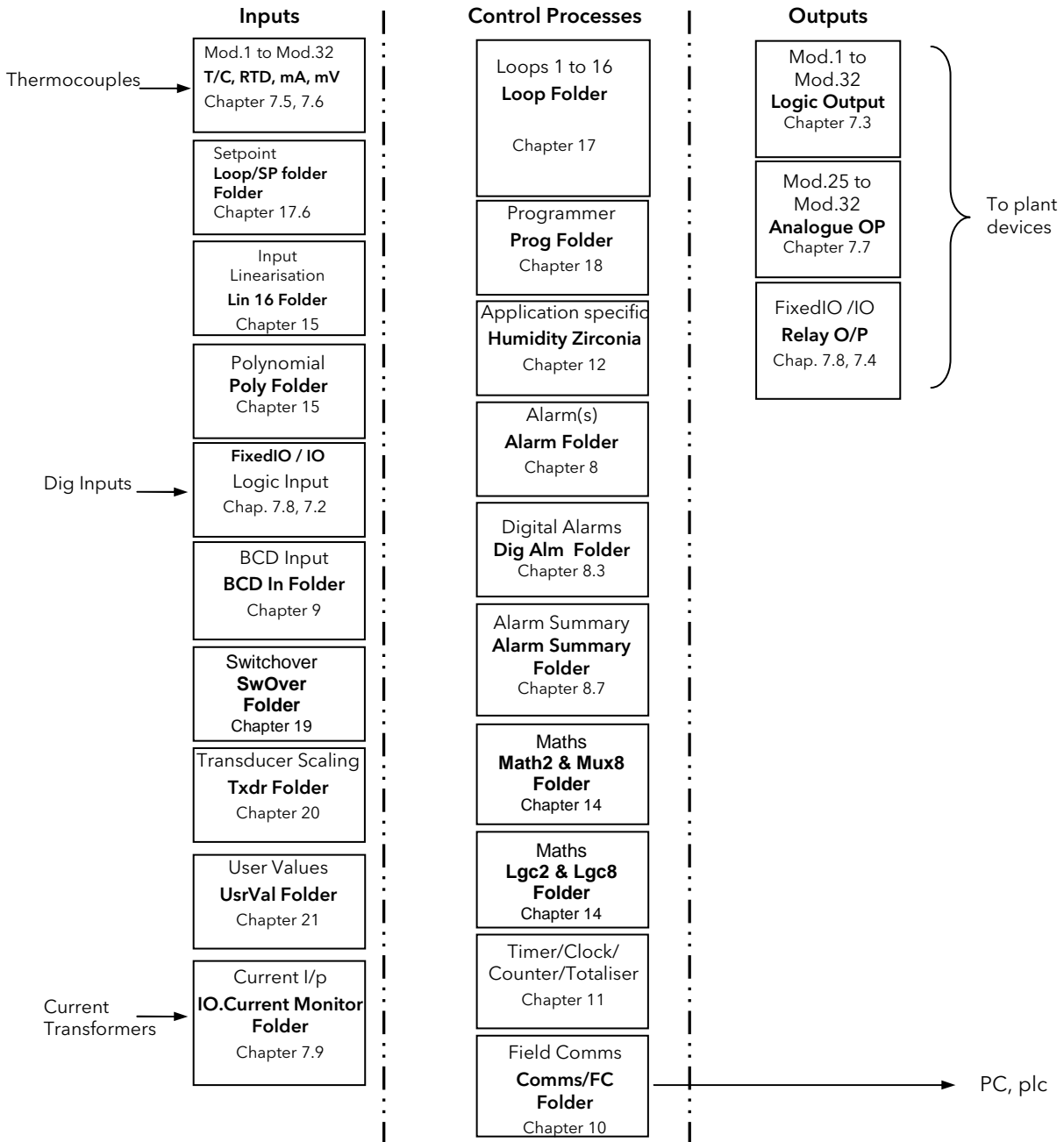

Figure 4-1: Controller Example

Mini8 controllers are supplied unconfigured, and with those blocks included in the order code. Option EC8 is supplied with function blocks pre-wired to give an 8 loop heat/cool controller suitable for Extrusion. See data sheet HA028519.

The purpose of the PID control blocks is to reduce the difference between SP and PV (the error signal) to zero by providing a compensating output to the plant via the output driver blocks.

The timer, programmer and alarms blocks may be made to operate on a number of parameters within the controller, and digital communications provides an interface to data collection and control.

The controller can be customised to suit a particular process by 'soft wiring' between function blocks.

4.1 Complete list of Function Blocks.

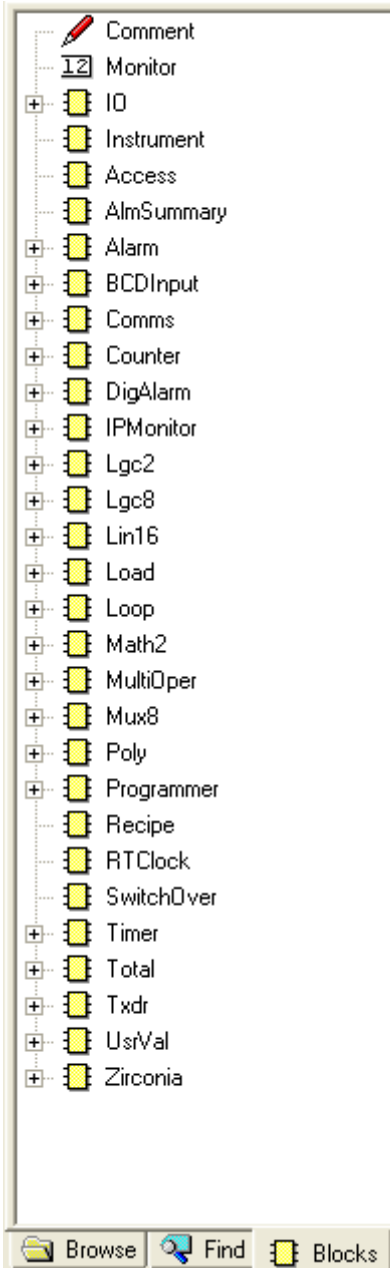

The list opposite represents an unconfigured Mini8 that has been ordered with all features enabled.

If a particular block or blocks do not appear in your instrument then the option has not been ordered. Check the order code of your instrument and contact Eurotherm.

Examples of features that may not have been enabled are:

Loops

Programmer

Recipe

Humidity

Once a block is dragged and dropped onto the graphical wiring window, the block icon in the block list opposite will be greyed out. At the same time a folder containing the blocks parameters will have been created in the Browse List.

5. Chapter 5 Access Folder

Folder: Access		Sub-folder: none			
Name	Parameter Description	Value		Default	Access Level
ClearMemory	Cold start the instrument	No	Disabled	No	Conf
		App	Mini8 controller memory reset but comms and linearisation tables retained		
		LinTables	Custom Linearisation tables are deleted		
		InitComms	Comms ports reset to default configurations		
		Wires	Clear all wiring		
		AllMemory	All instrument memory is set to default values		
		Programs	All Programs cleared		
CustomerID	Customer Identifier	Reference number for customer use		0	Oper
Standby	Set Instrument to standby	No / Yes		No	Oper

6. Chapter 6 Instrument Folder

6.1 Instrument / Enables

The following table lists the options that can be enabled in the instrument.

Enable flags are one bit for each item - i.e. Bit (0=1) enables item 1, Bit 1 (=2) item 2, Bit(3=4) item 3 and so on to Bit7(=128) enables Item 8. All 8 items enabled adds up to 255.

☺ Tip: **Features are not normally enabled this way.** Dragging and dropping a function block onto the graphical wiring window automatically sets the required enable flag.

Folder: Instrument		Sub-folder: Enables		
Name	Parameter Description	Value	Default	Access Level
AlarmEn1	Analogue alarms Enable Flags	Alarms 1 to 8 0 (none) to 255 (all 8)	0	Conf
AlarmEn2	Analogue alarms Enable Flags	Alarms 9 to 16 0 (none) to 255 (all 8)	0	Conf
AlarmEn3	Analogue alarms Enable Flags	Alarms 17 to 24 0 (none) to 255 (all 8)	0	Conf
AlarmEn4	Analogue alarms Enable Flags	Alarms 25 to 32 0 (none) to 255 (all 8)	0	Conf
BCDInEn	BCD switch input Enable Flags	BCD input 1 and 2 0 (none) to 3 (both)	0	Conf
CounterEn	Counters Enable Flags	Counters1 and 2 0 (none) to 3 (both)	0	Conf
CurrentMon (Only if CT3 module fitted)	Current Monitor Enable Flag	0 = Off 1 = On	0	Conf
DigAlmEn1	Digital alarms Enable Flags	Dig Alarms 1 to 8 0 (none) to 255 (all 8)	0	Conf
DigAlmEn2	Digital alarms Enable Flags	Dig Alarms 9 to 16 0 (none) to 255 (all 8)	0	Conf
DigAlmEn3	Digital alarms Enable Flags	Dig Alarms 17 to 24 0 (none) to 255 (all 8)	0	Conf
DigAlmEn4	Digital alarms Enable Flags	Dig Alarms 25 to 32 0 (none) to 255 (all 8)	0	Conf
HumidityEn	Humidity control Enable Flag	0 = off 1 = On	0	Conf
IP Mon En	Input monitor Enable Flags	Input Monitor 1 and 2 0 (none) to 3 (both)	0	Conf
Lgc2 En1	Logic operators Enable Flags	Logic operators 1 to 8 0 (none) to 255 (all 8)	0	Conf
Lgc2 En2	Logic operators Enable Flags	Logic operators 9 to 16 0 (none) to 255 (all 8)	0	Conf
Lgc2 En3	Logic operators Enable Flags	Logic operators 17 to 24 0 (none) to 255 (all 8)	0	Conf
Lgc8 En	Logic 8 operator Enable Flags	8 input Logic operators 1 & 2 0 (none) to 3 (both)	0	Conf
Lin16Pt En	Input linearisation 16 point	Input Linearisation 1 and 2 0 (none) to 3 (both)	0	Conf
Load En	Load Enable Flags	Loads 1 to 8 0 (none) to 255 (all 8)	As order code	Conf
Load En2	Load Enable Flags	Loads 9 to 16 0 (none) to 255 (all 8)	As order code	Conf
Loop En	Loop Enable Flags	Loops 1 to 8 0 (none) to 255 (all 8)	As order code	Conf
Loop En2	Loop Enable Flags	Loops 9 to 16 0 (none) to 255 (all 8)	As order code	Conf
Math2 En1	Analogue (Maths) Operators Enable Flags	Analogue operators 0 to 8 0 (none) to 255 (all 8)	0	Conf
Math2 En2	Analogue (Maths) Operators Enable Flags	Analogue operators 9 to 16 0 (none) to 255 (all 8)	0	Conf
Math2 En3	Analogue (Maths) Operators Enable Flags	Analogue operators 17 to 24 0 (none) to 255 (all 8)	0	Conf
MultiOperEn	Analogue Multi- Operator Enable Flags	Multi-operators 0 to 4 0 (none) to 15 (all 4)	0	Conf
Mux8 En	Multiplexor Enable Flags	8 input multiplexor 1 and 2 0 (none) to 3 (both)	0	Conf

Folder: Instrument		Sub-folder: Enables		
Name	Parameter Description	Value	Default	Access Level
Poly En	Polynomial linearisation block Enable Flags	Poly Linearisation 1 and 2 0 (none) to 3 (both)	0	Conf
Prog En	Programmer Enable Flags	0 = off, 1 to 8 0 (none) to 255 (all 8)	0	Conf
RTClock En	Real time clock Enable Flags	0 = off 1 = On	0	Conf
SwOver En	Switch over block Enable Flags	0 = off 1 = On	0	Conf
Timer En	Timers Enable Flags	Timers 1 to 4 0 = none to 15 = 4	0	Conf
Totalise En	Totalisers Enable Flags	Totalisers 1 & 2 0 (none) to 3 (both)	0	Conf
TrScale En	Transducer scaling Enable Flags	Transducer scalars 1 and 2 0 (none) to 3 (both)	0	Conf
UsrVal En1	User values Enable Flags	User Values 1 to 8 0 (none) to 255 (all 8)	0	Conf
UsrVal En2	User values Enable Flags	User Values 9 to 16 0 (none) to 255 (all 8)	0	Conf
UsrVal En3	User values Enable Flags	User Values 17 to 24 0 (none) to 255 (all 8)	0	Conf
UsrVal En4	User values Enable Flags	User Values 25 to 32 0 (none) to 255 (all 8)	0	Conf
Zirconia En	Zirconia Input Functions	0 = off 1 = On	0	Conf

6.2 Instrument Options

Folder: Instrument		Sub-folder: Options		
Name	Parameter Description	Value	Default	Access Level
Units	Units	°C, °F or Kelvin scale for all temperature parameters	DegC	Oper
ProgPVstart	To enable PV start	No, Yes - see section 18	No	Conf

6.3 Instrument / InstInfo

Folder: Instrument		Sub-folder: InstInfo		
Name	Parameter Description	Value	Default	Access Level
InstType	Instrument Type		MINI8	NONE
Version	Version Identifier		-	NONE
Serial No	Serial Number			NONE
Passcode1	Passcode1	0 to 65535		Oper
Passcode2	Passcode2	0 to 65535		Oper
Passcode3	Passcode3	0 to 65535		Oper
CompanyID	CompanyID		1280	NONE

6.4 Instrument / Diagnostics

This list provides fault finding diagnostic information as follows:-

Folder: Instrument	Sub-folder: Diagnostics	
Name	Parameter Description	
CPUFree	This is the amount of free CPU Time left. It shows the percentage of the tasks ticks that are idle.	
MinCPUFree	A benchmark of the lowest reached value of the CPU free percentage.	
CtrlTicks	This is the number of ticks that have elapsed while the instrument was performing the control Task.	
Max Con Tick	A benchmark of the maximum number of ticks that have elapsed while the instrument was performing the control Task	
Clear Stats	Resets the instrument performance benchmarks.	
ErrCount	The number of errors logged since the last Clear Log. Note: If an error occurs multiple times only the first occurrence will be logged each event will increment the count.	
Err1	The first error to occur	0 There is no error
Err2	The second error to occur	1 Bad or unrecognised module ident. A module has been inserted and has a bad or unrecognised ident. Either the module is damaged or the module is unsupported.
Err3	The third error to occur	3 Factory calibration data bad. The factory calibration data has been read from an I/O module and has not passed the checksum test. Either the module is damaged or has not been initialised.
Err4	The fourth error to occur	4 Module changed for one of a different type. A module has been changed for one of a different type. The configuration may now be incorrect
Err5	The fifth error to occur	10 Calibration data write error. An error has occurred when attempting to write calibration data back to an I/O module's EE. 11 Calibration data read error. An error occurred when trying to read calibration data back from the EE on an I/O module.
Err6	The sixth error to occur	18 Checksum error. The checksum of the NVol Ram has failed. The NVol is considered corrupt and there the instrument configuration may be incorrect. 20 Resistive identifier error. An error occurred when reading the resistive identifier from an i/o module. The module may be damaged.
Err7	The seventh error to occur	43 Invalid custom linearisation table. One of the custom linearisation tables is invalid. Either it has failed checksum tests or the table downloaded to the instrument is invalid.
Err8	The eight error to occur	55 The Instrument wiring is either invalid or corrupt. 56 Non-vol write to volatile. An attempt was made to perform a checksummed write to a non-checksummed area
		58 Recipe load failure. The selected recipe failed to load
		59 Bad User CT calibration data. Corrupted or invalid user calibration data for the current monitor
		60 Bad Factory CT calibration data. Corrupted or invalid factory calibration data for the current monitor
		62 to 65 Slot1 card DFC1 to DFC4 error
		66 to 69 Slot2 card DFC1 to DFC4 error
		70 to 73 Slot3 card DFC1 to DFC4 error
		74 to 77 Slot4 card DFC1 to DFC4 error
Clear Log	Clears the error log entries and count.	
UserStringCount	Number of User Strings Defined	
UserStringCharSpace	Space Available For User Strings.	

Folder: Instrument	Sub-folder: Diagnostics
Name	Parameter Description
Segments Left	Number of Available Program Segments Gives the number of unused program segments. Each time a segment is allocated to a program, this value is reduced by one.
CtrlStack	Control Stack Free Space (words) The number of words of un-used stack for the control task
CommsStack	Comms Stack Free Space (words) The number of words of un-used stack for the comms task
IdleStack	Idle Stack Free Space (words) The number of words of un-used stack for the idle (background) task.
Max segments	Max number of setpoint programmer segments available
MaxSegsPerProg	Specifies the maximum number of segments that can be configured for a single program
CntrlOverrun	Indicates the amount of control overrun.
PSUident	Shows type of PSU fitted 0 = Mains 1= 24V dc
PwrFailCount	Counts the number of times the instrument power has been switched off.
Cust1Name	Name for custom linearisation table 1
Cust2Name	Name for custom linearisation table 2
Cust3Name	Name for custom linearisation table 3

7. Chapter 7 I/O Folder

This lists the modules fitted into the instruments, all the IO channels, the fixed IO and the current monitoring.

The IO folder lists all the channels of each of the IO boards in the 4 available slots. Each board has up to 8 inputs or outputs making a maximum of 32 channels. The channels are listed under Mod1 to Mod32.

Slot	Channels
1	IO.Mod.1 to IO.Mod.8
2	IO.Mod.9 to IO.Mod.16
3	IO.Mod.17 to IO.Mod.24
4	IO.Mod.25 to IO.Mod.32

Note that the current transformer input, CT3, is not included in this arrangement. There is a separate folder for current monitoring under IO.CurrentMonitor. If this board is fitted into slot 2 the IO.Mod.9 to Mod.16 would not exist.

7.1 Module ID

Folder: IO		Sub-folder: ModIDs		
Name	Parameter Description	Value	Default	Access Level
Module1	Module1Ident	0 NoMod - No Module 24 DO8Mod - 8 logic outputs 18 RL8Mod - 8 relay outputs	0	Read Only
Module2	Module2Ident	60 DI8 - 8 logic inputs 90 CT3Mod - 3 current transformer inputs 131 TC8Mod - 8 thermocouple/mV inputs 133 TC4Mod - 4 thermocouple/mV inputs	0	Read Only
Module3	Module3Ident	173 RT4 - 4 PT100 inputs 201 AO8Mod - 8 0-20 mA outputs (Slot 4 only) 203 AO4Mod - 4 0-20 mA outputs (Slot 4 only)	0	Read Only
Module4	Module4Ident		0	Read Only

7.1.1 Modules

The content of the Mod folders depends on the type of IO module fitted in each slot. These will be covered in the following sections.

7.2 Logic Input

Each DI8 card provides 8 logic input channels (voltage controlled) to the system. These can be wired to provide digital inputs to any function block within the system.

7.2.1 Logic Input Parameters

Folder - IO		Sub-folder Mod.1 to .32			
Name	Parameter Description	Value		Default	Access Level
Ident	Channel Identity	LogicIn			Read Only
IOType	IO Type	On/Off	On off input		Conf
Invert	Sets the sense of the logic input	No Yes	No inversion Inverted	No	Conf
Measured Val	Measured Value	On/Off	Value seen at the terminals	Off	Read Only
PV	Process Variable	On/Off	Value after allowing for Invert	Off	Read Only

7.3 Logic Output

If a slot is fitted with a DO8 board then 8 channels will be available to be configured and connected to Loop outputs, alarms or other logic signals.

7.3.1 Logic Out Parameters

Folder - IO		Sub-folder Mod.1 to .32			
Name	Parameter Description	Value		Default	Access Level
Ident	Channel Identity	LogicOut			Read Only
IOType	IO Type	OnOff	On off output		Conf
		Time Prop	Time proportioning output		
Invert	Sets the sense of the logic input or output	No Yes	No inversion Inverted	No	Conf
SbyAct	Action taken by output when instrument goes into Standby Mode	Off, On Continue	Switches On/Off Remains in its last state	Off	Conf
The next five parameters are only shown when 'IO Type' = 'Time Prop' outputs					
MinOnTime	Minimum output on/off time. Prevents relays from switching too rapidly	Auto 0.01 to 150.00 seconds	Auto = 20ms. This is the fastest allowable update rate for the output	Auto	Oper
DisplayHigh	The maximum displayable reading	0.00 to 100.00		100.00	Oper
DisplayLow	The minimum displayable reading	0.00 to 100.00		0.00	Oper
RangeHigh	The maximum (electrical) input/output level	0.00 to 100.00		100	Oper
RangeLow	The minimum (electrical) input/output level	0.00 to 100.00		0	Oper
Always displayed					
MeasuredVal	The current value of the output demand signal to the hardware including the effect of the Invert parameter.	0 1	Off On		Read only
PV	This is the desired output value, before the Invert parameter is applied	0 to 100 or 0 to 1 (OnOff)			Oper

PV can be wired from the output of a function block. For example if it is used for control it may be wired from the control loop output (Ch1 Output).

7.3.2 Logic Output Scaling

If the output is configured for time proportioning control, it can be scaled such that a lower and upper level of PID demand signal can limit the operation of the output value.

By default, the output will be fully off for 0% power demand, fully on for 100% power demand and equal on/off times at 50% power demand. You can change these limits to suit the process. It is important to note, however, that these limits are set to safe values for the process. For example, for a heating process it may be required to maintain a minimum level of temperature. This can be achieved by applying an offset at 0% power demand which will maintain the output on for a period of time. Care must be taken to ensure that this minimum on period does not cause the process to overheat.

If Range Hi is set to a value <100% the time proportioning output will switch at a rate depending on the value - it will not switch fully on.

Similarly, if Range Lo is set to a value >0% it will not switch fully off.

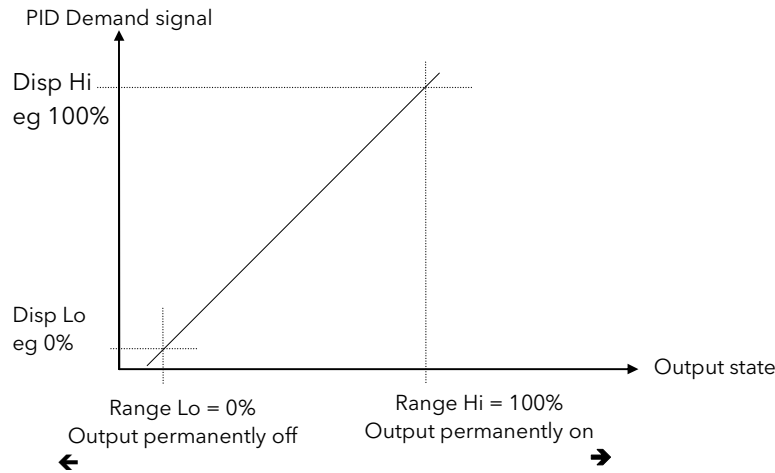

Figure 7-1: Time Proportioning Output

7.3.3 Example: To Scale a Proportioning Logic Output

Access level must be configuration.

Name	Description	Address	Value
Ident	Channel Ident		LogicOut (3)
IOType	IO Type		TimeProp (51)
Invert	Invert		No (0)
MinOnTime	Minimum OnTime	4308	Auto (0)
DisplayHigh	Display High		100.00
DisplayLow	Display Low		0.00
RangeHigh	Range High		90.00
RangeLow	Range Low		8.00
MeasuredVal	Measured Value		0.00
PV	Process Variable	4244	0.00

IO.Mod.17 - 4 parameters (35 hidden)

In this example the output will switch on for 8% of the time when the PID demand wired to 'PV' signal is at 0%. Similarly, it will remain on for 90% of the time when the demand signal is at 100%

7.4 Relay Output

If slot 2 and/or 3 is fitted with a RL8 board then 8 channels will be available to be configured and connected to Loop outputs, alarms or other logic signals.

7.4.1 Relay Parameters

Folder - IO		Sub-folder Mod.9 to .24			
Name	Parameter Description	Value		Default	Access Level
Ident	Channel Identity	Relay			Read Only
IOType	IO Type	OnOff	On off output		Conf
		Time Prop	Time proportioning output		
Invert	Sets the sense of the logic input or output	No Yes	No inversion Inverted	No	Conf
SbyAct	Action taken by output when instrument goes into Standby Mode	Off, On Continue	Switches On/Off Remains in its last state	Off	Conf
The next five parameters are only shown when 'IO Type' = 'Time Prop' outputs					
MinOnTime	Minimum output on/off time. Prevents relays from switching too rapidly	Auto 0.01 to 150.00 seconds	Auto = 220ms. This is the fastest allowable update rate for the output	Auto	Oper
DisplayHigh	The maximum displayable reading	0.00 to 100.00		100.00	Oper
DisplayLow	The minimum displayable reading	0.00 to 100.00		0.00	Oper
RangeHigh	The maximum (electrical) input/output level	0.00 to 100.00		100	Oper
RangeLow	The minimum (electrical) input/output level	0.00 to 100.00		0	Oper
Always displayed					
MeasuredVal	The current value of the output demand signal to the hardware including the effect of the Invert parameter.	0 1	Off On		Read only
PV	This is the desired output value, before the Invert parameter is applied	0 to 100 or 0 to 1 (OnOff)			Oper

7.5 Thermocouple Input

A TC4 offers 4 channels and the TC8 board offers 8 channels which may be configured as thermocouple inputs or mV inputs.

7.5.1 Thermocouple Input Parameters

Folder - IO		Sub-headers: Mod .1 to .32			
Name	Parameter Description	Value		Default	Access Level
Ident	Channel Ident	TCinput			Read Only
IO Type	IO Type	Thermocouple mV	For direct t/c connection For mV inputs, usually linear, scaled to engineering units.		Conf
Lin Type	Input linearisation	see section 7.5.2			Conf
Units	Display units used for units conversion	see section 15.1.2			Conf
Resolution	Resolution	XXXXX to X.XXXX	Sets scaling for digital communications using the SCADA table		Conf
CJC Type	To select the cold junction compensation method	Internal 0°C 45°C 50°C External Off	See description in section 7.5.3. for further details		Internal Conf
SBrk Type	Sensor break type	Low	Sensor break will be detected when its impedance is greater than a 'low' value		Conf
		High	Sensor break will be detected when its impedance is greater than a 'high' value		
		Off	No sensor break		
SBrk Alarm	Sets the alarm action when a sensor break condition is detected	ManLatch	Manual latching	see also the alarm Chapter 8 Alarms	Oper
		NonLatch	No latching		
		Off	No sensor break alarm		
AlarmAck	Sensor Break alarm acknowledge	No Yes		No	Oper
DisplayHigh	The maximum display value in engineering units	-99999 to 99999	For IO Type mV only Limits apply to Linear and SqRoot linearisation. See 7.3.7	100	Oper
DisplayLow	The minimum display value in engineering units	-99999 to 99999		0	Oper
RangeHigh	The maximum (electrical) input mV	RangeLow to 70		70	Oper
RangeLow	The minimum (electrical) input mV	-70 to RangeHigh		0	Oper
Fallback	Fallback Strategy See also section 7.5.5.	Downscale	Meas Value = Input range lo - 5% of the mV signal received from the PV input.		Conf
		Upscale	Meas Value = Input range Hi + 5% of the mV signal received from the PV input.		
		Fall Good	Meas Value = Fallback PV		
		Fall Bad	Meas Value = Fallback PV		
		Clip Good	Meas Value = Input range Hi/lo +/- 5%		
		Clip Bad	Meas Value = Input range Hi/lo +/- 5%		

Folder - IO		Sub-headers: Mod .1 to .32		
Name	Parameter Description	Value	Default	Access Level
Fallback PV	Fallback value See also section 7.5.5.	Instrument range		Conf
Filter Time Constant	Input filter time. An input filter provides damping of the input signal. This may be necessary to prevent the effects of excessive noise on the PV input.	Off to 500:00 (hhh:mm) s:ms to hhh:mm	1s600ms	Oper
Measured Val	The current electrical value of the PV input			R/O
PV	The current value of the PV input after linearisation	Instrument range		R/O
LoPoint	Low Point	Lower cal point (See 7.5.6) Offset at lower point Higher cal point Offset at Higher point	0.0	Oper
LoOffset	Low Offset		0.0	Oper
HiPoint	High Point		0.0	Oper
HiOffset	High Offset		0.0	Oper
Offset	Used to add a constant offset to the PV see section 7.5.7	Instrument range	0.0	Oper
CJC Temp	Reads the temperature of the rear terminals at the thermocouple connection			R/O
SBrk Value	Sensor break Value Used for diagnostics only, and displays the sensor break trip value			R/O
Cal State	Calibration State. Calibration of the PV Input is described in section 22.5	Idle		Conf
Status	PV Status The current status of the PV.	0 - OK 1 - Startup 2 - SensorBreak 4 - Out of range 6 - Saturated 8 - Not Calibrated 25 - No Module	Normal operation Initial startup mode Input in sensor break PV outside operating limits Saturated input Uncalibrated channel No Module	R/O
SbrkOutput	Sensor Break Output	Off /On		R/O

7.5.2 Linearisation Types and Ranges

Input Type		Min Range	Max Range	Units	Min Range	Max Range	Units
J	Thermocouple type J	-210	1200	°C	-346	2192	°F
K	Thermocouple type K	-200	1372	°C	-328	2501	°F
L	Thermocouple type L	-200	900	°C	-328	1652	°F
R	Thermocouple type R	-50	1768	°C	-58	3214	°F
B	Thermocouple type B	0	1820	°C	32	3308	°F
N	Thermocouple type N	-200	1300	°C	-328	2372	°F
T	Thermocouple type T	-250	400	°C	-418	752	°F
S	Thermocouple type S	-50	1768	°C	-58	3214	°F
PL2	Thermocouple Platinel II	0	1369	°C	32	2496	°F
C	Custom						
Linear	mV linear input	-70	70	mV			
SqRoot	Square root						
Custom	Customised linearisation tables						

7.5.3 CJC Type

A thermocouple measures the temperature difference between the measuring junction and the reference junction. The reference junction, therefore, must either be held at a fixed known temperature or accurate compensation be used for any temperature variations of the junction.

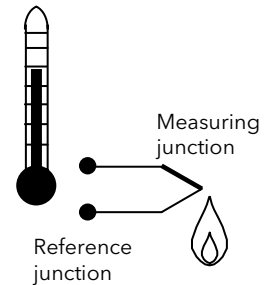

7.5.3.1 Internal Compensation

The controller is provided with a temperature sensing device which senses the temperature at the point where the thermocouple is joined to the copper wiring of the instrument and applies a corrective signal.

Where very high accuracy is needed and to accommodate multi-thermocouple installations, larger reference units are used which can achieve an accuracy of $\pm 0.1^\circ\text{C}$ or better. These units also allow the cables to the instrumentation to be run in copper. The reference units are contained basically under three techniques, Ice-Point, Hot Box and Isothermal.

7.5.3.2 The Ice-Point

There are usually two methods of feeding the EMF from the thermocouple to the measuring instrumentation via the ice-point reference, the bellows type and the temperature sensor type.

The bellows type utilises the precise volumetric increase which occurs when a known quantity of ultra pure water changes state from liquid to solid. A precision cylinder actuates expansion bellows which control power to a thermoelectric cooling device. The temperature sensor type uses a metal block of high thermal conductance and mass, which is thermally insulated from ambient temperatures. The block temperature is lowered to 0°C by a cooling element, and maintained there by a temperature sensing device.

Special thermometers are obtainable for checking the 0°C reference units and alarm circuits that detect any movement from the zero position can be fitted.

7.5.3.3 The Hot Box

Thermocouples are calibrated in terms of EMF generated by the measuring junctions relative to the reference junction at 0°C . Different reference points can produce different characteristics of thermocouples, therefore referencing at another temperature does present problems. However, the ability of the hot box to work at very high ambient temperatures, plus a good reliability factor has led to an increase in its usage. The unit can consist of a thermally insulated solid aluminium block in which the reference junctions are embedded.

The block temperature is controlled by a closed loop system, and a heater is used as a booster when initially switching on. This booster drops out before the reference temperature, usually between 55°C and 65°C , is reached, but the stability of the hot box temperature is now important. Measurements cannot be taken until the hot box reaches the correct temperature.

7.5.3.4 Isothermal Systems

The thermocouple junctions being referenced are contained in a block which is heavily thermally insulated. The junctions are allowed to follow the mean ambient temperature, which varies slowly. This variation is accurately sensed by electronic means, and a signal is produced for the associated instrumentation. The high reliability factor of this method has favoured its use for long term monitoring.

7.5.3.5 CJC Options in Mini8 Controller Series

- 0 - Internal CJC measurement at instrument terminals
- 1 - 0C CJC based on external junctions kept at 0C (Ice Point)
- 2 - 45C CJC based on external junctions kept at 45C (Hot Box)
- 3 - 50C CJC based on external junctions kept at 50C (Hot Box)
- 4 - External CJC based on independent external measurement
- 5 - Off CJC switched off

7.5.4 Sensor Break Value

The controller continuously monitors the impedance of a transducer or sensor connected to any analogue input. This impedance, expressed as a % of the impedance which causes the sensor break flag to trip, is a parameter called 'SBrkValue'.

The table below shows the typical impedance which causes sensor break to trip for various types of input and high and low SBrk Impedance readings. The impedance values are only approximate ($\pm 25\%$) as they are not factory calibrated.

TC4/TC8 Input Range -77 to +77mV	SBrk Impedance - High	~ 12K Ω
	SBrk Impedance - Low	~ 3K Ω

7.5.5 Fallback

A Fallback strategy may be used to configure the default value for the PV in case of an error condition. The error may be due an out of range value, a sensor break, lack of calibration or a saturated input.

The Status parameter would indicate the error condition and could be used to diagnose the problem.

Fallback has several modes and may be associated with the Fallback PV parameter

The Fallback PV may be used to configure the value assigned to the PV in case of an error condition. The Fallback parameter should be configured accordingly.

The fallback parameter may be configured so as to force a Good or Bad status when in operation. This in turn allows the user to choose to override or allow error conditions to affect the process.

7.5.6 User Calibration (Two Point)

All ranges of the controller have been calibrated against traceable reference standards. However in a particular application it may be necessary to adjust the displayed reading to overcome other effects within the process. A two point calibration is offered allowing offset and slope adjustment. This is most useful where the setpoints used in a process cover a wide range. The Low and High points should be set on or near the extremities of the range.

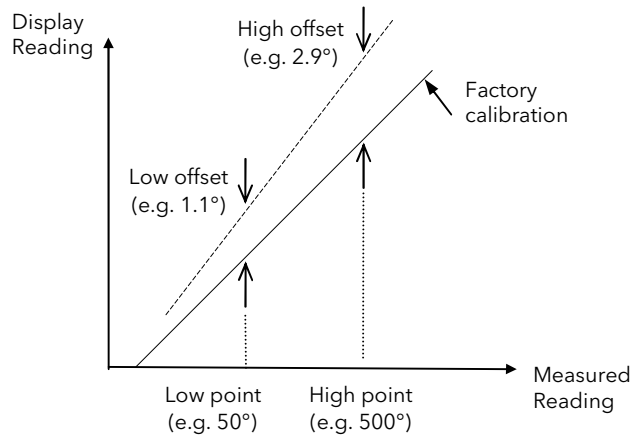

7.5.7 PV Offset (Single Point)

All ranges of the controller have been calibrated against traceable reference standards. This means that if the input type is changed it is not necessary to calibrate the controller. There may be occasions, however, when you wish to apply an offset to the standard calibration to take account of known errors within the process, for example, a known sensor error or a known error due to the positioning of the sensor. In these instances it is not advisable to change the reference calibration, but to apply a user defined offset.

A single point offset is most useful where the process setpoint remains at nominally the same value.

PV Offset applies a single offset over the full display range of the controller and can be adjusted in Operator Mode. It has the effect of moving the curve up a down about a central point as shown in the example below:-

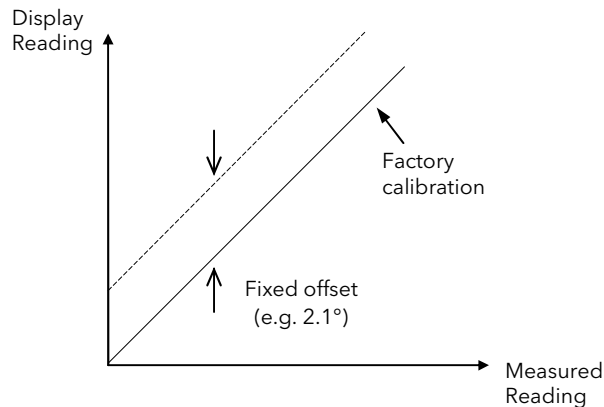

7.5.7.1 Example: To Apply an Offset:-

- Connect the input of the controller to the source device which you wish to calibrate to
- Set the source to the desired calibration value
- The controller will show the current measurement of the value
- If the value is correct, the controller is correctly calibrated and no further action is necessary. If you wish to offset the reading use the Offset parameter where

$$\text{Corrected value (PV)} = \text{input value} + \text{Offset.}$$

7.5.8 Using TC4 or TC8 channel as a mV input

Example – a pressure sensor provides 0 to 33mV for 0 to 200 bar.

1. Set IO type as mV
2. Set the Linearisation Type as Linear
3. Set DisplayHigh to 200 (bar)
4. Set DisplayLow to 0 (bar)
5. Set RangeHigh to 33 mV
6. Set RangeLow to 0 mV

Name	Description	Address	Value	Wired From
Ident	Channel Ident		TcInput (6)	
IOType	IO Type		mV (13)	
LinType	Linearisation Type		Linear (11)	
Units	Units		Bar (9)	
Resolution	Resolution		XX (1)	
SBrkType	Sensor Break Type		Low (1)	
SBrkAlarm	Sensor break alarm		NonLatching (1)	
SBrkOut	Sensor Break Alarm Output		Off (0)	
AlarmAck	Sensor break alarm acknowl	4260	No (0)	
DisplayHigh	Display High		200.00	
DisplayLow	Display Low		0.00	
RangeHigh	Range High		33.00	
RangeLow	Range Low		0.00	
Fallback	Fallback Strategy		UpScaleBad (4)	
FallbackPV	Fallback Value		0.00	
FilterTimeConst	Filter Time Constant		1s 600ms ...	
MeasuredVal	Measured Value		0.00	
PV	Process Variable	4228	0.01	
LoPoint	Low Point	4324	0.00	
LoOffset	Low Offset	4356	0.00	
HiPoint	High Point	4388	0.00	
HiOffset	High Offset	4420	0.00	
Offset	PV Offset		0.00	
SBrkValue	Sensorbreak Value		0.78	
CalState	Calibration State		Idle (21)	

IO.Mod.1 - 26 parameters (18 hidden)

Note maximum input range is ± 70 mV

7.6 Resistance Thermometer Input

The RT4 module offers 4 resistance inputs which can be linear or PT100.

7.6.1 RT Input Parameters

Folder - IO		Sub-headers: Mod .1 to .32			
Name	Parameter Description	Value		Default	Access Level
Ident	Channel Ident	RTinput			Read Only
IO Type	IO Type	RTD2 RTD3 RTD4	For 2 wire, 3 wire or 4 wire connections.		Conf
Lin Type	Linearisation Type	See section 7.6.2			Conf
Units	Display units used for units conversion	See section 15.1.2			Conf
Resolution	Resolution	XXXXX to X.XXXX	Sets scaling for digital communications using the SCADA table		Conf
SBrk Type	Sensor break type	Low	Sensor break will be detected when its impedance is greater than a 'low' value		Conf
		High	Sensor break will be detected when its impedance is greater than a 'high' value		
		Off	No sensor break		
SBrk Alarm	Sets the alarm action when a sensor break condition is detected	ManLatch	Manual latching	see also the alarm Chapter 8 Alarms	Oper
		NonLatch	No latching		
		Off	No sensor break alarm		
AlarmAck	Sensor Break alarm acknowledge	No Yes		No	Oper
Fallback	Fallback Strategy See also section 7.5.5.	Downscale	Meas Value = Input range lo - 5%		Conf
		Upscale	Meas Value = Input range Hi + 5%		
		Fall Good	Meas Value = Fallback PV		
		Fall Bad	Meas Value = Fallback PV		
		Clip Good	Meas Value = Input range Hi/lo +/- 5%		
		Clip Bad	Meas Value = Input range Hi/lo +/- 5%		
Fallback PV	Fallback value See also section 7.5.5.	Instrument range			Conf
Filter Time Constant	Input filter time. An input filter provides damping of the input signal. This may be necessary to prevent the effects of excessive noise on the PV input.	Off to 500:00 (hhh:mm) s:ms to hhh:mm		1.6 seconds	Oper
Measured Val	The current electrical value of the PV input				R/O
PV	The current value of the PV input after linearisation	Instrument range			R/O
LoPoint	Low Point	Lower cal point (See section 7.5.6) Offset at lower cal point Higher cal point Offset at Higher cal point		0.0	Oper
LoOffset	Low Offset			0.0	Oper
HiPoint	High Point			0.0	Oper
HiOffset	High Offset			0.0	Oper
Offset	Used to add a constant offset to the PV see section 7.5.7			Instrument range	
SBrk Value	Sensor break Value Used for diagnostics only, and displays the sensor break trip value				R/O

Folder - IO		Sub-headers: Mod .1 to .32			
Name	Parameter Description	Value		Default	Access Level
Cal State	Calibration State. Calibration of the PV Input is described in Chapter 22.5	Idle			Conf
Status	PV Status The current status of the PV.	0 - OK 1 - Startup 2 - SensorBreak 4 - Out of range 6 - Saturated 8 - Not Calibrated 25 - No Module	Normal operation Initial startup mode Input in sensor break PV outside operating limits Saturated input Uncalibrated channel No Module		R/O
SbrkOutput	Sensor Break Output	Off /On			R/O

7.6.2 Linearisation Types and Ranges

Input Type		Min Range	Max Range	Units	Min Range	Max Range	Units
PT100	100 ohm platinum bulb	-200	850	°C	-328	1562	°F
Linear	Linear	50	450	ohms			

7.6.3 Using RT4 as mA input

Wire the input with a 2.49 ohm resistor as shown in 1.4.13.

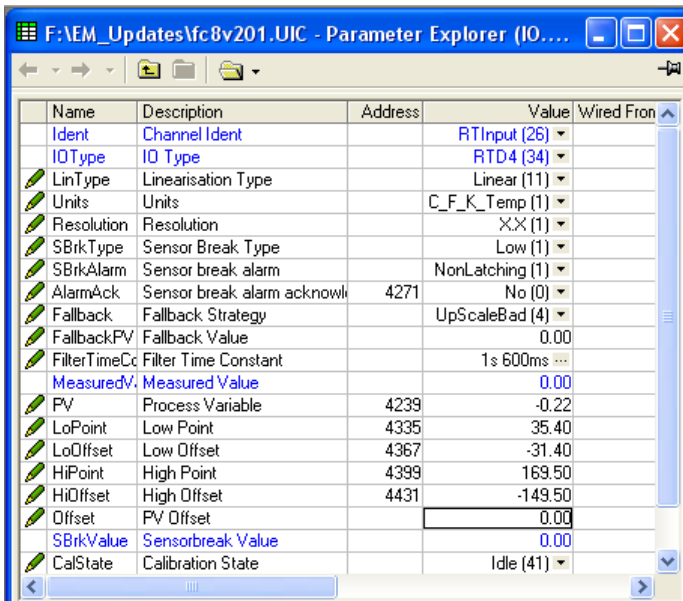

The PV is mapped from the input using User Cal - see section 7.5.6

Approximate Values for 4-20mA input with 2.49 ohm resistor.

PV range	4 to 20	0 to 100
LoPoint	35.4	35.4
LoOffset	-31.4	-35.4
HiPoint	169.5	169.5
HiOffset	-149.5	-69.5

For best accuracy the input should be calibrated against a reference.

7.7 Analogue Output

The AO4 offers 4 channels and the AO8 module 8 channels which maybe configured as mA outputs. An AO4 or AO8 may only be fitted in Slot 4.

Folder - IO		Sub-folder: Mod.25 to Mod.32			
Name	Parameter Description	Value		Default	Access Level
Ident	Channel ident	mAout			R/O
IO Type	To configure the output drive signal	mA	milli-amps dc		Conf
Resolution	Display resolution	XXXXX to X.XXXX	Determines scaling for SCADA communications		Conf
Disp Hi	Display high reading	-99999 to 99999 decimal points depend on resolution		100	Oper
Disp Lo	Display low reading			0	Oper
Range Hi	Electrical high input level	0 to 20		20	Oper
Range Lo	Electrical low input level			4	Oper
Meas Value	The current output value				R/O
PV					Oper
Status	PV Status The current status of the PV.	0 - OK 1 - Startup 2 - SensorBreak 4 - Out of range 6 - Saturated 8 - Not Calibrated 25 - No Module	Normal operation Initial startup mode Input in sensor break PV outside operating limits Saturated input Uncalibrated channel No Module		R/O

7.7.1 Example - 4 to 20mA Analogue Output

In this example 0% (=Display Low) to 100% (=Display High) from a Loop PID Output is wired to this output channel PV input which will give a 4mA (=Range Low) to 20mA (=Range High) control signal.

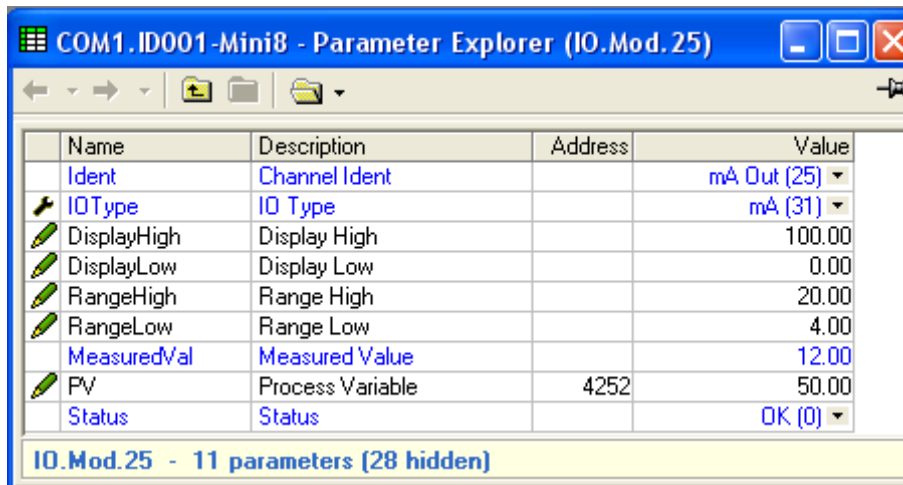

Here the PID demand is 50% giving a MeasuredVal output of 12mA.

7.8 Fixed IO

There are two digital inputs, designated D1 and D2.

Folder: IO		Sub-folder: Fixed IO.D1 and .D2			
Name	Parameter Description	Value		Default	Access Level
Ident	Channel Ident	LogicIn		LogicIn	Read Only
IO Type	IO Type	Input		Input	Read Only
Invert	Invert	No/Yes - input sense is inverted		No	Conf
Measured Val	Measured Value	On/Off	Value seen at the terminals	Off	Read Only
PV	Process Variable	On/Off	Value after allowing for Invert	Off	Read Only

There are two fixed relay outputs, designated A and B

Folder: IO		Sub-folder: Fixed IO.A and .B			
Name	Parameter Description	Value		Default	Access Level
Ident	Channel Ident	Relay		Relay	Read Only
IO Type	IO Type	OnOff		OnOff	Read Only
Invert	Invert	No/Yes = output sense is inverted.		No	Conf
Measured Val	Measured Value	On/Off	Value seen at the terminals after allowing for Invert.	Off	Read Only
PV	Process Variable	On/Off	Requested output before Invert	Off	Oper
SbyAct	Action taken by output when instrument goes into Standby Mode	Off, On Continue	Switches On/Off Remains in its last state	Off	Conf

7.9 Current Monitor

The Mini8 controller, with a CT3 card, has the capability of detecting failures of up to 16 heater loads by measuring the current flowing through them via 3 current transformer inputs. The failures that can be detected are:

SSR Fault

If current is detected flowing through the heater when the controller is requesting it to be off then this indicates that the SSR has a short circuit fault. If current is not detected when the controller is requesting the heater to be on it indicates that the SSR has an open circuit fault.

Partial Load Fault (PLF)

If less current is detected flowing through the heater than the PLF threshold, which has been set for that channel, then this indicates that the heater has a fault; in applications that use multiple heater elements in parallel then it indicates that one or more of the elements has an open circuit fault.

Over Current Fault (OCF)

If more current is detected flowing through the heater than the OCF threshold then this indicates that the heater has a fault; in applications that use multiple heater elements in parallel then it indicates that one or more of the elements has lower than expected resistance value.

It should be noted that if the loop associated with a CT monitored output is inhibited, then that output will be excluded from the CT measurements and fault detection.

Heater failures are indicated via individual load status parameters and via four status words. In addition, a global alarm parameter will indicate when a new CT alarm has been detected, which, will also be registered in the alarm log.

7.9.1 Current Measurement

Individual LoadCurrent parameters indicate the current measured for each heater. The Current Monitor function block utilises a cycling algorithm to measure the current flowing through one heater per measurement interval (default 10s, user alterable). Compensation within the control loop minimises the disturbance to the PV when current through a load is being measured.

Name	Description	Value
Load1Status	Load1 Status	Ok (0)
Load1Current	Load1 current	4.185859
Load2Status	Load2 Status	Ok (0)
Load2Current	Load2 current	3.813231
Load3Status	Load3 Status	Ok (0)
Load3Current	Load3 current	3.821723
Ph1AllOff	Phase1 All Off Current	0.012421
Ph2AllOff	Phase2 All Off Current	0.037263
Ph3AllOff	Phase3 All Off Current	0.012328

The interval between successive measurements is dependent upon the average output power required to maintain SP. The recommended absolute minimum interval can be calculated as follows:

$$\text{Minimum interval (s)} > 0.25 * (100/\text{average output power to maintain SP}).$$

For example, if average output power to maintain SP is 10%, using the above rule, the recommended minimum interval is 2.5 seconds. The interval may need to be adjusted depending upon the response of the heaters being used.

7.9.2 Single Phase Configurations

7.9.2.1 Single SSR triggering

With this configuration, failures of individual heater loads can be detected. For example, if the current detected flowing through Heater 3 is less than its PLF threshold then this will be indicated as Load3PLF.

Example1 - Using one CT input

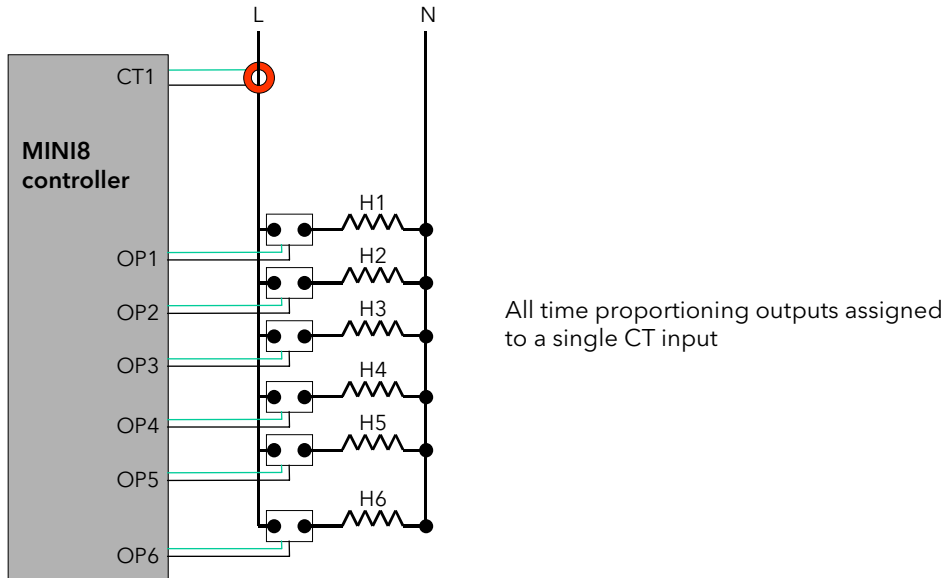

Note: Maximum of 6 Heaters can be connected to one CT input

Example2 - Using three CT inputs

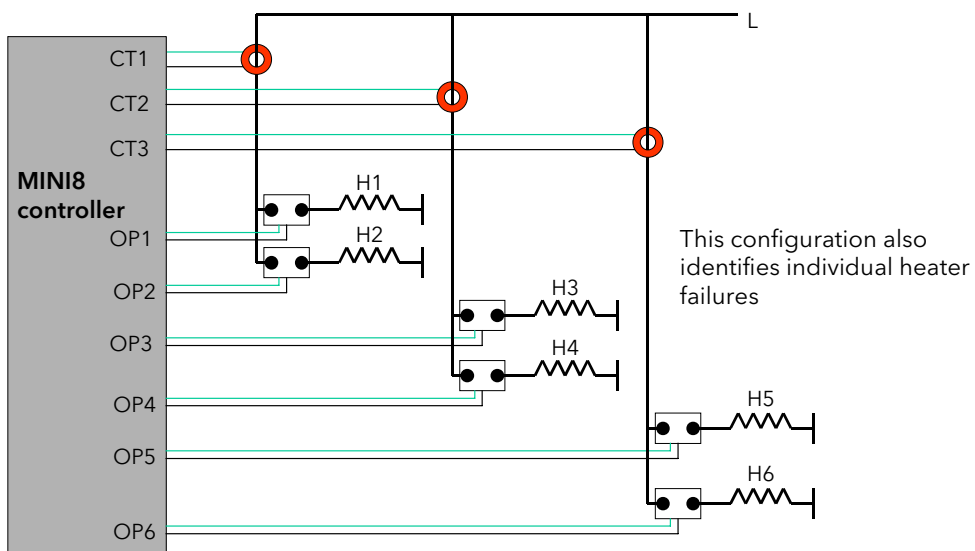

7.9.2.2 Multiple SSR triggering

With this configuration, failure of a set of heater loads can be detected. For example, if the current detected flowing through Heater Set 1 is less than Load1's PLF threshold then this will be indicated as Load1PLF. Further investigation will then be required to determine which heater within Set 1 has failed.

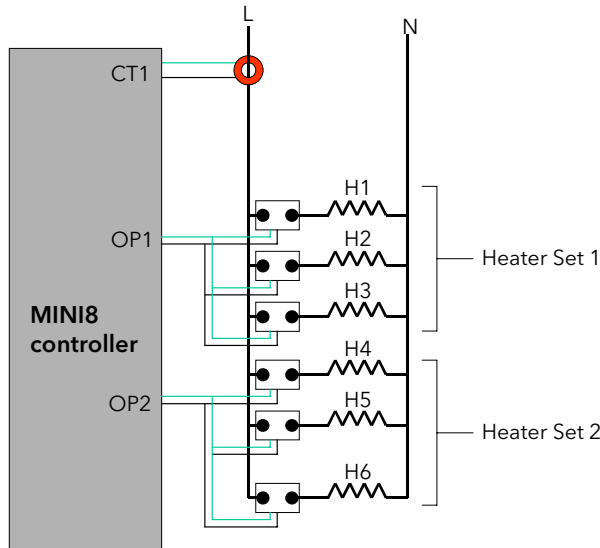

7.9.2.3 Split Time Proportioning Outputs

This is where a single power demand is split and applied to two time proportioning outputs, that have been scaled, allowing the loads to switch on incrementally as the output power increases. For example, Heater1 will deliver any demand from 0-50%, and Heater2 will deliver any demand from 50-100% (with Heater1 fully on).

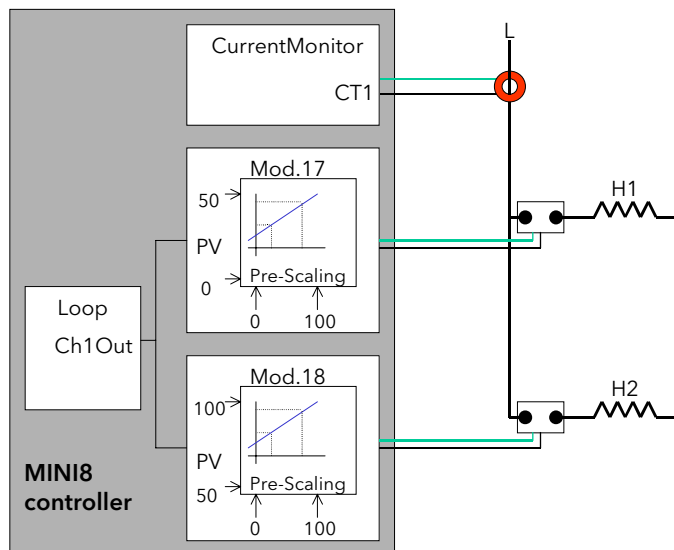

As the Mini8 controller has the capability of detecting faults with up to 16 heater loads it can handle this type of application even if all 8 loops have split time proportioning outputs.

7.9.3 Three Phase Configuration

Configuration for Three Phase supply applications is similar to that for Single phase using three CT inputs.

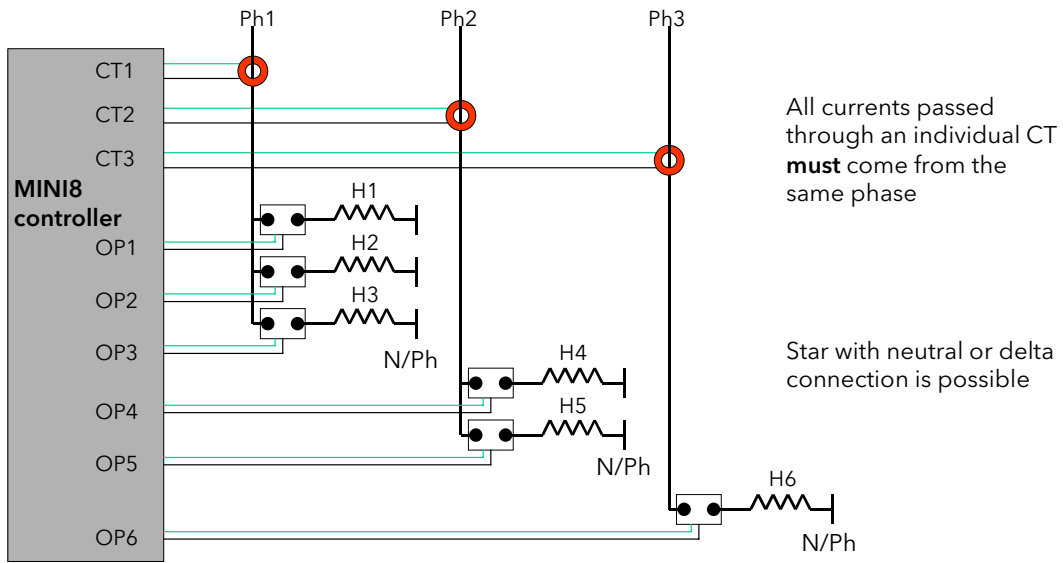

Note: Maximum of 6 Heaters can be connected to one CT input

7.9.4 Parameter Configuration

If Current Monitor is enabled in the folder Instrument/Options/Current Monitor then the current monitor configuration folder appears as a subfolder in IO.

Folder: IO		Sub-folder: CurrentMonitor/Config			
Name	Parameter Description	Value	Default	Access Level	
Commission	Commission CT	No Auto Manual Accept Abort	No	Oper	
CommissionStatus	Commission Status	Not commissioned	Not commissioned	0	Read Only
		Commissioning	Commissioning in progress		
		NoDO8orRL8cards	There are no DO8/RL8 cards installed in the instrument.		
		NoloopTPouts	The digital outputs are either not configured as time proportioning or are not wired from loop heater channels.		
		SSRfault	Either a SSR short circuit or open circuit fault is present.		
		MaxLoadsCT1/2/3	More than 6 heaters have been connected to CT input 1 or 2 or 3.		
		NotAccepted	Commissioning failed		
		Passed	Successfully auto commissioned		
		ManuallyConfigured	Configured manually		
Interval	Measurement Interval	1s to 1m	10s	Oper	
Inhibit	Inhibit	No - current is measured Yes -current measurement is inhibited	No	Oper	
MaxLeakPh1	Max Leakage Current Phase 1	0.25 to 1 amp	0.25	Oper	
MaxLeakPh2	Max Leakage Current Phase 2	0.25 to 1 amp	0.25	Oper	
MaxLeakPh3	Max Leakage Current Phase 3	0.25 to 1 amp	0.25	Oper	
CT1Range*	CT input 1 range	10 to 1000 amps (Ratio to 50mA)	10	Oper	
CT2Range*	CT input 2 range	10 to 1000 amps (Ratio to 50mA)	10	Oper	
CT3Range*	CT input 3 range	10 to 1000 amps (Ratio to 50mA)	10	Oper	
CalibrateCT1	Calibrate CT1	Idle See section 22.5 0mA -70mA LoadFactorCal SaveUserCal	Idle	Oper	
CalibrateCT2	Calibrate CT2	As CT1	Idle	Oper	
CalibrateCT3	Calibrate CT3	As CT1	Idle	Oper	

- The current rating of the CT used for each of the CT input channels should cover only the single largest load current proposed for its group of heaters. e.g. if CT1 has heaters of 15A, 15A & 25A it would need a CT capable of at least 25A.

7.9.5 Commissioning

7.9.5.1 Auto Commission

Auto commissioning of the Current Monitor is a feature that automatically detects which time proportioning outputs drive individual heaters (or heater sets), detects which CT input individual heaters are associated with and determines the Partial Load and Over Current thresholds using a 1:8 ratio. If auto commissioning fails, a status parameter indicates the reason why.

Note: In order for the auto commissioning to operate successfully the process must be enabled for full operation of the heating circuit with the digital outputs configured as Time Proportioning and 'soft' wired to the appropriate loop heater channels. During auto commissioning digital outputs will switch on and off.

How to Auto Commission

1. Put instrument into Operator Mode.
2. Set Commission to Auto and CommissionStatus will display 'Commissioning'.
3. If successful, CommissionStatus will display Passed and configured load parameters will become available. If unsuccessful, CommissionStatus displays the offending fault.

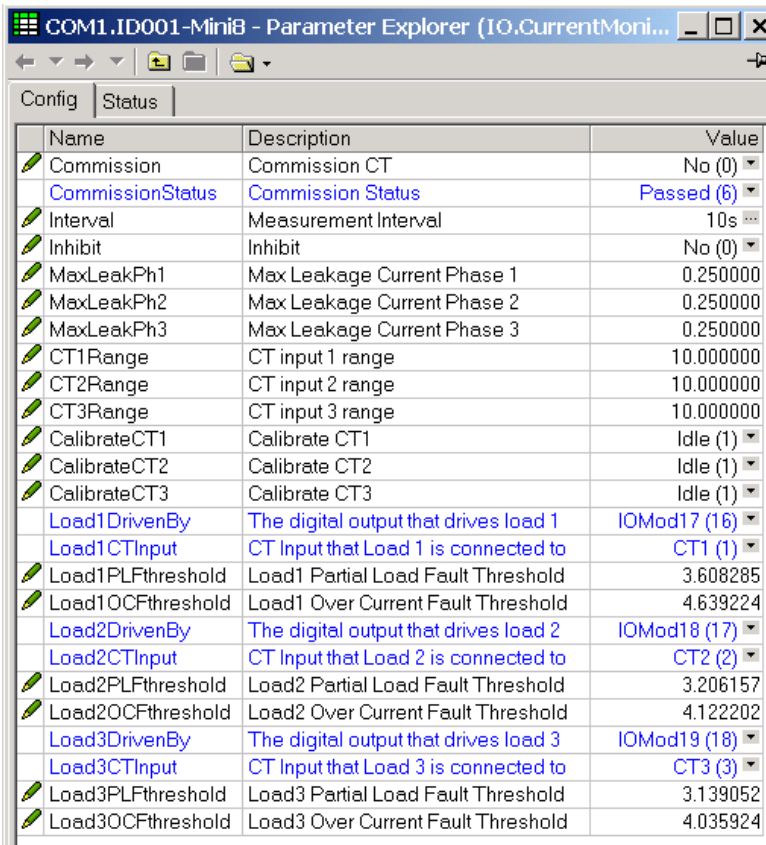

If unsuccessful, CommissionStatus displays the offending fault:

NoDO8orRL8Cards	Indicates that there are no DO8 or RL8 cards installed in the instrument.
NoLoopTPOuts	Indicates that the digital outputs are either not configured as time proportioning or are not wired from loop heater channels.
SSRFault	Indicates that either a SSR short circuit or open circuit fault is present.
MaxLoadsCT1 (or 2,3)	Indicates that more than 6 heaters have been connected to CT input 1 (or 2,3)

7.9.5.2 Manual Commission

Manual Commissioning is also available and is intended for those users who want to commission the Current Monitor off-line or do not want to accept auto commissioned settings.

How to Manual Commission

1. Set Commission to Manual. CommissionStatus will display Commissioning and Load1 configuration parameters will become available

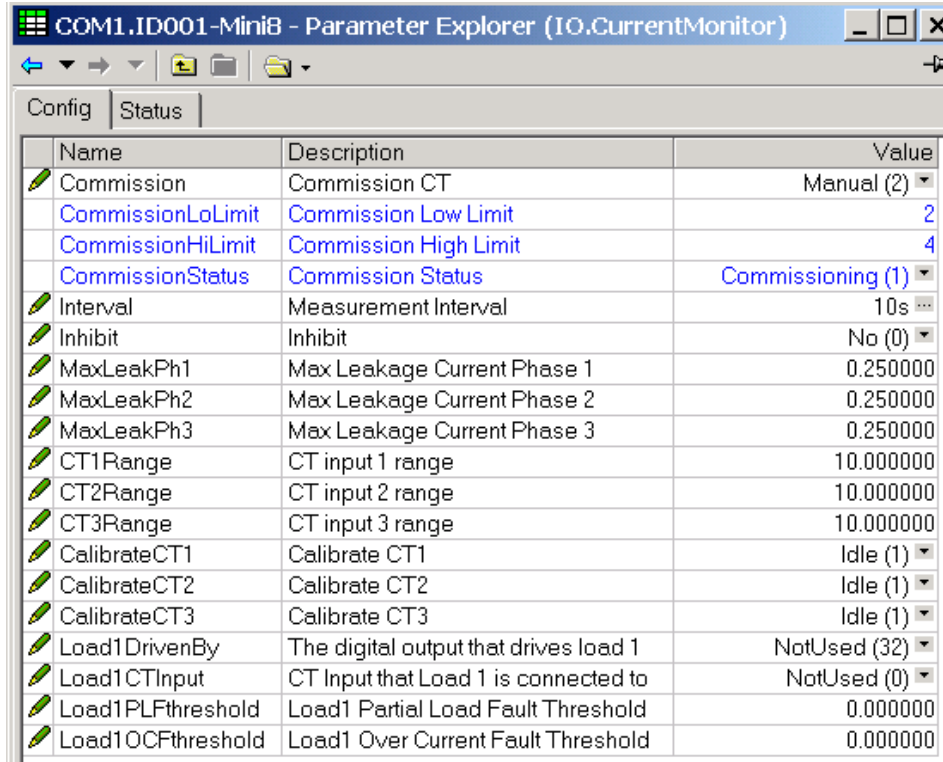

Name	Description	Value
Commission	Commission CT	Manual (2)
CommissionLoLimit	Commission Low Limit	2
CommissionHiLimit	Commission High Limit	4
CommissionStatus	Commission Status	Commissioning (1)
Interval	Measurement Interval	10s
Inhibit	Inhibit	No (0)
MaxLeakPh1	Max Leakage Current Phase 1	0.250000
MaxLeakPh2	Max Leakage Current Phase 2	0.250000
MaxLeakPh3	Max Leakage Current Phase 3	0.250000
CT1Range	CT input 1 range	10.000000
CT2Range	CT input 2 range	10.000000
CT3Range	CT input 3 range	10.000000
CalibrateCT1	Calibrate CT1	Idle (1)
CalibrateCT2	Calibrate CT2	Idle (1)
CalibrateCT3	Calibrate CT3	Idle (1)
Load1DrivenBy	The digital output that drives load 1	NotUsed (32)
Load1CTInput	CT Input that Load 1 is connected to	NotUsed (0)
Load1PLFthreshold	Load1 Partial Load Fault Threshold	0.000000
Load1OCFthreshold	Load1 Over Current Fault Threshold	0.000000

2. Set Load1DrivenBy to the IO Module that is connected to the heater load.
3. Set Load1CTInput to the CT input number that is connected to the heater load.
4. Set Load1PLFthreshold and Load1OCFthreshold to appropriate values for the heater load.
5. Repeat for other loads.
6. To use the commissioned settings set Commission to 'Accept'. CommissionStatus will display ManuallyConfigured.
7. To stop manual commissioning set Commission to 'Abort'. CommissionStatus will display NotCommissioned.

7.9.6 Calibration

A Mini8 controller supplied from factory with the CT3 card already installed the CT inputs will have been factory calibrated. If the CT3 card is installed at a later date then default calibration values are automatically loaded into the instrument. However, three calibration parameters, one for each CT input, are provided to allow the inputs to be calibrated in the field.

Note: DC Current Source, capable of outputting a -70mA signal, is required to calibrate the inputs.

The 3 CT inputs are calibrated individually.

How to Calibrate

1. Apply the stimulus (0mA or -70mA) from the DC current source to the CT input to be calibrated.
2. Set CalibrateCT1, to reflect the stimulus being applied to the input.
3. CalibrateCT1 displays 'Confirm'. Select 'Go' to proceed with the calibration process.
4. After selecting Go, CalibrateCT1 displays 'Calibrating'.
5. If calibration was successful, CalibrateCT1 displays 'Passed'. Select 'Accept' to keep the calibration values.
6. If calibration was unsuccessful, CalibrateCT1 displays 'Failed'. Select 'Abort' to reject the calibration.
7. Select 'SaveUserCal' to save the calibration values into non-volatile memory.
8. Select 'LoadFactCal' to restore calibration values to the factory calibrated or default settings.
9. Note: It is possible to stop the calibration process at anytime by selecting 'Abort'.

Follow the same procedure for CT2 and CT3.

8. Chapter 8 Alarms

Alarms are used to alert the system when a pre-set level has been exceeded or a particular condition has changed state. As the Mini8 controller has no display to show alarms the alarm flags are all available over communications in status words See Alarm Summary (Section 8.7). They may also be wired directly or via logic to an output such as a relay.

Alarms can be divided into two main types. These are:-

Analogue alarms - operate by monitoring an analogue variable such as the process variable and comparing it with a set threshold.

Digital alarms - operate when the state of a boolean variable changes, for example, sensor break.

Number of Alarms - up to 32 analogue and 32 digital alarms may be configured.

8.1 Further Alarm Definitions

Hysteresis	is the difference between the point at which the alarm switches 'ON' and the point at which it switches 'OFF'. It is used to provide a definite indication of the alarm condition and to prevent alarm relay chatter.	
Latch	used to hold the alarm condition once an alarm has been detected. It may be configured as:-	
	None Non latching	A non latching alarm will reset itself when the alarm condition is removed
	Auto Automatic	An auto latching alarm requires acknowledgement before it is reset. The acknowledgement can occur BEFORE the condition causing the alarm is removed.
	Manual Manual	The alarm continues to be active until both the alarm condition is removed AND the alarm is acknowledged. The acknowledgement can only occur AFTER the condition causing the alarm is removed.
	Event Event	Alarm output will activate.
Block	The alarm may be masked during start up. Blocking prevents the alarm from being activated until the process has first achieved a safe state. It is used, for example, to ignore start up conditions which are not representative of running conditions. A blocking alarm is re-initiated after a setpoint change.	
Delay	A short time can be set for each alarm which prevents the output from going into the alarm state. The alarm is still detected as soon as it occurs, but if it cancels before the end of the delay period then no output is triggered. The timer for the delay is then reset. It is also reset if an alarm is changed from being inhibited to uninhibited.	

8.2 Analogue Alarms

Analogue alarms operate on variables such as PV, output levels, etc. They can be soft wired to these variables to suit the process.

8.2.1 Analogue Alarm Types

Absolute High - an alarm occurs when the PV exceeds a set high threshold.

Absolute Low - an alarm occurs when the PV exceeds a set low threshold.

Deviation High - an alarm occurs when the PV is higher than the setpoint by a set threshold

Deviation Low - an alarm occurs when the PV is lower than the setpoint by a set threshold

Deviation Band - an alarm occurs when the PV is higher or lower than the setpoint by a set threshold

These are shown graphically below for changes in PV plotted against time. (Hysteresis set to zero)

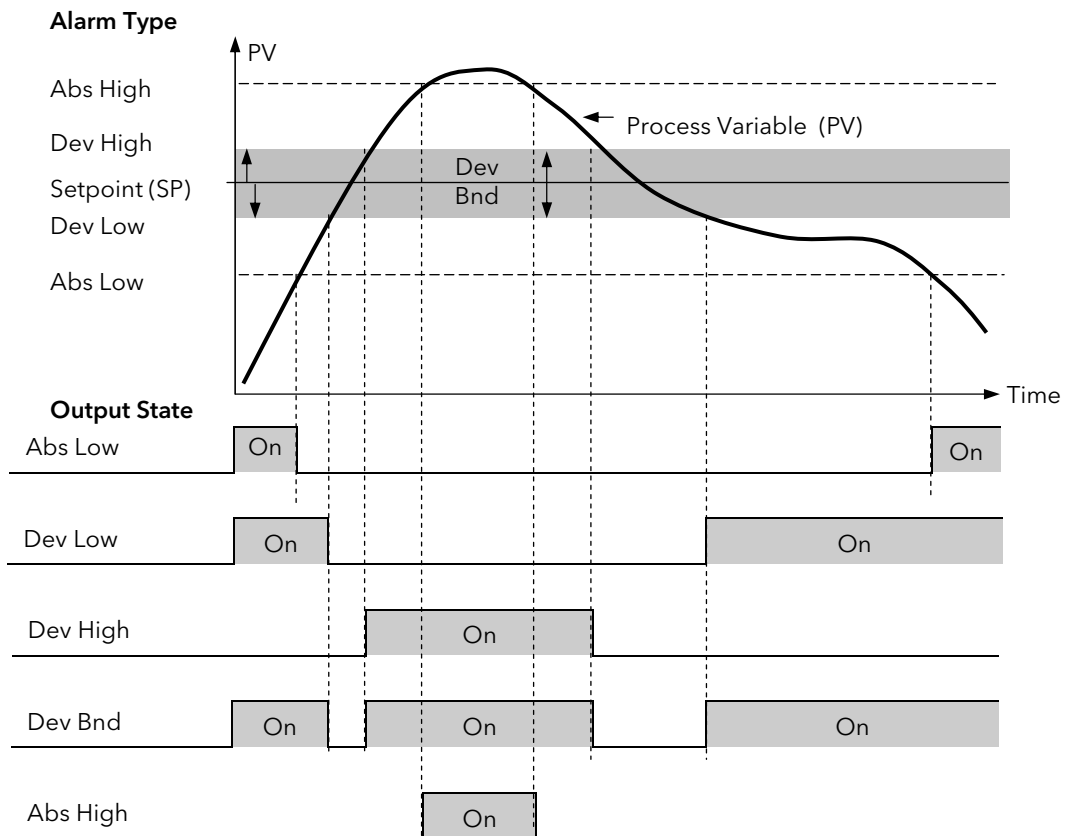

8.3 Digital Alarms

Digital alarms operate on Boolean variables. They can be soft wired to any suitable Boolean parameter such as digital inputs or outputs.

8.3.1 Digital Alarm Types

Pos Edge	The alarm will trigger when the input changes from a low to high condition
Neg Edge	The alarm will trigger when the input changes from a high to low condition
Edge	The alarm will trigger on any change of state of the input signal
High	The alarm will trigger when the input signal is high
Low	The alarm will trigger when the input signal is low

8.4 Alarm Outputs

Alarms can operate a specific output (usually a relay). Any individual alarm can operate an individual output or any combination of alarms can operate an individual output. They are wired as required in configuration level.

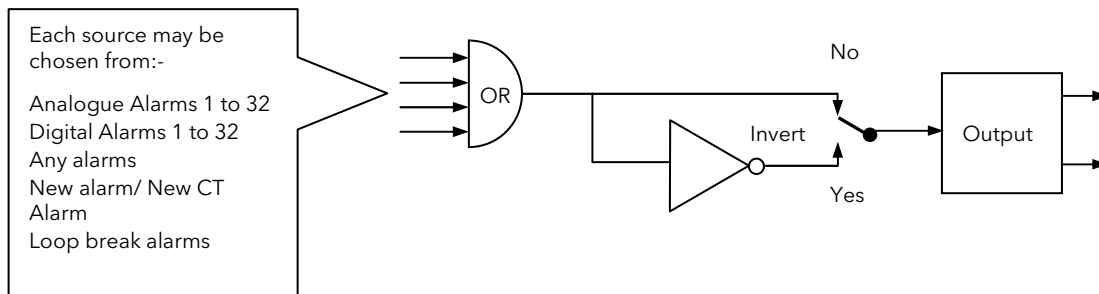

8.4.1 How Alarms are Indicated

Alarm states are all embedded in 16 bit status words. See Alarm Summary in Section 8.7

8.4.2 To Acknowledge an Alarm

Set the appropriate alarm acknowledge flag to acknowledge that particular alarm. Alternatively the GlobalAck in the AlmSummary folder can be used to acknowledge ALL alarms that require acknowledging in the instrument.

The action, which now takes place, will depend on the type of latching, which has been configured.

8.4.2.1 Non Latched Alarms

If the alarm condition is present when the alarm is acknowledged, the alarm output will be continuously active. This state will continue for as long as the alarm condition remains. When the alarm condition clears the output will go off. If the alarm condition clears before it is acknowledged the alarm output goes off as soon as the condition disappears.

8.4.2.2 Automatic Latched Alarms

The alarm continues to be active until both the alarm condition is removed AND the alarm is acknowledged. The acknowledgement can occur **BEFORE** the condition causing the alarm is removed.

8.4.2.3 Manual Latched Alarms

The alarm continues to be active until both the alarm condition is removed AND the alarm is acknowledged. The acknowledgement can only occur **AFTER** the condition causing the alarm is removed.

8.5 Alarm Parameters

Four groups of eight **analogue** alarms are available. The following table shows the parameters to set up and configure alarms.

Folder: Alarm		Sub-folders: 1 to 32			
Name	Parameter Description	Value		Default	Access Level
Type	Selects the type of alarm	None	Alarm not configured		Conf
		Abs Hi	Full Scale High		
		Abs Lo	Full Scale Low		
		Dev Hi	Deviation High		
		Dev Lo	Deviation Low		
		Dv Bnd	Deviation band		
In	This is the parameter that will be monitored and compared against the threshold value to see if an alarm condition has occurred	Instrument range			Oper
Reference	The reference value is used in deviation alarms and the threshold is measured from this reference and not from its absolute value.	Instrument range			Oper
Threshold	The threshold is the value that the input is compared against to determine if an alarm has occurred.	Instrument range			Oper
Out	The output indicates whether the alarm is on or off depending on: the alarm condition, latching and acknowledge, inhibiting and blocking.	Off	Alarm output deactivated		R/O
		On	Alarm output activated		
Inhibit	Inhibit is an input to the Alarm function. It allows the alarm to be switched OFF. Typically the Inhibit is connected to a digital input or event so that during a phase of the process alarms do not activate. For Example, if the door to a furnace is opened the alarms may be inhibited until the door is closed again.	No Yes	Alarm not inhibited Inhibit function active		Oper
Hysteresis	Hysteresis is used to prevent signal noise from causing the Alarm output to oscillate. Alarm outputs become active as soon as the PV exceeds the Alarm Setpoint. They return to inactive after the PV has returned to the safe region by more than the hysteresis value. Typically the Alarm hysteresis is set to a value that is greater than the oscillations seen on the instrument display	Instrument range			Oper
Latch	Determine the type of latching the alarm will use, if any. Auto latching allows acknowledgement while the alarm condition is still active, whereas manual latching needs the condition to revert back to safe before the alarm can be acknowledged. See also the description at the beginning of this chapter	None	No latching is used		Oper
		Auto	Automatic		
		Manual	Manual		
		Event	Event		
Ack	Used in conjunction with the latching parameter. It is set when the user responds to an alarm.	No Yes	Not acknowledged Acknowledged		Oper
Block	Alarm Blocking is used to prevent alarms from activating during start-up. In some applications, the measurement at start-up is in an alarm condition until the system has come under control. Blocking causes the alarms to be ignored until the system is under control (in the safe state), after this any deviations trigger the alarm	No Yes	No blocking Blocking		Oper
Delay	This is a small delay between sensing the alarm condition and displaying it. If in the time between the two, the alarm goes safe, then no alarm is shown and the delay timer is reset. It can be used on systems that are prone to noise.	0:00.0 to 500 mm:ss.s hh:mm:ss hhh:mm		0:00.0	Oper

8.5.1 Example: To Configure Alarm 1

Change Access level to configuration.

In this example the high alarm will be detected when the measured value exceeds 100.00.

The current measured value is 27.79 as measured by the 'Input' parameter. This parameter will normally be wired to an internal source such as a thermocouple input. In this example the alarm will set when the measured value exceeds the threshold 100.0 and will clear when the input decreases 0.50 units below the threshold level (i.e. at 99.5 units).

The screenshot shows a software window titled "COM1.ID255-Mini8 - Parameter Explorer (Alarm.1)". It contains a table with the following data:

Name	Description	Address	Value
Type	Alarm Type	10240	AbsHi (1)
In	Alarm Input		27.79
Threshold	Threshold	10241	100.00
Out	Output	10249	Off (0)
Inhibit	Alarm Inhibit	10247	No (0)
Hysteresis	Alarm Hysteresis	10242	0.50
Latch	Latching Mode	10244	None (0)
Ack	Alarm Acknowledge	10250	No (0)
Block	Alarm Blocking Mode Enable	10246	No (0)
Delay	Display Delay	10248	0 ...

At the bottom of the window, a status bar indicates "Alarm.1 - 10 parameters (3 hidden)".

8.6 Digital Alarm Parameters

Four groups of eight **digital** alarms are available. The following table shows the parameters to set up and configure alarms.

Folder: DigAlarm		Sub-folders: 1 to 32			
Name	Parameter Description	Value		Default	Access Level
Type	Selects the type of alarm	None	Alarm not configured		Conf
		PosEdge	On rising edge		
		NegEdge	On falling edge		
		Edge	On change		
		High	High (1)		
		Low	Low (0)		
In	This is the parameter that will be monitored and checked according to the AlarmType to see if an alarm condition has occurred	0 to 1			Oper
Out	The output indicates whether the alarm is on or off depending on: the alarm condition, latching and acknowledge, inhibiting and blocking.	Off	Alarm output deactivated		R/O
		On	Alarm output activated		
Inhibit	Inhibit is an input to the Alarm function. It allows the alarm to be switched OFF. Typically the Inhibit is connected to a digital input or event so that during a phase of the process alarms do not activate. For Example, if the door to a furnace is opened the alarms may be inhibited until the door is closed again.	No Yes	Alarm not inhibited Inhibit function active		Oper
Latch	Determine the type of latching the alarm will use, if any. Auto latching allows acknowledgement while the alarm condition is still active, whereas manual latching needs the condition to revert back to safe before the alarm can be acknowledged. See also the description at the beginning of this chapter	None	No latching is used		Oper
		Auto	Automatic		
		Manual	Manual		
		Event	Event		
Ack	Used in conjunction with the latching parameter. It is set when the user responds to an alarm.	No Yes	Not acknowledged Acknowledged		Oper
Block	Alarm Blocking is used to prevent alarms from activating during start-up. In some applications, the measurement at start-up is in an alarm condition until the system has come under control. Blocking causes the alarms to be ignored until the system is under control (in the safe state), after this any deviations trigger the alarm	No Yes	No blocking Blocking		Oper
Delay	This is a small delay between sensing the alarm condition and displaying it. If in the time between the two, the alarm goes safe, then no alarm is shown and the delay timer is reset. It can be used on systems that are prone to noise.	0:00.0 to 500 mm:ss.s hh:mm:ss hhh:mm		0:00.0	Oper

8.6.1 Example: To Configure DigAlarm 1

Change Access level to configuration.

In this example the digital alarm will come on if Timer 1 expires.

Timer.1.Out is wired to the alarm input. The DigAlarm.1.Out will turn on if the timer expires.

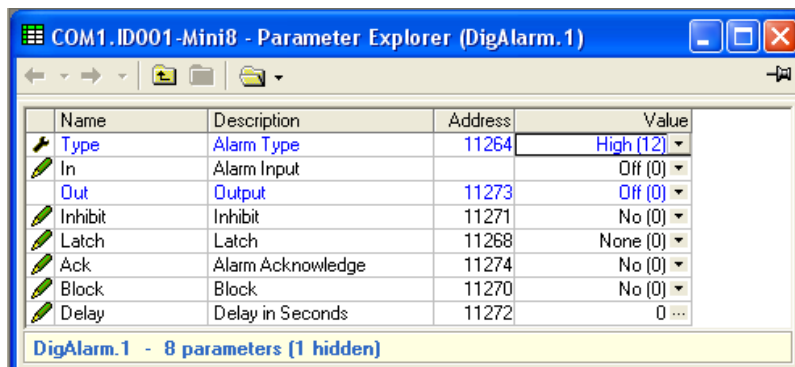

8.7 Alarm Summary

This is a summary of all the alarms in the Mini8 controller. It provides global alarm and acknowledge flags as well as 16 bit status words which can be read over communications by the supervisory system.

Folder: AlmSummary		Sub-folders: General			
Name	Parameter Description	Value		Default	Access Level
NewAlarm	A new alarm has occurred since the last reset (excludes CT alarms)	Off/On			R/O
RstNewAlarm	Resets the NewAlarm flag	Yes / No		No	Oper
NewCTAlarm	A new Current alarm has occurred since the last reset	Off/On			R/O
RstNewCTAlarm	Resets the NewCTAlarm flag	Yes / No		No	Oper
AnyAlarm	Any new alarm since the last reset	Off/On			R/O
GlobalAck	Acknowledges every alarm in the Mini8 controller requiring acknowledgement. Also resets NewAlarm and NewCTAlarm flags.	No Yes	Not acknowledged Acknowledged		Oper
AnAlarmStatus1	16 bit word for analogue alarms 1 to 8	Bit 0 Bit 1 Bit 2 Bit 3 Bit 4 Bit 5 Bit 6 Bit 7 Bit 8 Bit 9 Bit 10 Bit 11 Bit 12 Bit 13 Bit 14 Bit 15	Alarm 1 active Alarm 1 not ack'd Alarm 2 active Alarm 2 not ack'd Alarm 3 active Alarm 3 not ack'd Alarm 4 active Alarm 4 not ack'd Alarm 5 active Alarm 5 not ack'd Alarm 6 active Alarm 6 not ack'd Alarm 7 active Alarm 7 not ack'd Alarm 8 active Alarm 8 not ack'd		R/O
AnAlarmStatus2	16 bit word for analogue alarms 9 to 16	Same format as above			R/O
AnAlarmStatus3	16 bit word for analogue alarms 17 to 24	Same format as above			R/O
AnAlarmStatus4	16 bit word for analogue alarms 25 to 32	Same format as above			R/O
DigAlarmStatus1	16 bit word for digital alarms 1 to 8	Bit 0 Bit 1 Bit 2 Bit 3 Bit 4 Bit 5 Bit 6 Bit 7 Bit 8 Bit 9 Bit 10 Bit 11 Bit 12 Bit 13 Bit 14 Bit 15	Alarm 1 active Alarm 1 not ack'd Alarm 2 active Alarm 2 not ack'd Alarm 3 active Alarm 3 not ack'd Alarm 4 active Alarm 4 not ack'd Alarm 5 active Alarm 5 not ack'd Alarm 6 active Alarm 6 not ack'd Alarm 7 active Alarm 7 not ack'd Alarm 8 active Alarm 8 not ack'd		R/O
DigAlarmStatus2	16 bit word for digital alarms 9 to 16	Same format as above			R/O
DigAlarmStatus3	16 bit word for digital alarms 17 to 24	Same format as above			R/O
DigAlarmStatus4	16 bit word for digital alarms 25 to 32	Same format as above			R/O

Folder: AlmSummary		Sub-folders: General			
Name	Parameter Description	Value		Default	Access Level
SBrkAlarmStatus1	16 bit word for IO channels Mod.1 to 8	Bit 0	Mod.1 fault		R/O
		Bit 1	Alarm 1 not ack'd		
		Bit 2	Mod.2 fault		
		Bit 3	Alarm 2 not ack'd		
		Bit 4	Mod.3 fault		
		Bit 5	Alarm 3 not ack'd		
		Bit 6	Mod.4 fault		
		Bit 7	Alarm 4 not ack'd		
		Bit 8	Mod.5 fault		
		Bit 9	Alarm 5 not ack'd		
		Bit 10	Mod.6 fault		
		Bit 11	Alarm 6 not ack'd		
		Bit 12	Mod.7 fault		
		Bit 13	Alarm 7 not ack'd		
		Bit 14	Mod.8 fault		
		Bit 15	Alarm 8 not ack'd		
SbrkAlarmStatus2	16 bit word for IO channels Mod.9 to 16	Same format as above			R/O
SbrkAlarmStatus3	16 bit word for IO channels Mod.17 to 24	Same format as above			R/O
SbrkAlarmStatus4	16 bit word for IO channels Mod.25 to 32	Same format as above			R/O
CTAlarmStatus1	16 bit word for CT alarms 1 to 5	Bit 0	Load1 SSR fail		R/O
		Bit 1	Load1 PLF		
		Bit 2	Load1 OCF		
		Bit 3	Load2 SSR fail		
		Bit 4	Load2 PLF		
		Bit 5	Load2 OCF		
		Bit 6	Load3 SSR fail		
		Bit 7	Load3 PLF		
		Bit 8	Load3 OCF		
		Bit 9	Load4 SSR fail		
		Bit 10	Load4 PLF		
		Bit 11	Load4 OCF		
		Bit 12	Load5 SSR fail		
		Bit 13	Load5 PLF		
		Bit 14	Load5 OCF		
		Bit 15	-		
CTAlarmStatus2	16 bit word for CT alarms 6 to 10	Bit 0	Load6 SSR fail		R/O
		Bit 1	Load6 PLF		
		Bit 2	Load6 OCF		
		Bit 3	Load7 SSR fail		
		Bit 4	Load7 PLF		
		Bit 5	Load7 OCF		
		Bit 6	Load8 SSR fail		
		Bit 7	Load8 PLF		
		Bit 8	Load8 OCF		
		Bit 9	Load9 SSR fail		
		Bit 10	Load9 PLF		
		Bit 11	Load9 OCF		
		Bit 12	Load10 SSR fail		
		Bit 13	Load10 PLF		
		Bit 14	Load10 OCF		
		Bit 15	-		
CTAlarmStatus3	16 bit word for CT alarms 11 to 15	Same format as CTAlarmStatus1			R/O
CTAlarmStatus4	16 bit word for CT alarm 16	Same format as CTAlarmStatus1			R/O

8.8 Alarm Log

A list of the last 32 alarms to have occurred is maintained in an Alarm Log.

Folder: AlmSummary		Sub-folder: AlmLog		
Name	Parameter Description	Value	Default	Access Level
ClearLog	Clear Alarm Log	Yes/No	No	Oper
Entry1Ident	Most recent alarm activation	All analogue alarms All digital alarms All sensor break alarms All current alarms	NoEntry	R/O
Entry1Day	The day the first entry activated	NoEntry, Monday/Tuesday...Sunday.	NoEntry	R/O
Entry1Time	The time the first entry activated	hh:mm:ss	0	R/O
Entry2Ident	2 nd most recent alarm activation	All analogue alarms All digital alarms All sensor break alarms All current alarms	NoEntry	R/O
Entry2Day	The day the second entry activated	NoEntry, Monday/Tuesday...Sunday.	NoEntry	R/O
Entry2Time	The time the second entry activated	hh:mm:ss	0	R/O
...etc				
Entry32Ident	32 nd most recent alarm activation	All analogue alarms All digital alarms All sensor break alarms All current alarms	NoEntry	R/O
Entry32Day	The day the 32 nd entry activated	NoEntry, Monday/Tuesday...Sunday.	NoEntry	R/O
Entry32Time	The time the 32 nd entry activated	hh:mm:ss	0	R/O

Note that EntryDay and EntryTime parameters require the Real Time Clock to be set up (Section 11.4) to record meaningful values.

9. Chapter 9 BCD Input

The Binary Coded Decimal (BCD) input function block uses a number of digital inputs and combines them to make a numeric value. A very common use for this feature is to select a setpoint program number from panel mounted BCD decade switches.

The block uses 4 bits to generate a single digit.

Two groups of four bits are used to generate a two digit value (0 to 99)

The block outputs four results

1. Units Value: The BCD value taken from the first four bits (range 0 - 9)
2. Tens Value: The BCD value taken from the second four bits (range 0 - 9)
3. BCD Value: The combined BCD value taken from all 8 bits (range 0 - 99)
4. Decimal Value: The decimal numeric equivalent of Hexadecimal bits (range 0 - 255)

The following table shows how the input bits combine to make the output values.

Input 1	Units value (0 - 9)	BCD value (0 - 99)	Decimal value (0 - 255)
Input 2			
Input 3			
Input 4			
Input 5	Tens value (0 - 9)		
Input 6			
Input 7			
Input 8			

Since the inputs cannot all be guaranteed to change simultaneously, the output will only update after all the inputs have been stable for two samples.

9.1 BCD Parameters

Folder - BCDInput		Sub-Folders: 1 and 2			
Name	Parameter Description	Value		Default	Access Level
In 1	Digital Input 1	On or Off	Alterable from the operator interface if not wired	Off	Oper
In 2	Digital Input 2	On or Off		Off	Oper
In 3	Digital Input 3	On or Off		Off	Oper
In 4	Digital Input 4	On or Off		Off	Oper
In 5	Digital Input 5	On or Off		Off	Oper
In 6	Digital Input 6	On or Off		Off	Oper
In 7	Digital Input 7	On or Off		Off	Oper
In 8	Digital Input 8	On or Off		Off	Oper
Dec Value	Decimal value of the inputs	0 - 255	See examples below		R/O
BCD Value	Reads the value (in BCD) of the switch as it appears on the digital inputs	0 - 99	See examples below		
Units	Units value of the first switch	0 - 9	See examples below		R/O
Tens	Units value of the second switch	0 - 9	See examples below		R/O

In 1	In 2	In 3	In 4	In 5	In 6	In 7	In 8	Dec	BCD	Units	Tens
1	0	0	0	0	0	0	0	1	1	1	0
1	1	1	1	0	0	0	0	15	9	9	0
0	0	0	0	1	1	1	1	240	90	0	9
1	1	1	1	1	1	1	1	255	99	9	9

9.1.1 Example: To wire a BCD Input

The BCD digital input parameters may be wired to digital input terminals of the controller. A DI8 module may be used and there are also two standard digital input terminals in FixedIO, D1 and D2.

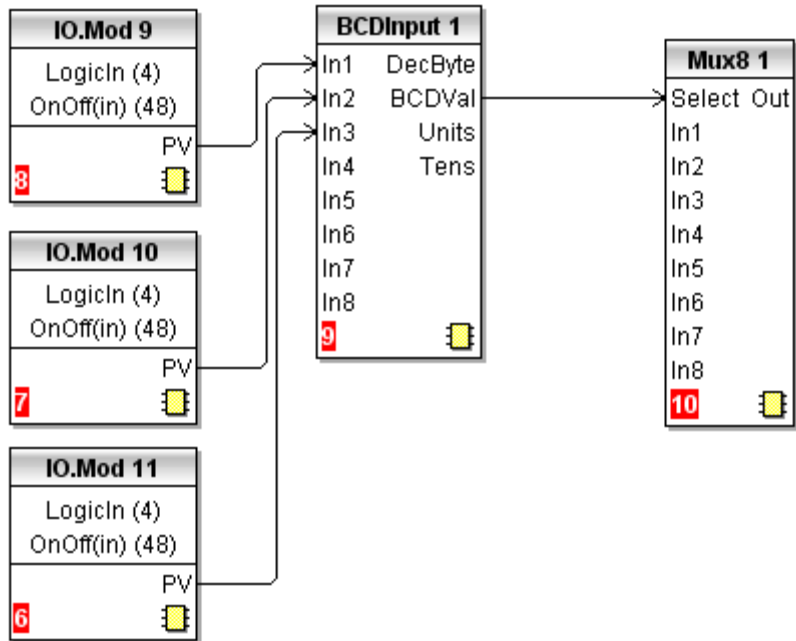

This example shows a BCD switch selecting one of eight values, In1 to In8 on the Mux8.

10. Chapter 10 Digital Communications

Digital Communications (or 'comms' for short) allows the Mini8 controller to be part of a system by communicating with a PC or a programmable logic controller (PLC).

The Mini8 controller also has a configuration port for 'cloning' or saving/loading instrument configurations for future expansion of the plant or to allow you to recover a system after a fault.

10.1 Configuration Port (CC)

The configuration port is on an RJ11 socket, just to the right of the power supply connections. This will normally be connected to a personal computer running iTools. Eurotherm supply a standard cable to connect a serial COM port on a computer to the RJ11 socket, part no. **SubMini8/cable/config**.

This port conforms to MODBUS RTU ® protocol a full description of which can be found on www.modbus.org.

Pin connections for the RJ11 connector are shown in section 1.4.4

10.1.1 Configuration Communications Parameters

Folder - Comms		Sub-folders: CC (Config Comms)			
Name	Parameter Description	Value		Default	Access Level
Ident	Identification of the module fitted.	Modbus always.		Modbus non-iso	R/O
Protocol	Digital communications protocol	Modbus always		MODBUS	R/O
Baud	Communications baud rate	4800 9600 19k2 (19200)		19200	Conf
Parity	Communications parity	None Even Odd	No parity Even parity Odd parity	None	Conf
Address	Instrument address	1 to 254		1	Oper
Wait	Rx/tx wait states	No Yes	No delay Fixed delay. This inserts a delay between Rx and Tx to ensure that the drivers used by intelligent RS232/RS485 converters have sufficient time to switch over.	No	Conf

When connecting to iTools the instrument on this port will be found at address 255. iTools will also optimise the baud rate to suit the conditions.

This port can be used as a 'permanent' connection but it is limited to one instrument, it is a RS232 point to point connection.

Configuration is also possible through the Field Communications port but ONLY if that port is Modbus or ModbusTCP. In that situation the Mini8 controllers can be multi-dropped to iTools.

10.2 Field Communications Port (FC)

The Mini8 controller has a number of communication options. These have to be ordered from the factory as part of the instrument build. A change of protocol is not usually possible in the field. The physical port and the connections will vary depending on the field communications protocol. These are shown in the wiring section of the manual section 1.4. Mini8 controller version 1.xx offers Modbus and DeviceNet, Version 2.xx adds CANopen, Profibus, EtherNet Modbus-TCP and EtherNet/IP. These protocols are described in the following sections.

10.2.1 Communications Identity

The instrument recognizes the type of communication board fitted. The identity '**Ident**' is displayed to show that the instrument is built as required.

10.3 Modbus

This port conforms to MODBUS RTU ® protocol a full description of which can be found on www.modbus.org.

10.3.1 Modbus Connections

This uses two parallel RJ45 connectors for use with screened Cat5e patch cables. The connection is usually 2 wire but 4 wire is also available. This is selected by the top switch of the address switches below the RJ45 ports - OFF (to the left) 2 wire, ON (to the right) 4 wire.

RJ45 pin connections are shown in section 1.4.6

10.3.2 Modbus Address Switch

On a network of instruments an address is used to specify a particular instrument. Each instrument on a network MUST have a unique address. Address 255 is reserved for configuration using the configuration port or the configuration clip. The switch is situated at the bottom of the Comms module. The switch gives addresses from 1 to 31. If Address 0 is set the Mini8 controller will then take the address and parity settings entered in the configuration of the instrument, see section 10.4.2. This allows for addresses above 31.

Sw	OFF	ON
8	3 wire	4 wire
7	NO Parity	Parity
6	Even	Odd
5	-	Address 16
4	-	Address 8
3	-	Address 4
2	-	Address 2
1	-	Address 1

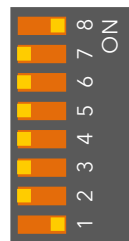

OFF ↔ ON

Example shows 4 wire and address 1

10.3.3 Baud Rate

The baud rate of a communications network specifies the speed that data is transferred between instrument and master. A baud rate of 9600 equates to 9600 Bits per second. Since a single character requires 8 bits of data plus start, stop, and optional parity, up to 11 bits per byte may be transmitted. 9600 baud equates approximately to 1000 Bytes per second. 4800 baud is half the speed - approx. 500 Bytes per second.

In calculating the speed of communications in your system it is often the Latency between a message being sent and a reply being started that dominates the speed of the network.

For example, if a message consists of 10 characters (10msec at 9600 Baud) and the reply consists of 10 characters, then the transmission time would be 20 msec. However, if the Latency is 20msec, then the transmission time has become 40msec.

Baud rate is set in the parameter list see section 10.4.2.

10.3.4 Parity

Parity is a method of ensuring that the data transferred between devices has not been corrupted.

Parity is the lowest form of integrity in the message. It ensures that a single byte contains either an even or an odd number of ones or zero in the data.

In industrial protocols, there are usually layers of checking to ensure that the first byte transmitted is good. Modbus applies a CRC (Cyclic Redundancy Check) to the data to ensure that the package is correct.

Parity is set in the parameter list see section 10.4.2.

10.3.5 RX/TX Delay Time

In some systems it is necessary to introduce a delay between the instrument receiving a message and its reply. This is sometimes caused by communications converter boxes which require a period of silence on the transmission to switch over the direction of their drivers.

10.4 Modbus Broadcast Master Communications

Broadcast master communications allow the Mini8 controllers to send a single value to any slave instruments using a Modbus broadcast using function code 6 (Write single value). This allows the Mini8 controller to link through digital communications with other products without the need for a supervisory PC to create a small system solution.

Example applications include multi-zone profiling applications or cascade control using a second controller. The facility provides a simple and precise alternative to analogue retransmission.



Warning

When using broadcast master communications, be aware that updated values are sent many times a second. Before using this facility, check that the instrument to which you wish to send values can accept continuous writes. *Note that in common with many third party lower cost units, the Eurotherm 2200 series and the 3200 series prior to version V1.10 do not accept continuous writes to the temperature setpoint. Damage to the internal non-volatile memory could result from the use of this function. If in any doubt, contact the manufacturer of the device in question for advice.*

When using the 3200 series fitted software version 1.10 and greater, use the Remote Setpoint variable at Modbus address 26 if you need to write to a temperature setpoint. This has no write restrictions and may also have a local trim value applied. There is no restriction on writing to the 2400, 3500 or Mini8 controller series.

10.4.1 Mini8 Controller Broadcast Master

The Mini8 controller broadcast master can be connected to up to 31 slaves if no segment repeaters are used. If repeaters are used to provide additional segments, 32 slaves are permitted in each new segment. The master is configured by selecting a Modbus register address to which a value is to be sent. The value to send is selected by wiring it to the Broadcast Value. Once the function has been enabled, the instrument will send this value out over the communications link every control cycle typically every 110ms.

Notes:-

1. The parameter being broadcast must be set to the same decimal point resolution in both master and slave instruments.
2. If iTools, or any other Modbus master, is connected to the port on which the broadcast master is enabled, then the broadcast is temporarily inhibited. It will restart approximately 30 seconds after iTools is removed. This is to allow reconfiguration of the instrument using iTools even when broadcast master communications is operating.

A typical example might be a multi zone application where the setpoint of each zone is required to follow, with digital accuracy, the setpoint of a master.

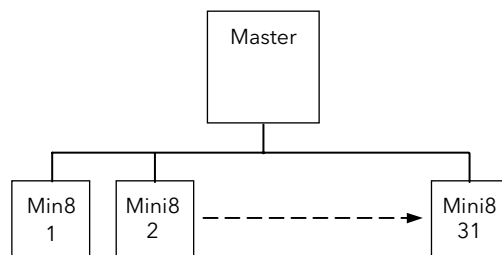

Figure 10-1: Broadcast Comms

Wiring Connections for Broadcast Communications are shown in section 1.4.6.3.

10.4.2 Modbus Parameters

The following table shows the parameters available for Modbus.

Folder - Comms		Sub-folder: FC (Field Communications)			
Name	Parameter Description	Value		Default	Access Level
Ident	Comms Module Identity	Modbus		Modbus	Read only
Protocol	Digital communications protocol	Modbus		Modbus	Read only
Baud	Communications baud rate	Modbus: 4800, 9600 or 19k2 (19200)		9600	Conf
Parity	Communications parity	None Even Odd	No parity Even parity Odd parity	None	Conf
Address	Instrument address	1 to 254 Only writable if DIP switches are set to Off.		1	Oper
Wait	Rx/tx delay time	No Yes	No delay Fixed delay. This inserts a delay between Rx and Tx to ensure that the drivers used by intelligent RS232/RS485 converters have sufficient time to switch over.	No	Conf
Broadcast Enabled	To enable broadcast master communications. (See section 10.4)	No Yes	Not enabled Enabled	No	
Broadcast Address	Address of the parameter being written to slaves.	0 to 32767	See Appendix A for addresses of all Mini8 controller parameters.	0	Only shown if Broadcast is enabled.
Broadcast Value	Value to be sent to instruments on the network. This would normally be wired to a parameter within the master.	Range of the parameter wired. In the case of a Boolean the value will be 0 or 1.		0.00	Only shown if Broadcast is enabled.
WDFlag	Network watchdog flag	Off On	This flag is ON when the Network communications have stopped addressing this instrument for longer than the Timeout time. It will be set by the Watchdog process and may be cleared Automatically or Manually according to the value of the Watchdog Action parameter.		
WDAct	Network watchdog action. The Watchdog Flag may be cleared Automatically upon reception of valid messages or Manually by a parameter write or a wired value.	Man Auto	The Watchdog Flag must be cleared manually - either by a parameter write or a wired value. The Watchdog Flag will be automatically cleared when the Network Comms resume - according to the value in the Recovery Timer.		Conf
WDTime	Network Watchdog Timeout If the Network communications stop addressing the instrument for longer than this value, the Watchdog Flag will become active.	h:m:s:ms A value of 0 disables the watchdog			Conf

10.5 DeviceNet

Only 2 parameters have to be set on the Mini8 controller for use with DeviceNet, baud rate and address. Both can be set on the hardware address switch situated under the DeviceNet connector. Each Mini8 controller must have a unique address on the DeviceNet network and all units must be set to the same Baud rate. The switch gives addresses from 0 to 63.

Sw	OFF	ON
8	Baud rate	Baud rate
	Baud rate	Baud rate
6	-	Address 32
5	-	Address 16
4	-	Address 8
3	-	Address 4
2	-	Address 2
1	-	Address 1

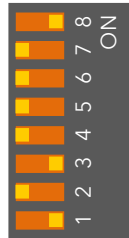

Example shows 500k baud rate and address 5

OFF ↔ ON

Address 0 is a valid DeviceNet address but Mini8 Controller addresses can be set via iTools, when all switches are set to 0.

Sw	Baud rate		
	125k	250k	500k
8	OFF	OFF	ON
7	OFF	ON	OFF

Use 500k unless the total length of the DeviceNet network is longer than 100m.

10.6 Enhanced DeviceNet Interface

See also section 1.4.8. In this version of DeviceNet the slider switch is replaced by rotary BCD switches to set Node ID (address) and Baud Rate.

10.6.1 Address Switch

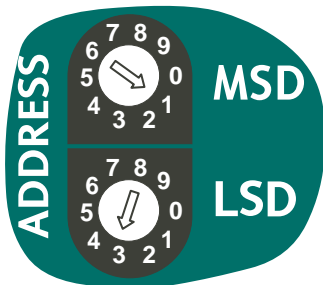

The Node ID (address) is set via two BCD rotary switches, one for each digit. For example, an address of 13 is configured by setting the MSD to 1 and LSD to 3.

Valid DeviceNet address range is 0 - 63. If the switches are set in the range 64 - 99 the value will be ignored and the node address will be configured by the Mini8 Controller via iTools.

When the address is changed the DeviceNet interface will automatically restart.

10.6.2 Baud Switch

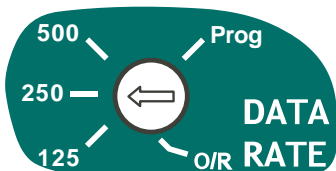

The baud rate is selected by a single BCD rotary switch, and can be set to 125K, 250K or 500K.

The 'Prog' position is selected when it is required to upgrade the Mini8 Controller firmware.

The O/R position is selected when it is required to set Baud Rate using iTools configuration software.

When the baud rate is changed or the 'Prog' position is selected the instrument must be power cycled for the change to be activated.

Make sure that the switch is set to valid positions as marked on the panel.

10.7 Switch Position in iTools

The value of the Baud Rate and Address is returned so that it can be read by iTools.

Please note, however, that if the DeviceNet network is unpowered for any reason, any changes to the Baud Rate and Address will NOT be seen in iTools even though the Mini8 Controller is powered and communicating normally via the CC port or config clip.

10.7.1 DeviceNet Parameters

Folder - Comms		Sub-folder: FC (Field Communications)			
Name	Parameter Description	Value	Default	Access Level	
Ident	Comms Module Identity	DeviceNet DeviceNet Enhanced	DeviceNet	Read only	
Protocol	Digital communications protocol	DeviceNet	DeviceNet	Read only	
Baud	Communications baud rate	125k, 250k, 500k	125k	Conf	
Address	Instrument address	0 to 63 Only writable if DIP switches are set to Off.	1	Oper	
Status	Comms network status	Offline	Network Offline		Read only
		Init	Network Initialising		
		Ready	Network ready to accept connection		
		Running	Network connected and running		
		Online	The device is on line and has connections in the Established state.		
		IO Timeout	One or more IO connections have timed out.		
		Link fail	Critical link failure: an error has been detected that has made the module incapable of communicating.		
		Comm fault	Comms port is in the faulted condition and has accepted an Identify Comms Fault Request		
WDFlag	Network watchdog flag	Off	This flag is ON when the Network communications have stopped addressing this instrument for longer than the Timeout time. It will be set by the Watchdog process and may be cleared Automatically or Manually according to the value of the Watchdog Action parameter.		
		On			
WDAct	Network watchdog action. The Watchdog Flag may be cleared Automatically upon reception of valid messages or Manually by a parameter write or a wired value.	Man	The Watchdog Flag must be cleared manually - either by a parameter write or a wired value.		Conf
		Auto	The Watchdog Flag will be automatically cleared when the Network Comms resume - according to the value in the Recovery Timer.		
WDTime	Network Watchdog Timeout If the Network communications stop addressing the instrument for longer than this value, the Watchdog Flag will become active.	h:m:s:ms A value of 0 disables the watchdog			Conf

10.8 CANopen

Note: from July 09 CANopen option has been discontinued. It is included here for existing systems.

10.8.1 Instrument setup

Up to 127 Nodes can be connected to a standard CANopen Network, for nodes 1 - 31 the address can be set via the comms DIP switches. For nodes 32 - 127 the address switches must be set to OFF making the Address parameter alterable in the Config Comms List, which then can be used to set the Node address.

Sw	OFF	ON
8	Baud rate	Baud rate
7	Baud rate	Baud rate
6	-	Address 32
5	-	Address 16
4	-	Address 8
3	-	Address 4
2	-	Address 2
1	-	Address 1



Example shows 1M baud rate and address 4

OFF ↔ ON

Sw	Baud rate			
	125k	250k	500k	1M
8	OFF	OFF	ON	ON
7	OFF	ON	OFF	ON

A standard CANopen Network is designed to work at data transfer rates of up to 1Mbits/s (depending upon bus length). Four baud rate settings are set on the comms DIP switches: 125K, 250K, 500K and 1M.

10.8.2 Mini8 Controller CANopen Features

The main features of the Mini8 controller CANopen Slave Interface are:

- CANopen-to-Modbus Gateway
- Generic Device
- 4 Receive PDOs (dynamic)
- 4 Transmit PDOs (dynamic)
- PDO communication and mapping object values can be stored in non-volatile memory
- 1 Server SDO
- 200 Parameter Pick List (re-definable)
- PDO Mappings cloneable via CommsTab function block

CANopen is a higher layer object based CAN network protocol that supports direct access to device parameters, transmission of time critical process data and network management diagnostics via a standardised object dictionary.

The generic CANopen model shows that the device (Node) is connected to a CAN network on one side and application specific I/O data on the other.

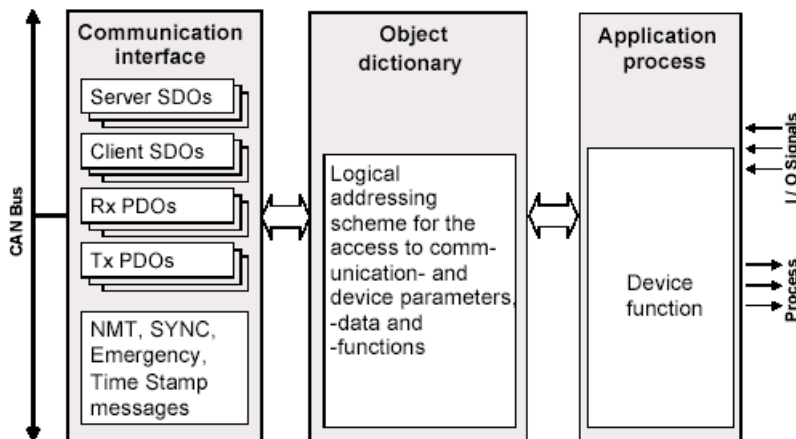

10.8.3 Communication Interface

CANopen is based on communication profiles, which specifies the basic communication mechanisms (PDOs, SDOs and NMT messages) and an object directory that specifies device parameters and functions.

10.8.3.1 Object Dictionary

The object dictionary is divided into a section containing general device information (device identification, manufacturer name etc), communication parameters, and a section that describes the specific device data/functionality whether by a device profile (part of CANopen specifications) or manufacturer specified.

Index	Description	Range
0000h	Reserved	Data Types
0001h - 025Fh	Data Type Definitions	
0260h - 0FFFh	Reserved	
1000h - 1FFFh	General communication parameters	Communication Profile
1200h - 127Fh	Communication parameters for server SDOs	
1280h - 12FFh	Communication parameters for client SDOs	
1300h - 13FFh	Reserved	
1400h - 15FFh	Communication parameters for receive PDOs	
1600h - 17FFh	Mapping parameter for receive PDOs	
1800h - 19FFh	Communication parameters for transmit PDOs	
1A00h - 1BFFh	Mapping parameter for transmit PDOs	
1C00h - 1FFFh	Reserved for extensions (i.e. DSP-302)	
2000h - 5FFFh	Manufacturer Specific Profile objects	
6000h - 9FFFh	Standardised Device Profiles	
A000h - BFFFh	Interface profile specific objects	Interface Profile
C000h - FFFFh	Reserved	

10.8.3.2 Process Data Objects (PDOs)

The transfer of process data between devices on a network is the main purpose of a CAN-based communication system. In CANopen, this is performed by PDOs, which map process data from an application object(s) (similar to DeviceNet Class 0x64) into communication objects (similar to DeviceNet Class 0x66).

PDOs are separated into two groups, Transmit PDOs and Receive PDOs. Each PDO message is capable of containing 8 bytes of data (four 16-bit scaled integer parameters). Transmit PDOs are typically used to transmit critical instrument data to other nodes on the network, for example, alarm status'. Receive PDOs are typically used to configure instrument settings, for example, TargetSP.

For the Mini8 controller the number of PDOs is limited to 4 transmit PDOs and 4 receive PDOs, giving a maximum of 16 transmit and 16 receive scaled integer parameters.

Note Transmit PDO = transmitted from the Mini8 (READ), Receive PDO = received by Mini8 (WRITE).

10.8.3.3 Service Data Objects (SDOs)

To access entries in the Object dictionary CANopen uses SDOs, peer to peer communication channels (similar to explicit messaging in DeviceNet), generally used during system configuration or to request non-critical process data.

This gives access to Network Management, Device & Manufacturer Information, Error Messages, Reconfiguration and control of PDOs, Store & restore of configuration, Heartbeat & Node Guarding,

10.8.4 Network Management (NMT)

CANopen slave nodes include the following state machine, which allows the slaves to be in different operating states.

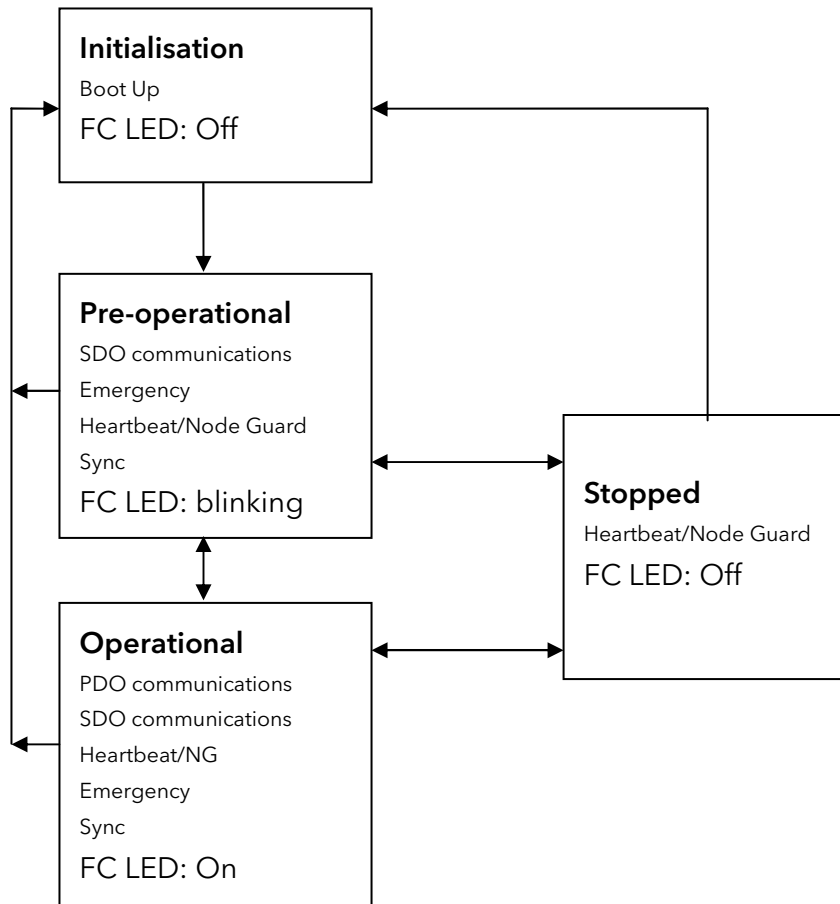

Transitions between some states are made automatically by the slaves themselves, whereas others can only be made upon receiving the corresponding NMT Master message.

Upon power-up the slave node comes out of the Power-On Reset state and goes into initialisation. It then initialises the application and communication interface. It then attempts to transmit a boot-up message. When the boot-up message has been successfully transmitted the node enters the Pre-Operational state where it is possible for the network master to configure individual nodes via SDO messages. The master can then switch individual nodes or all nodes to the Operational state (allowing PDO communications i.e. the running state) or the Stopped state.

10.8.4.1 Heartbeat & Node Guarding

The Mini8 controller interface supports both Node Guarding and the Heartbeat Protocol. With Node Guarding it is the responsibility of a Master device to guard (poll) all connected slaves for their current NMT state. With the Heartbeat method, each slave device transmits a heartbeat (a 1-byte message containing the current NMT state) periodically. The Heartbeat protocol is the most widely used.

10.8.4.2 Emergencies (EMCY)

Each CANopen slave device is assigned an emergency message. If the slave device has recognised that a fault/error exists it transmits an emergency message to inform the network of the problem.

10.8.5 Device Profile DS-404

DS-404 is the Device Profile for Measuring Devices and Closed Loop Controllers. It specifies in which object each Input, Output, Alarm and Control parameters for each channel should reside. DS-404 is not considered appropriate for the Mini8 controller due to its inherent modular and versatile architecture which allows different alarms, IO etc to be associated with different channels.

The Mini8 controller is classed as a Generic Device as its CANopen application objects have been specified by Eurotherm using the range from 2000h.

10.8.6 Default PDOs

Transmit PDOs are typically used to transmit critical instrument data to other nodes on the network, for example, alarm status'. Receive PDOs are typically used to configure instrument settings, for example, TargetSP.

The Mini8 controller PDOs are preconfigured with a standard set of parameters. PDO blocks may be Enabled or Disabled via SDO communications. In the Mini8 controller the transmit PDOs can also be set to transmit cyclically, or on change of state, or both.

The parameters in the PDO blocks may be replaced by other ones if required. There are 2 methods to achieve this:

- using Commstab blocks to redirect the CANopen object to a different Modbus parameter. This has the advantage that an instrument clone will behave in the same way as the original.
- using CANopen communications to reconfigure the PDO block.

Both of these methods will be described.

10.8.6.1 Letter Boxing

The number of PDOs is limited to 4 transmit PDOs and 4 receive PDOs, giving a maximum of 16 transmit and 16 receive scaled integer parameters. This is very restrictive for the Mini8 controller, which has up to 16 loops, therefore, some loop parameters are 'letter boxed' whereby the user can specify to which loop the data is intended.

For example in Transmit PD03 if the parameter 'Loop Number' has the value 0 then the PV, TargetSP and ActiveOut are all from Loop 1. This will cycle around all enabled loops at a rate set in the Mini8 controller parameter Comms.FC.TxPDO3InstTime. If this time is zero then the CANopen master may write a value to the Loop Number parameter to get whichever Loop PV, TargetSP and ActiveOut it requires.

10.8.6.2 Transmit PDO1

This contains the Analogue Alarm Status words. As default it is Enabled and configured to transmit when any of the status word values change.

Object Index	Sub Index	Parameter	Data Type
1A00h	00h	Number of Supported Entries [4]	Unsigned8
	01h	AlmSummary.AnAlarmStatus1	Integer16
	02h	AlmSummary.AnAlarmStatus2	Integer16
	03h	AlmSummary.AnAlarmStatus3	Integer16
	04h	AlmSummary.AnAlarmStatus4	Integer16

10.8.6.3 Transmit PDO2

This contains the Sensor Break Alarm Status words. As default it is Enabled and configured to transmit when any of the status word values change.

Object Index	Sub Index	Parameter	Data Type
1A01h	00h	Number of Supported Entries [4]	Unsigned8
	01h	AlmSummary.SBrkAlarmStatus1	Integer16
	02h	AlmSummary.SBrkAlarmStatus2	Integer16
	03h	AlmSummary.SBrkAlarmStatus3	Integer16
	04h	AlmSummary.SBrkAlarmStatus4	Integer16

10.8.6.4 Transmit PDO3

This contains Loop.n operational data. As default it is Enabled and configured to transmit cyclically. The Loop Number will be cycled round the enabled loops with the time between each change in the loop number being set by Comms.FC.TxPDO3InstTime. If this time is set to '0' then the loop number will not be cycled, instead the user sets the loop number via SDO communications.

Object Index	Sub Index	Parameter	Data Type
1A02h	00h	Number of Supported Entries [4]	Unsigned8
	01h	Loop Number [0....15 corresponding to n=1....16]	Integer16
	02h	Loop.n.Main.PV	Integer16
	03h	Loop.n.Main.WorkingSP	Integer16
	04h	Loop.n.Main.ActiveOut	Integer16

10.8.6.5 Transmit PDO4

This contains Programmer.n operational data. As default it is Enabled and configured to transmit cyclically. The Programmer Number will be cycled round the enabled programmers with the time between each change in programmer number being set by Comms.FC.TxPDO4InstTime. If this time is set to '0' then the programmer number will not be cycled, instead the user sets the programmer number via SDO communications.

Object Index	Sub Index	Parameter	Data Type
1A03h	00h	Number of Supported Entries [4]	Unsigned8
	01h	Programmer Number [0....7 corresponding to n=1....8]	Integer16
	02h	Programmer.n.Run.CurProg	Integer16
	03h	Programmer.n.Run.ProgStatus	Integer16
	04h	Programmer.n.Run.ProgTimeLeft	Integer16

10.8.6.6 Receive PDO1

This contains control loop Operational parameters, the loop number must be specified in order for the Mini8 controller to set the correct loop instance parameters.

Object Index	Sub Index	Parameter	Data Type
1600h	00h	Number of Supported Entries [4]	Unsigned8
	01h	Loop Number [0....15 corresponding to n=1....16]	Integer16
	02h	Loop.n.Main.TargetSP	Integer16
	03h	Loop.n.Main.AutoMan	Integer16
	04h	Loop.n.OP.ManualOutVal	Integer16

10.8.6.7 Receive PDO2

This contains control loop PID parameters, the loop number must be specified in order for the Mini8 controller to set the correct loop instance parameters.

Object Index	Sub Index	Parameter	Data Type
1601h	00h	Number of Supported Entries [4]	Unsigned8
	01h	Loop Number [0....15 corresponding to n=1....16]	Integer16
	02h	Loop.n.PID.ProportionalBand	Integer16
	03h	Loop.n.PID.IntegralTime	Integer16
	04h	Loop.n.PID.DerivativeTime	Integer16

10.8.6.8 Receive PDO3

This will contain control loop SP parameters, the loop number must be specified in order for the Mini8 controller to set the correct loop instance parameters.

Object Index	Sub Index	Parameter	Data Type
1602h	00h	Number of Supported Entries [4]	Unsigned8
	01h	Loop Number [0....15 corresponding to n=1....16]	Integer16
	02h	Loop.n.SP.SP1	Integer16
	03h	Loop.n.SP.SP2	Integer16
	04h	Loop.n.SP.SPSelect	Integer16

10.8.6.9 Receive PDO4

This contains Programmer Operational parameters, the programmer number must be specified in order for the Mini8 controller to set the correct programmer instance parameters.

Object Index	Sub Index	Parameter	Data Type
1603h	00h	Number of Supported Entries [4]	Unsigned8
	01h	Programmer Number [0....7 corresponding to n=1....8]	Integer16
	02h	Programmer.n.SetUp.ProgRun	Integer16
	03h	Programmer.n.SetUp.ProgHold	Integer16
	04h	Programmer.n.SetUp.ProgReset	Integer16

10.8.7 Enabling and Disabling PDO Communications

The Mini8 controller is supplied with all 8 PDOs enabled.

Every PDO has a mapping object and a communication object as shown. The PDO is enabled by resetting the appropriate bit and disabled by setting the appropriate bit. This is done using SDO communications.

PDO	Mapping Object	Communication Object	PDO Enable Object Sub-index / bit
Receive PDO1	1600h	1400h	1400h 1h /31
Receive PDO2	1601h	1401h	1401h 1h /31
Receive PDO3	1602h	1402h	1402h 1h /31
Receive PDO4	1603h	1403h	1403h 1h /31
Transmit PDO1	1A00h	1800h	1800h 1h /31
Transmit PDO2	1A01h	1801h	1801h 1h /31
Transmit PDO3	1A02h	1802h	1802h 1h /31
Transmit PDO4	1A03h	1803h	1803h 1h /31

10.8.8 Changing PDO Mapping

If the parameters included as default above are not those required they may be replaced by others. The recommended way to do this is to redirect using the Commstab tables.

The Manufacturer Object Pick List is in Appendix C. The first 32 items map directly onto the default PDOs which use Modbus addresses 15816 to 15847. The Commstab tables can map any instrument parameter onto these addresses.

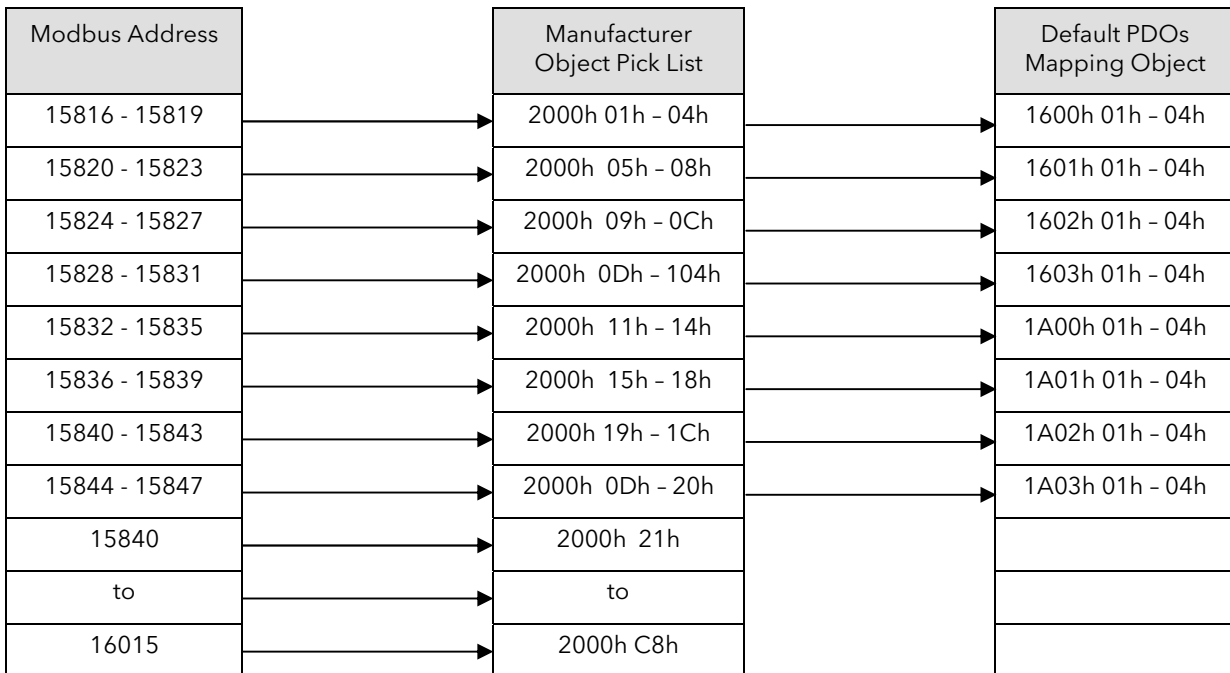

10.8.8.1 Commstab Example 1

Remap Receive PDO 1 with UsrVal.1-4.Vals:

Receive PDO1 from the Object pick list in Appendix C is shown below

Object Index	Sub Index	Parameter	Data Type	SCADA Address
2000h	<i>Receive PDO1 Note: Sub indices 02h - 04h are letter boxed via sub index 01h.</i>			
	01h	Loop Number (Comms.InstNum1)	Integer16	15816
	02h	Loop.n.Main.TargetSP	Integer16	15817
	03h	Loop.n.Main.AutoMan	Integer16	15818
	04h	Loop.n.OP.ManualOutVal	Integer16	15819

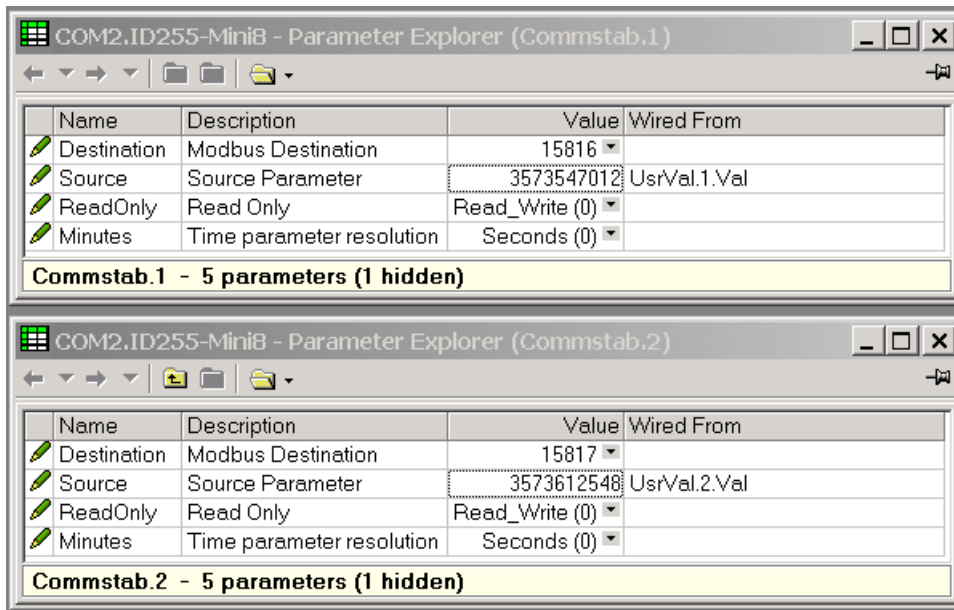

Similarly with Commstab 3 and 4 which will give a final Receive PDO 1 as shown in the diagram below. Note there is now no letterbox parameter as the indexing parameter has been replaced.

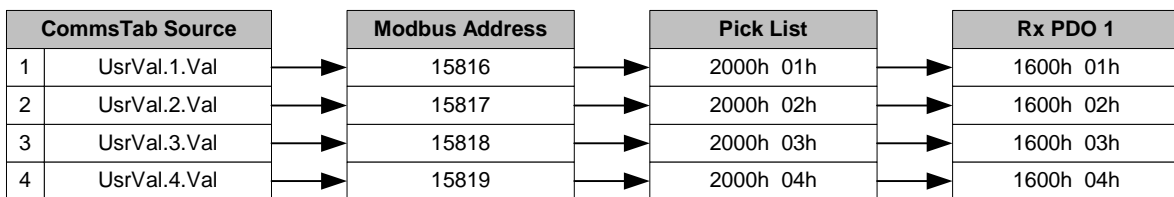

10.8.8.2 Commstab Example 2

Remap Transmit PDO 3 sub index 04h with Loop.Main.AutoMan, using letter boxing for the loop instance.

Receive PDO3 from the Object pick list in Appendix C is shown below.

Object Index	Sub Index	Parameter	Data Type	SCADA Address
2000h	<i>Transmit PDO3 Note: Sub indices 1Ah - 1Ch are letter boxed via sub index 19h.</i>			
	19h	Loop Number (Comms.InstNum5)	Integer16	15840
	1Ah	Loop.n.Main.PV	Integer16	15841
	1Bh	Loop.n.Main.WorkingSP	Integer16	15842
	1Ch	Loop.n.Main.ActiveOut	Integer16	15843

Enter 15843 as the Modbus Destination, and pick Loop.1.Main.AutoMan for the Source and set LetterBox to Yes.

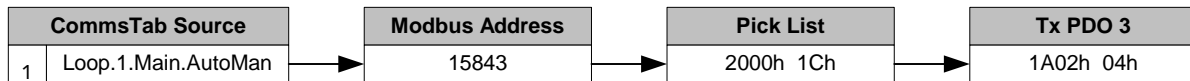
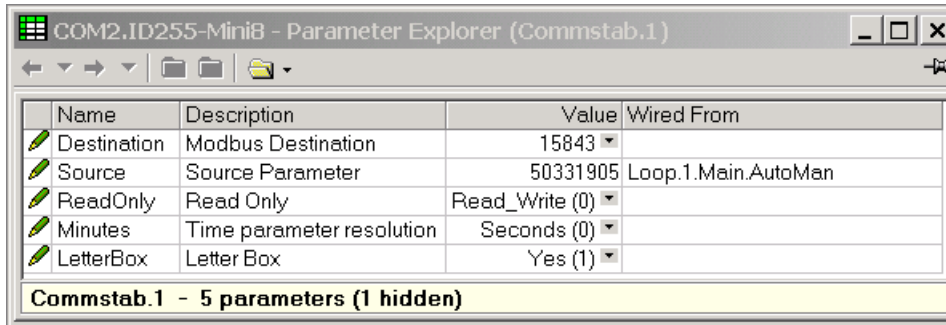

10.8.8.3 Commstab Example 3

Remap Transmit PDO 3 sub index 04h with UsrVal.3.Val, not using letter boxing so that no matter what the loop instance UsrVal.3.Val will be transmitted:

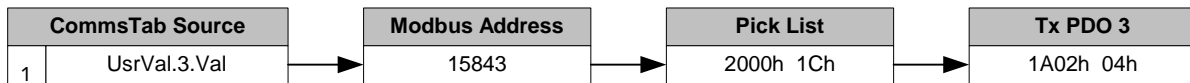
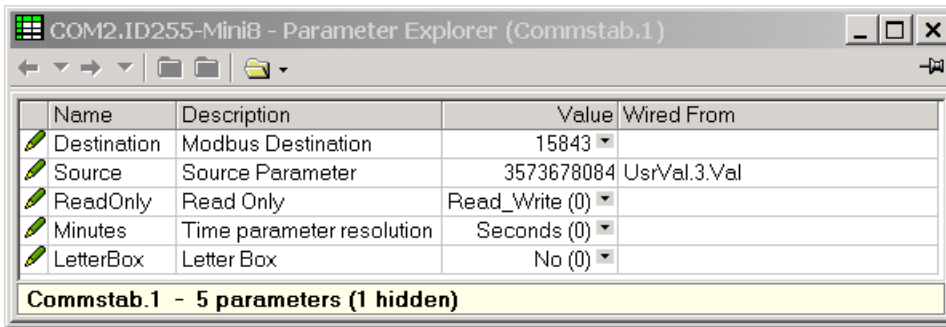

☺ Use Commstab to remap PDO blocks. It is simpler and the remapping is saved in the Mini8 controller clone file.

10.8.9 Remapping over the network

10.8.9.1 Using SDO communications

It is possible to remap any of the PDOs with entries from the Pick List using SDO communications. The following procedure must be followed:

1. Disable PDO by setting bit 31 sub index 1 of the PDOs communication object.
2. Deactivate PDO mapping object by writing '0' to sub index 0 of the PDOs mapping object.
3. Re-map sub indices 1 - 4 with the new mappings
4. Activate PDO mapping object by writing the number of entries to sub index 0 of the PDOs mapping object
5. Enable PDO by resetting bit 31 sub index 1 of the PDOs communication object.

For example, remapping Receive PDO1 of a Mini8 controller with a node address of 1 with UsrVal.1-4.Vals the following 8 "writes" must be executed:

Step	Object	Sub Index	Data
1.	1400h	01h	01 02 00 80
2.	1600h	00h	00
3.	1600h	01h	10 C3 00 20
		02h	10 C4 00 20
		03h	10 C5 00 20
		04h	10 C6 00 20
4.	1600h	00h	04
5.	1400h	01h	01 02 00 00

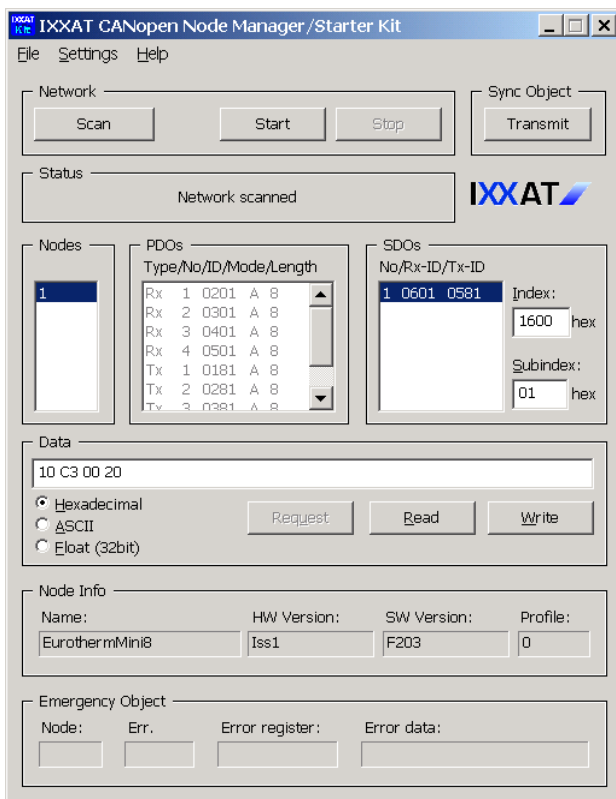

This is the screen shot of the first write in section 3 above.

This uses the Node Manager (a simple CANopen master) to write the values.

The **Node Manager** is a software tool supplied by **IXXAT**
 IXXAT
 Leibnizstr. 15
 D 88250
 Weingarten.
www.ixaat.de
info@ixaat.de

10.8.9.2 Using Device Configuration Software.

This shows one step of the example above using configuration software.

From the CANopen parameter tables in Appendix C UserVal 1 to 4 have sub-index C3h to C6h, or 195 to 198 so delete the existing elements in the Mapped Objects and add elements 195 to 198.

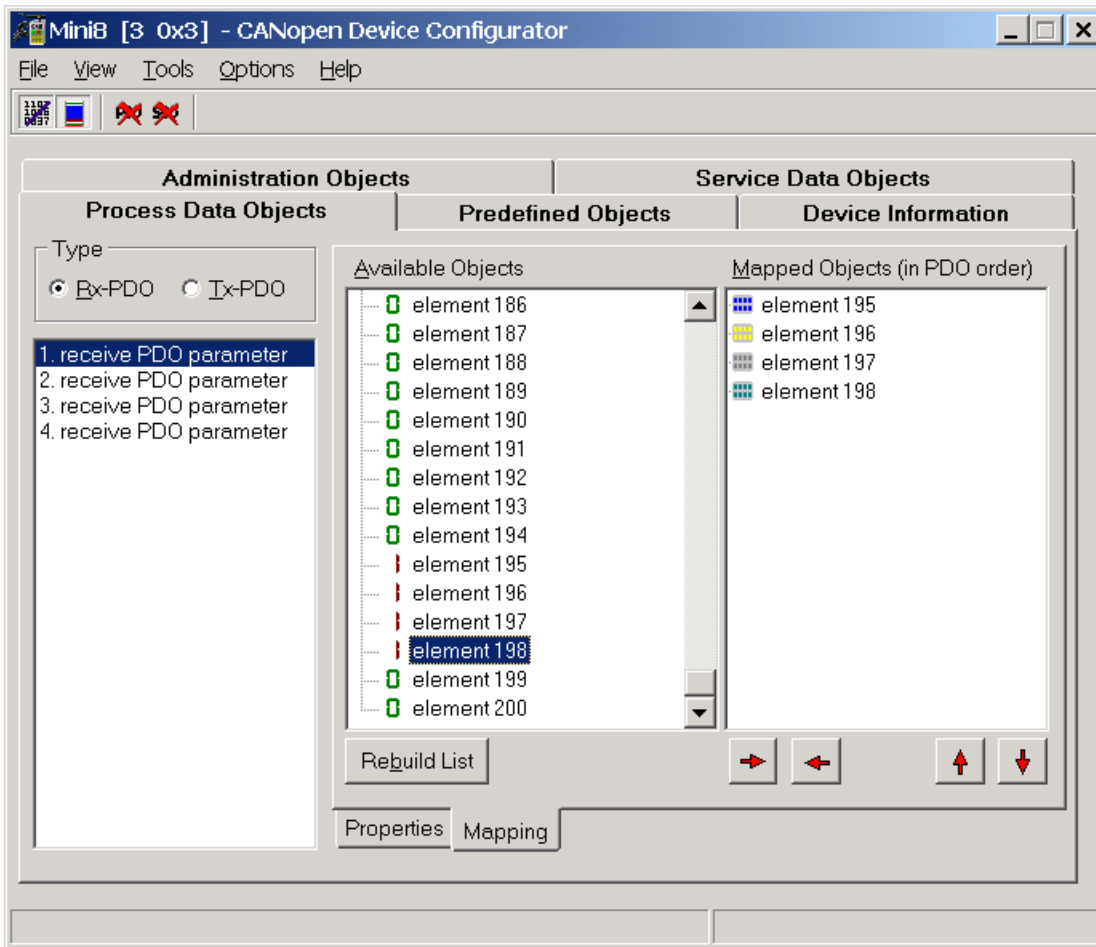

Screen shot of the **CANopen Configuration Studio**, a software tool supplied by **IXXAT**.

The remapping of a PDO, as shown in both examples above, is retained in RAM and would be lost if the instrument was turned off or if the PDO was remapped again. If the remapping needs to be retained then it must be 'STORED' in Non Volatile memory. See Store & Restore in General Communication Parameters.

10.8.10 Enabling & Disabling PDO Change of State transmission.

It is possible to change the way a transmit PDO works - either cyclically or on change of state (COS), or both. Object Index 2002h allows COS transmission of PDOs to be enabled or disabled.

Object Index	Sub Index	Parameter	Data Type	Values
2002h	00h	TxPDO COS Enables	Unsigned8	Bit Mask i.e. 0 = No TxPDOs transmitted on COS 1 = TxPDO 1 transmitted on COS 2 = TxPDO 2 transmitted on COS 3 = TxPDOs 1 & 2 transmitted on COS ... 16 = TxPDOs 1- 4 transmitted on COS

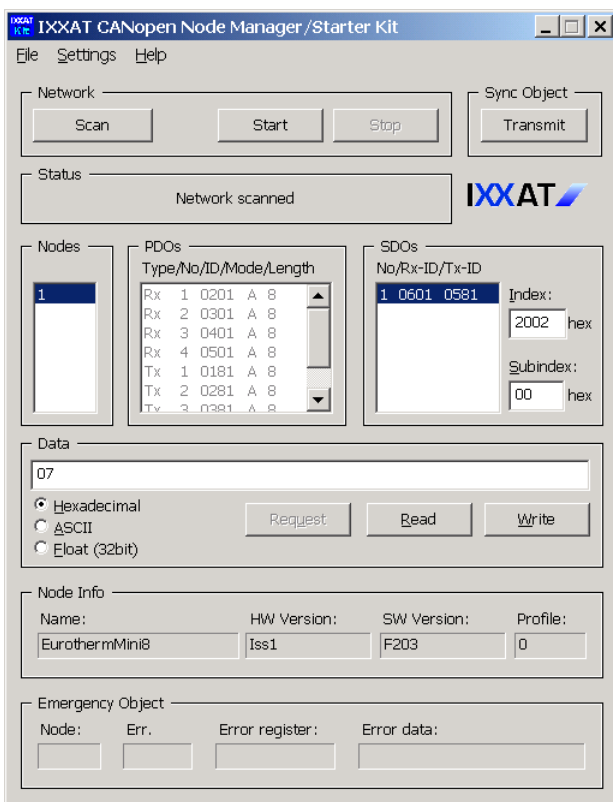

As default PDO 1 & 2 only transmit on change of state, 3 & 4 transmit cyclically so the default bit mask value is 3 (0011).

To make PDO 3 also transmit on change of state the third bit must be set so the value must be written as 7 (0111).

In order for PDOs to be transmitted cyclically, sub-index 05h of the PDOs communication object should be set with the time required in multiples of 1ms. A value of 0 will disable the cyclic PDO transmission.

10.8.11 General Communication Objects

10.8.11.1 Device Type Information

Index	Sub Index	Bit	Description	Value (U32)
1000h	00h	0 - 15	Device Profile Number:	0 (<i>Generic Device</i>)
		16 - 31	Additional Information:	0 (<i>Generic Device</i>)

10.8.11.2 Error Register

Index	Sub Index	Bit	Description	Value (U32) Bit set = error
1001h	00h	0	Generic Error:	Mandatory Bit set = ANY error
		1	Current:	<i>not supported</i>
		2	Voltage:	<i>not supported</i>
		3	Temperature:	<i>not supported</i>
		4	Communication Error:	Bit set = error
		5	Device Profile Defined Error:	<i>not supported</i>
		6	Reserved:	<i>Always zero</i>
7	Manufacture Specific Error:	<i>not supported</i>		

10.8.11.3 Manufacturer Device Name

Index	Sub Index	Description	Value (String)
1008h	00h	Manufacturer Device Name	EurothermMini8

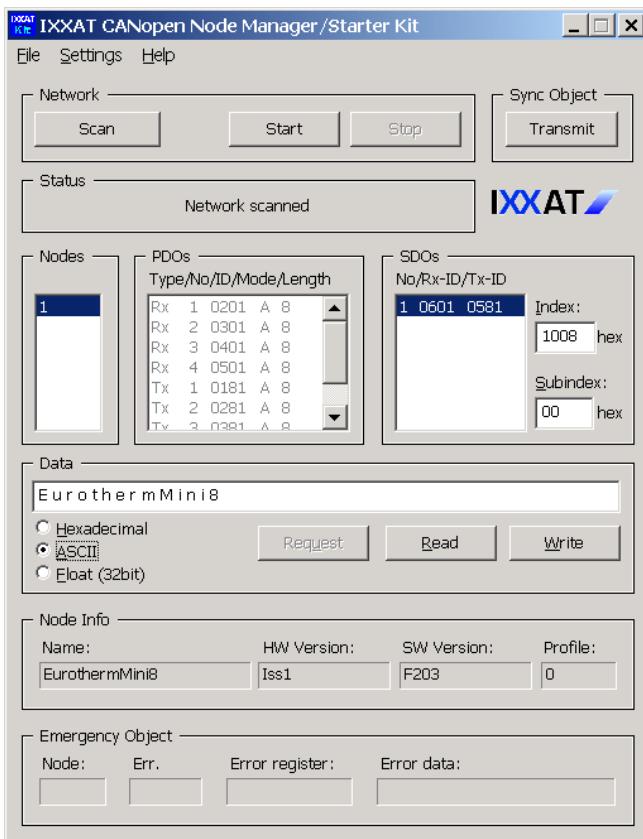

Select ASCII as the format and the text name will be displayed.

10.8.11.4 Manufacturer Hardware Version

This will indicate the issue of the CANopen daughter board.

Index	Sub Index	Description	Value (String)
1009h	00h	Manufacturer Hardware Version	e.g. Iss1

10.8.11.5 Manufacturer Software Version

This will indicate the software version of the instrument firmware.

Index	Sub Index	Description	Value (String)
100Ah	00h	Formal Release (n: Phase m: Minor Revision)	Vn.mm
		Engineering Release (n: Phase m: Minor Revision)	En.mm

10.8.11.6 Store & Restore

The Mini8 controller CANopen Interface allows the saving of PDO Mapping and Communication objects in non-volatile memory giving them three possible settings: Factory/Default settings, Power-On settings and Current settings. This allows the specified objects to be loaded with or set to different values upon certain events. The following diagram depicts the operational usage of each of the three settings:

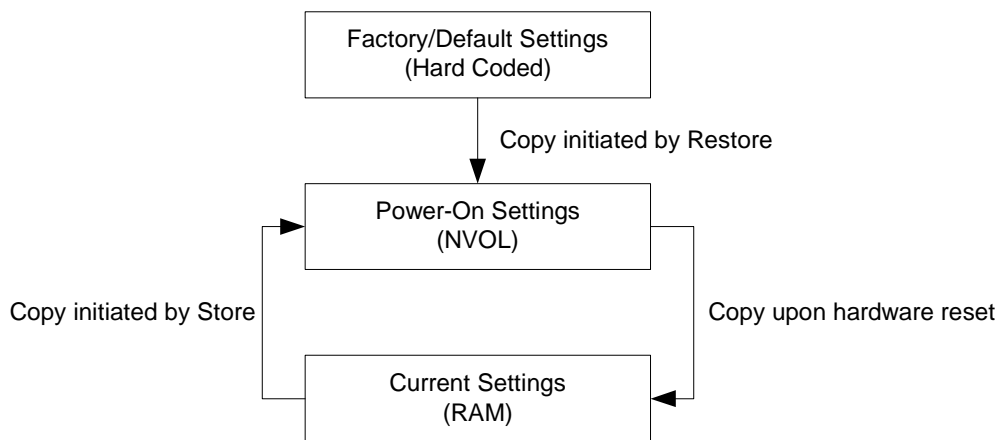

Object Index	Sub Index	Parameter	Data Type	Values
2001h	00h	Non-volatile Memory Status	Unsigned8	0 = Nonvol Data Invalid 1 = Data in the process of being stored 2 = Nonvol Data Valid

Store

Index	Sub Index	Description
1010h	00h	Largest Sub-Index supported (1)
	01h	Save all parameters (PDO mapping & Communication Objects)

The Mini8 controller CANopen Interface supports the saving of parameters on request only i.e. does not support the saving of parameters autonomously. This is indicated when sub-index **01h** is read:

Bit	Value	Meaning
31 - 2	0	Reserved
1	0	Device does not save parameters autonomously
0	1	Device saves parameters on command

In order to avoid saving parameters by mistake, saving is only executed when a specific signature is written to sub-index 01h. The signature is "save":

	MSB			LSB
ASCII:	e	v	a	s
Hex:	65h	76h	61h	73h

Or Using the IXXAT Node Manager, select ASCII Data and write 'save'

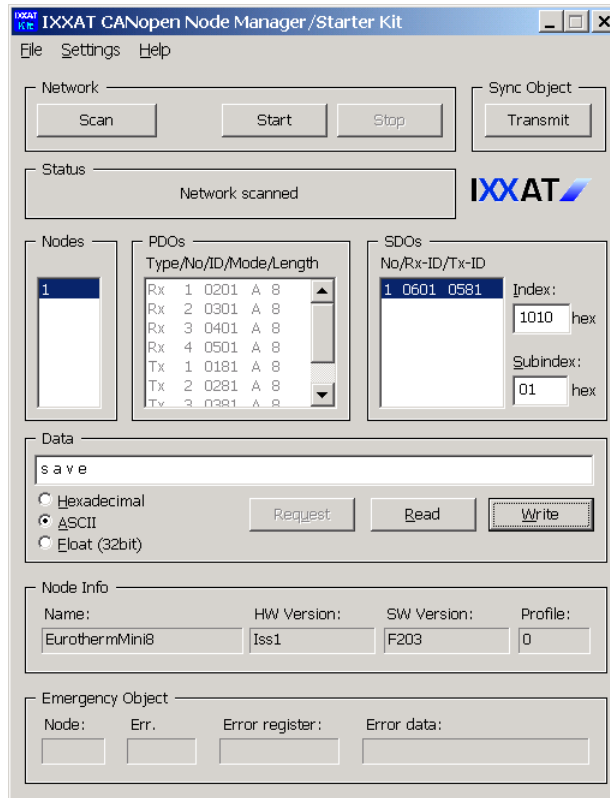

It should be noted that whilst in the process of saving the parameter data to non-volatile memory it is not possible to write to the parameters that are currently being saved.

Restore

Index	Sub Index	Description
1011h	00h	Largest Sub-Index supported (1)
	01h	Restore all parameters (PDO mapping & Communication Objects)

In order to avoid restoring parameters back to default settings by mistake, restoring is only executed when a specific signature is written to sub-index 01h. The signature is "load":

	MSB			LSB
ASCII:	d	a	o	l
Hex:	64h	61h	6Fh	6Ch

On reception of the correct signature the default parameter values are set to valid but will only take effect upon device reset or after a power cycle.

10.8.11.7 Heartbeat Time

A heartbeat message will be generated cyclically at this interval (specified in ms). The default value is 0 indicating that the heartbeat messages are disabled.

Index	Sub Index	Description	Value milli-secs (U32)
1017h	00h	Heartbeat Message Interval 0 = disabled.	0

10.8.11.8 Identity Object

Index	SubIndex	Description	
1018h	0	Number of Sub Index entries = 4	
	1	Unique Vendor ID = 0x000001BC	
	2	Product Code = E800	
	3	Revision Number =	
		Bits	Description
		0 - 15	Minor Revision Number (Initially: 0001h)
	16 - 31	Major Revision Number (Initially: 0001h)	
4	Serial Number (32-bit interface board number entered by Eurotherm)		

10.9 Profibus

Up to 127 Nodes can be connected to a Profibus Network and the address is set via the comms DIP switches. The Baud Rate is auto-detected and set by the master.

Sw	OFF	ON
8	Not Used	
7	-	Address 64
6	-	Address 32
5	-	Address 16
4	-	Address 8
3	-	Address 4
2	-	Address 2
1	-	Address 1



Example shows an address 68

OFF ↔ ON

A further description of Profibus is given in the Profibus Communications Handbook Part No HA026290.

10.9.1 Profibus Parameters

Folder - Comms		Sub-folder: FC (Field Communications)		
Name	Parameter Description	Value	Default	Access Level
Ident	Comms Module Identity	Profibus RJ45 Profibus D-type	Profibus	R/O
Protocol	Digital communications protocol	Profibus	Profibus	Conf
Address	Instrument address	0 to 126 Only writable if DIP switches are set to 0.	1	Oper
Network Status	Network Status	See section 10.7.1 DeviceNet parameters for the list		R/O
WDFlag	Network watchdog flag	Off	This flag is ON when the Network communications have stopped addressing this instrument for longer than the Timeout time. It will be set by the Watchdog process and may be cleared Automatically or Manually according to the value of the Watchdog Action parameter.	
		On		
WDAct	Network watchdog action. The Watchdog Flag may be cleared Automatically upon reception of valid messages or Manually by a parameter write or a wired value.	Man	The Watchdog Flag must be cleared manually - either by a parameter write or a wired value.	Conf
		Auto	The Watchdog Flag will be automatically cleared when the Network Comms resume - according to the value in the Recovery Timer.	
WDTime	Network Watchdog Timeout If the Network communications stop addressing the instrument for longer than this value, the Watchdog Flag will become active.	h:m:s:ms A value of 0 disables the watchdog		Conf

10.10 EtherNet (Modbus TCP)

10.10.1 Instrument setup

It is recommended that you setup the communications settings for each instrument *before connecting it to any EtherNet network*. This is not essential but network conflicts may occur if the default settings interfere with equipment already on the network. By default the instruments are set to a fixed IP address of 192.168.111.222 with a default SubNet Mask setting of 255.255.255.0.

IP Addresses are usually presented in the form "xxx.xxx.xxx.xxx". In the instrument Comms folder *each element of the IP Address is shown and configured separately*.

"IP address 1" relates to the first set of three digits, IP address 2 to the second set of three digits and so on. This also applies to the SubNet Mask, Default Gateway and Preferred master IP Address.

Each EtherNet module contains a unique MAC address, normally presented as a 12 digit hexadecimal number in the format "aa-bb-cc-dd-ee-ff".

In the **Mini8** controllers MAC addresses are shown as 6 separate **decimal** values in iTools. MAC1 shows the first pair of digits in **decimal**, MAC2 shows the second pair of digits and so on.

10.10.2 Unit Identity

The Modbus TCP Specification includes the 'normal' Modbus address as part of the packaged Modbus message - where it is called the Unit Identifier. If such a message is sent to an EtherNet / Serial gateway, the Unit Ident is essential to identify the slave instrument on the serial port. When a stand alone EtherNet instrument is addressed however, the Unit Ident is surplus to requirements since the IP address fully identifies the instrument. To allow for both situations the Unit Ident Enable parameter is used to enable or disable checking of the Unit Ident received from TCP. The enumerations produce the following actions:

'Instr': the received Unit Ident must match the Modbus address in the instrument or there will be no response.

'Loose': the received Unit Ident value is ignored, thus causing a reply regardless of the received Unit Ident.

'Strict': the received Unit Ident value must be 0xFF or there will be no reply.

10.10.3 Dynamic Host Configuration Protocol (DHCP) Settings

IP addresses may be 'fixed' - set by the user, or dynamically allocated by a DHCP server on the network.

This is set by Switch 8 on the DIL address switch.

If the IP Addresses are to be dynamically allocated the server uses the instrument MAC address to uniquely identify it.

For fixed IP Addresses set the IP address as well as the SubNet Mask. These must be configured into the instrument using iTools. Remember to note the allocated addresses.

10.10.3.1 Fixed IP Addressing

Address Switch 8 **OFF**. In the "**Comms**" folder of the instrument the "**DHCP enable**" parameter will be set to "**Fixed**". Set the IP address and SubNet Mask as required.

10.10.3.2 Dynamic IP Addressing

Address Switch 8 **ON**. In the "**Comms**" folder of the instrument the "**DHCP enable**" parameter will be set to "**Dynamic**". Once connected to the network and powered, the instrument will acquire its "IP address", "SubNet Mask" and "Default gateway" from the DHCP Server and display this information within a few seconds.

10.10.3.3 Default Gateway

The "**Comms**" tab also includes configuration settings for "**Default Gateway**", these parameters will be set automatically when Dynamic IP Addressing is used. When fixed IP addressing is used these settings are only required if the instrument needs to communicate wider than the local area network i.e. over the internet.

10.10.3.4 Preferred Master

The "Comms" tab also includes configuration settings for "Preferred Master". Setting this IP address to the IP Address of a particular PC will guarantee that one of the 4 available Ethernet sockets will always be reserved for that PC (reducing the number of available sockets for anonymous connections to 3).

Sw	OFF	ON
8	DHCP fixed	DHCP dynamic
7	Not used	-
6	Not used	-
5	-	Modbus Address 16
4	-	Modbus Address 8
3	-	Modbus Address 4
2	-	Modbus Address 2
1	-	Modbus Address 1



Example shows dynamic DHCP and Modbus address 5

OFF ↔ ON

10.10.4 iTools Setup

iTools configuration package, version V5.60 or later, may be used to configure Ethernet communications. The following instructions configure Ethernet.

To include a Host Name/Address within the iTools scan:-

1. Ensure iTools is **NOT** running before taking the following steps
2. Within Windows, click 'Start', the 'Settings', then 'Control Panel'
3. In control panel select 'iTools'
4. Within the iTools configuration settings select the 'TCP/IP' tab
5. Click the 'Add' button to add a new connection
6. Enter a name for this TCP/IP connection
7. Click the 'Add' button to add the IP address of the instrument in the 'Host Name/ Address' section
8. Click 'OK' to confirm the new IP Address you have entered
9. Click 'OK' to confirm the new TCP/IP port you have entered
10. You should now see the TCT/IP port you have configured within the TCP/IP tab of the iTools control panel settings

iTools is now ready to communicate with an instrument at the IP Address you have configured.

10.10.5 EtherNet Parameters

These are listed in the 'Comms' → 'FC' list in iTools.

Folder - Comms		Sub-folder: FC			
Name	Parameter Description	Value		Default	Access Level
Ident	Identifies that the EtherNet comms module is fitted.	EtherNet		EtherNet	Read only
Protocol	Digital communications protocol	EtherNet		EtherNet	Read only
Address	Comms Address	1 to 253		1	Oper
WDFlag	Network watchdog flag	Same as previous protocols - see section 10.4.2 for example.			
WDAct	Network watchdog action				
WDTime	Network watchdog timeout				
UnitID Enable	Unit Identity Enable Enable/disable checking of the ModbusTCP Unit Identity field.	Strict	Disable - Unit ID must be 0xFF (255)	Strict	Conf
		Loose	Disable - Unit ID ignored		
		Instr	Enable - Unit ID must be instrument address		
DHCP enable	DHCP Type Select whether IP address / subnet mask etc are as configured (Fixed) or supplied from EtherNet server (Dynamic).	Fixed	Manually set IP addresses (Address Switch 8 = OFF)		RO
		Dynamic	IP addresses set by DCHP server (Address Switch 8 = ON)		
IP Address 1	1st Byte IP address	IP address format is X X X . X X X . X X X . X X X . 1 st Byte. 2 nd Byte. 3 rd Byte. 4 th Byte. Range 0 to 255		192	Conf
IP Address 2	2nd Byte IP address			168	
IP Address 3	3rd Byte IP address			111	
IP Address 4	4th Byte IP address			222	
Subnet Mask 1	1st Byte Subnet Mask	Subnet mask format is X X X . X X X . X X X . X X X . 1 st Byte. 2 nd Byte. 3 rd Byte. 4 th Byte. Range 0 to 255		255	Conf
Subnet mask 2	2nd Byte Subnet Mask			255	
Subnet Mask 3	3rd Byte Subnet Mask			255	
Subnet Mask 4	4th Byte Subnet Mask			0	
Default Gateway 1	1st Byte Default Gateway	Default gateway format is X X X . X X X . X X X . X X X . 1 st Byte. 2 nd Byte. 3 rd Byte. 4 th Byte. Range 0 to 255		0	Conf
Default Gateway 2	2nd Byte Default Gateway				
Default Gateway 3	3rd Byte Default Gateway				
Default Gateway 4	4th Byte Default Gateway				
Pref mstr IP 1	1st Byte Preferred Master IP address	Preferred master IP address format is X X X . X X X . X X X . X X X . 1 st Byte. 2 nd Byte. 3 rd Byte. 4 th Byte. Range 0 to 255		0	Conf
Pref mstr IP 2	2nd Byte Preferred Master IP address				
Pref mstr IP 3	3rd Byte Preferred Master IP address				
Pref mstr IP 4	4th Byte Preferred Master IP address				
MAC1	MAC address 1	A unique MAC address is allocated to every EtherNet device. MAC addresses are 6 bytes in length and are shown in HEX format, for example: A A - B B - C C - D D - E E - F F 1 st Byte 2 nd Byte 3 rd Byte 4 th Byte 5 th Byte 6 th Byte		0	R/O
MAC2	MAC address 2				
MAC3	MAC address 3				
MAC4	MAC address 4				
MAC5	MAC address 5				
MAC6	MAC address 6				
EtherNet Status	EtherNet network status	Running	Network connected and working		R/O
		Offline	Network not connected or working		
		Init	Network initialising		
		Ready	Network ready to accept connection		

10.11 EtherNet/IP

EtherNet/IP (EtherNet/Industrial Protocol) is a communication system suitable for use in industrial environments. It allows industrial devices to exchange time-critical application information. These devices include simple I/O devices such as sensors/actuators, as well as more complex control devices such as robots or PLCs.

EtherNet/IP makes use of the CIP (Common Industrial Protocol), common network, transport and application layers currently implemented by DeviceNet and ControlNet. EtherNet/IP then makes use of the standard EtherNet and TCP/IP technology to transport CIP communications packets. The result is a common, open application layer on top of open and highly popular EtherNet and TCP/IP protocols.

EtherNet/IP provides a producer-consumer model for exchange of time-critical control data. The producer-consumer model allows the exchange of application information between a sending device (producer) and many other receiving devices (consumers) without the need to send data multiple times to multiple destinations.

A gateway communications option card is installed in the Mini8 controller to implement the EtherNet/IP server (Adapter).

10.11.1 Feature Switch

An 8-pole lever operated DIP switch is used to set the DHCP feature to off or on, and to force start up in the boot mode for software upgrades.

Switch 8 is used to switch DHCP mode ON (Dynamic) or OFF (Fixed).

All other switches are normally in the off state.

The boot mode requires all switches to be on.



Example shows dynamic DHCP 'Fixed'.

10.11.2 Configuration using iTools

iTools configuration package, version V8.68 or later, may be used to configure EtherNet communications.

Using the RJ11 configuration port (CC), connect the mini8 controller to the serial comms port of a pc running iTools.

Ensure the Feature switch is set as shown in the diagram above and scan for the instrument in the normal way.

10.11.2.1 Explicit Messaging Inactivity Timeout

The encapsulation message (TCP packet) maximum size is 300 bytes. If a received message length is greater than 300 bytes then the TCP connection is closed.

10.11.3 EtherNet/IP Parameters

EtherNet/IP parameters are shown under 'Comms' → 'FC' as shown in

Figure 10-2 below.

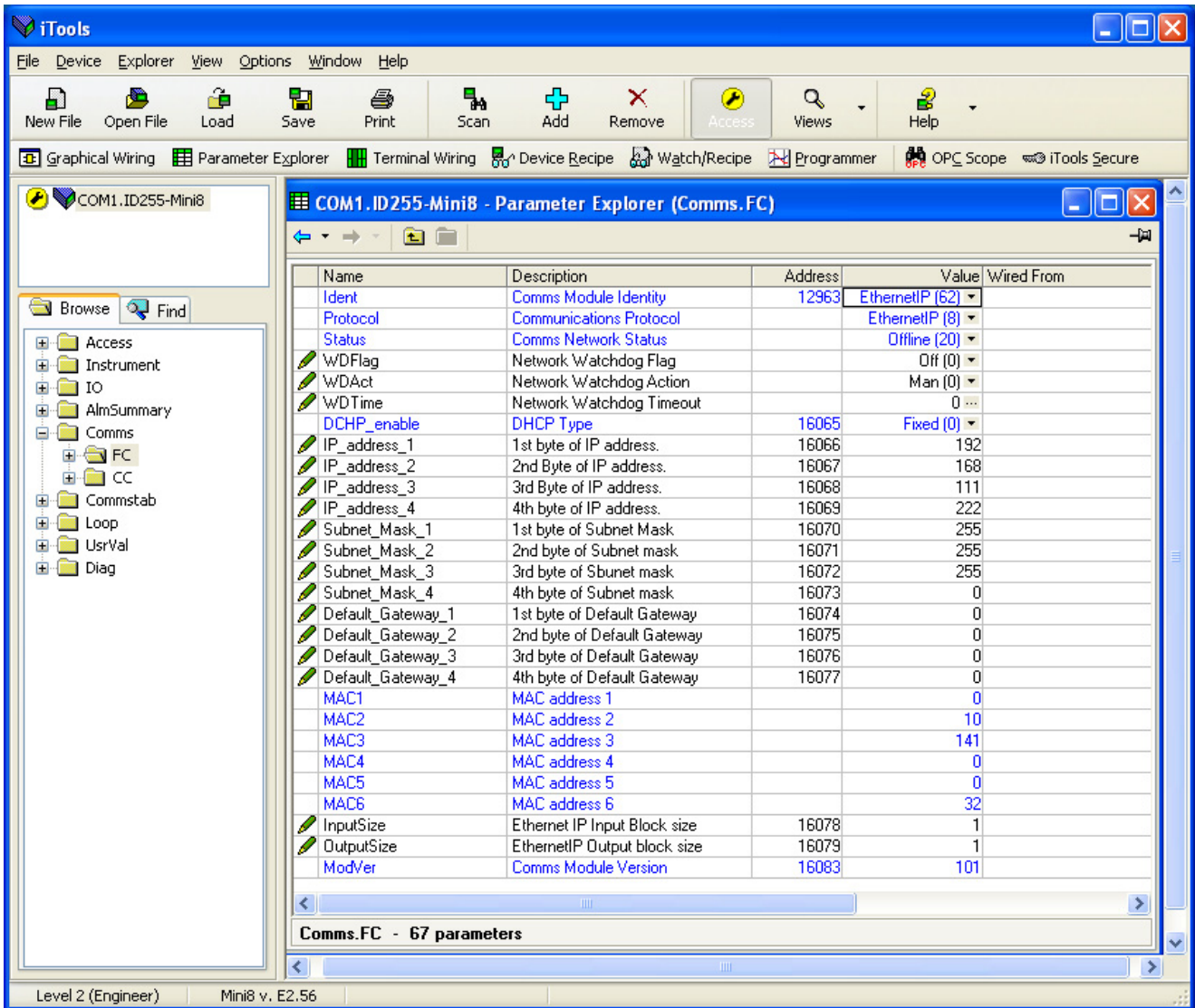

Figure 10-2: EtherNet/IP Parameters

The parameter list is similar to the EtherNet TCP section 10.10.5 without the Preferred Master IP addresses (PrefMstr). There are three additional parameters:-

Folder - Comms		Sub-folder: FC		
Name	Parameter Description	Value and enumeration	Default	Access Level
InputSize	Ethernet IP Input Block Size	Range 1 to 100 See Input Definition Table below	1	Conf
OutputSize	EtherNet/IP Output Block Size	Range 1 to 100 See Output Definition Table below	1	Conf
ModVer	Module firmware version	This is an integer value where the least two significant digits are the minor version. For example: A value of 201 indicates 2.01 - major revision 2, minor revision 01.		R/O

The definitions are shown in the following two sections.

10.11.4 Input Definition Table

The following table shows the Default Input parameter list:

Item	Description	Modbus Address decimal / (HEX)	Notes
1	Loop.1.Main.PV	15360 / (3C64)	The default Input Block Size value (Comms.InputSize) matches this list. All of this area may be redefined by use of the CommsTab Function Block, do not forget to set the Input Block Size value for the configured number of parameters. The Commstab Data Format option must be set to "Integer" to work with EtherNet/IP
2	Loop.1.Main.WorkingSP	15361 / (3C01)	
3	Loop.1.Main.ActiveOut	15362 / (3C02)	
4	Loop.2.Main.PV	15363 / (3C03)	
5	Loop.2.Main.WorkingSP	15364 / (3C04)	
6	Loop.2.Main.ActiveOut	15365 / (3C05)	
7	Loop.3.Main.PV	15366 / (3C06)	
8	Loop.3.Main.WorkingSP	15367 / (3C07)	
9	Loop.3.Main.ActiveOut	15368 / (3C08)	
10	Loop.4.Main.PV	15369 / (3C09)	
11	Loop.4.Main.WorkingSP	15370 / (3C0A)	
12	Loop.4.Main.ActiveOut	15371 / (3C0B)	
13	Loop.5.Main.PV	15372 / (3C0C)	
14	Loop.5.Main.WorkingSP	15373 / (3C0D)	
15	Loop.5.Main.ActiveOut	15374 / (3C0E)	
16	Loop.6.Main.PV	15375 / (3C0F)	
17	Loop.6.Main.WorkingSP	15376 / (3C10)	
18	Loop.6.Main.ActiveOut	15377 / (3C11)	
19	Loop.7.Main.PV	15378 / (3C12)	
20	Loop.7.Main.WorkingSP	15379 / (3C13)	
21	Loop.7.Main.ActiveOut	15380 / (3C14)	
22	Loop.8.Main.PV	15381 / (3C15)	
23	Loop.8.Main.WorkingSP	15382 / (3C16)	
24	Loop.8.Main.ActiveOut	15383 / (3C17)	
25	AlmSummary.General.AnAlarmStatus1	15384 / (3C18)	
26	AlmSummary.General.AnAlarmStatus2	15385 / (3C19)	
27	AlmSummary.General.AnAlarmStatus3	15386 / (3C1A)	
28	AlmSummary.General.AnAlarmStatus4	15387 / (3C1B)	
29	AlmSummary.General.SBrkAlarmStatus1	15388 / (3C1C)	
30	AlmSummary.General.SBrkAlarmStatus2	15389 / (3C1D)	
31	AlmSummary.General.SBrkAlarmStatus3	15390 / (3C1E)	
32	AlmSummary.General.SBrkAlarmStatus4	15391 / (3C1F)	
33	AlmSummary.General.CTAlarmStatus1	15392 / (3C20)	
34	AlmSummary.General.CTAlarmStatus2	15393 / (3C21)	
35	AlmSummary.General.CTAlarmStatus3	15394 / (3C22)	
36	AlmSummary.General.CTAlarmStatus4	15395 / (3C23)	
37	AlmSummary.General.NewAlarm	15396 / (3C24)	
38	AlmSummary.General.AnyAlarm	15397 / (3C25)	
39	AlmSummary.General.NewCTAlarm	15398 / (3C26)	
40	Programmer.Run.ProgStatus	15399 / (3C27)	
41 to 100	These parameters are undefined by default	15400 to 15459 / (3C28-3C63)	
	Total Length 100 words = 200 bytes		

10.11.5 Output Definition Table

The following table shows the Default Output parameter list:

Item	Description	Modbus Address / (HEX)	Notes
1	Loop.1.Main.TargetSP	15460 / (3C64)	The default Output Block Size value (Comms.OutputSize) matches this list. All of this area may be redefined by use of the CommsTab Function Block, do not forget to set the Output Block Size value for the configured number of parameters. The Commstab Data Format option must be set to "Integer" to work with EtherNet/IP
2	Loop.1.Main.AutoMan	15461 / (3C65)	
3	Loop.1.OP.ManualOutVal	15462 / (3C66)	
4	Loop.2.Main.TargetSP	15463 / (3C67)	
5	Loop.2.Main.AutoMan	15464 / (3C68)	
6	Loop.2.OP.ManualOutVal	15465 / (3C69)	
7	Loop.3.Main.TargetSP	15466 / (3C6A)	
8	Loop.3.Main.AutoMan	15467 / (3C6B)	
9	Loop.3.OP.ManualOutVal	15468 / (3C6C)	
10	Loop.4.Main.TargetSP	15469 / (3C6D)	
11	Loop.4.Main.AutoMan	15470 / (3C6E)	
12	Loop.4.OP.ManualOutVal	15471 / (3C6F)	
13	Loop.5.Main.TargetSP	15472 / (3C70)	
14	Loop.5.Main.AutoMan	15473 / (3C71)	
15	Loop.5.OP.ManualOutVal	15474 / (3C72)	
16	Loop.6.Main.TargetSP	15475 / (3C73)	
17	Loop.6.Main.AutoMan	15476 / (3C74)	
18	Loop.6.OP.ManualOutVal	15477 / (3C75)	
19	Loop.7.Main.TargetSP	15478 / (3C76)	
20	Loop.7.Main.AutoMan	15479 / (3C77)	
21	Loop.7.OP.ManualOutVal	15480 / (3C78)	
22	Loop.8.Main.TargetSP	15481 / (3C79)	
23	Loop.8.Main.AutoMan	15482 / (3C7A)	
24	Loop.8.OP.ManualOutVal	15483 / (3C7B)	
25 to 100	These parameters are undefined by default	15484 to 15559 / (3C7B-3CC7)	
	TOTAL LENGTH 100 words = 200 bytes.		

10.11.6 Requested Packet Interval

The EtherNet/IP module can support Requested Packet Interval (RPI) values down to 100ms. However, depending upon the size of Input/Output blocks, the maximum rate at which a new value will be produced/consumed is every 500ms. RPI values less than 500ms will, therefore, repeat previously produced values.

To minimise network traffic, it is recommended to set the RPI to as large a value as is reasonable for the application.

10.12 Example - Connect mini8 Controller to Allen-Bradley PLC via EtherNet/IP

10.12.1 Installation

1. Install the PLC software according to the instructions supplied with the PLC. For this particular PLC, once installation is complete, the 'RSLinx Classic' and 'RSLogix 5000' software items (AMONGST OTHERS) must be present. RSLinx classic is used to provide a link between the PLC network and Windows, and RSLogix 5000 is configuration and programming software for the PLC.
2. Use a cross-over type serial cable to connect one of the pc ports to the serial port (typically a 9-way D-Type connector) of the PLC
3. Connect an EtherNet cable between the EtherNet port on the PLC (typically an RJ45 socket) and the mini8 controller. For a connection via a switch, a hub or directly to a Master, a Cat5e (straight through or cross-over) cable can be used.
4. Power up the PLC and the controller. Switch the PLC to 'Programmer' mode.

10.12.2 Setting Up The Link Between Windows And The Plc Network

5. Click on Start/All Programs/Rockwell software/RSLinx/RSLinx Classic. The 'RSLinx Classic' window opens.
6. Click on 'Communications' and select 'Configure Drivers'. When the 'Configure Drivers' window opens, select 'RS232 DF1 devices' in the 'Available Drive Types' pull down menu (Figure 10-3).

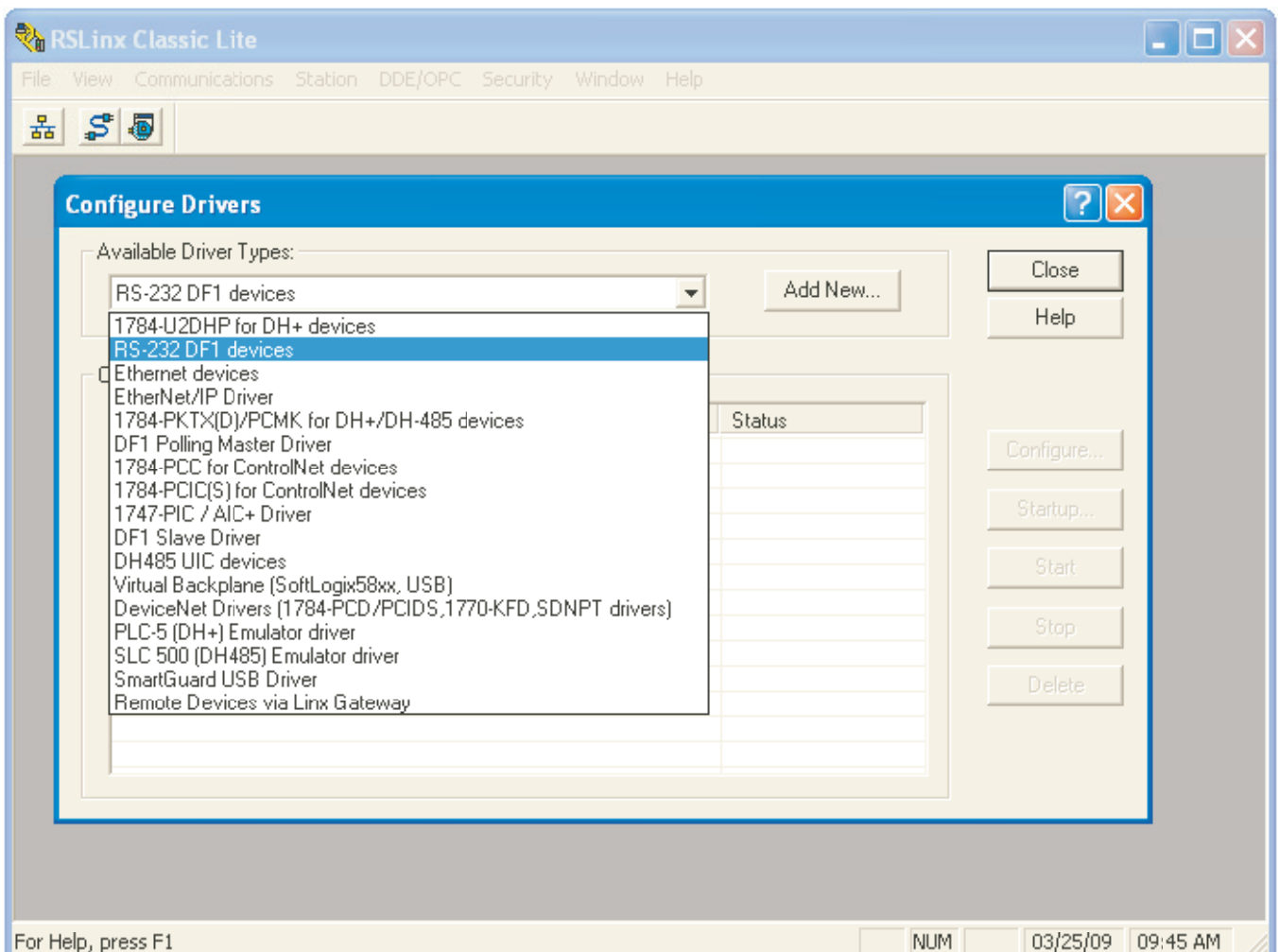

Figure 10-3: Configure Drivers

7. Click on 'Add New' and enter a suitable Driver Name in the pop-up window that then appears. Click on 'OK'. The 'Configure RS-232 DF1 devices' window opens (Figure 10-4).

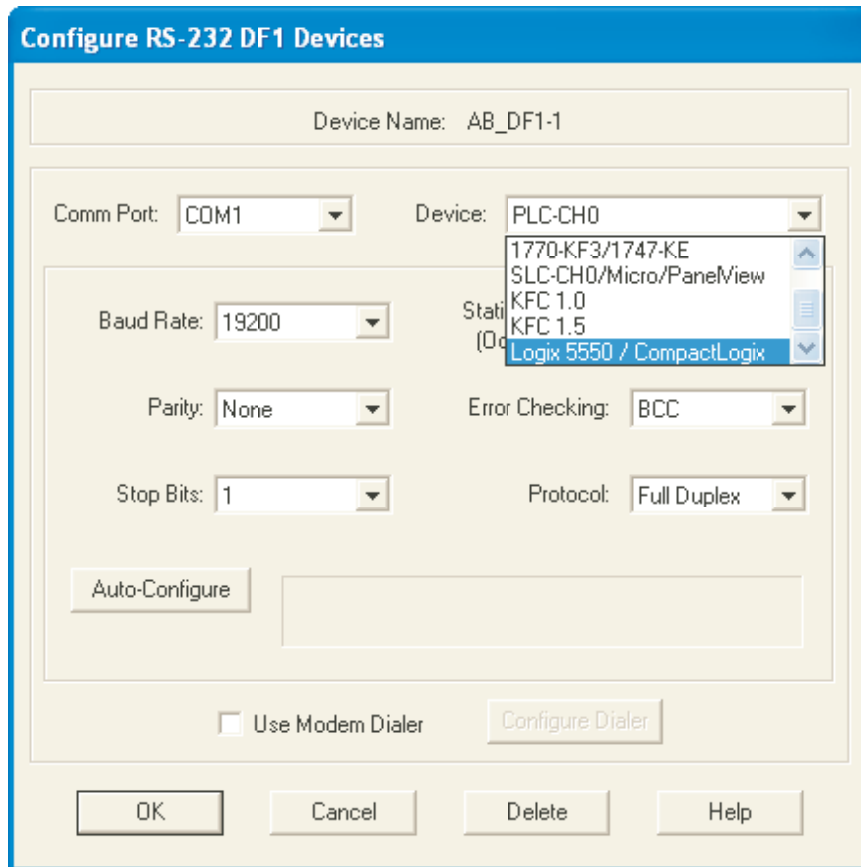

Figure 10-4: Configure RS232 DFI Devices

8. In the 'Device:' field pull-down menu, select the relevant device name. Select the PC COM port, and the relevant Baud Rate, Parity etc. (normally the defaults are acceptable). Click on 'Auto-Configure'.
9. When the Auto-Configure process is complete, click on 'OK', to close the 'Configure Drivers' window, and then minimise the 'RSLinx Classic' window.
10. Start the RSLogix 5000 program (from 'Start/All programs/... /RSLogix 5000'). When the 'Quick Start' window opens, close it.
11. At the top of the RSLogix 5000 window, click on the 'Who active' icon or click on 'Who Active' in the 'Communications' drop down menu. The 'Who Active' window opens.

10.12.3 Updating Firmware



Power must be maintained during the Update process (which may take some tens of minutes). Loss of power during update may render the PLC inoperative.

1. Select the relevant instrument (Figure 10-5) and click on 'Update Firmware'. In the 'Choose Firmware Revision' window, select the latest version. Click on 'Update'.
2. Click on 'Yes' or 'OK' as appropriate to accept all the warnings and notes, and wait for the process to complete and to be validated.
3. When the update process is complete, close the 'Who Active' window.

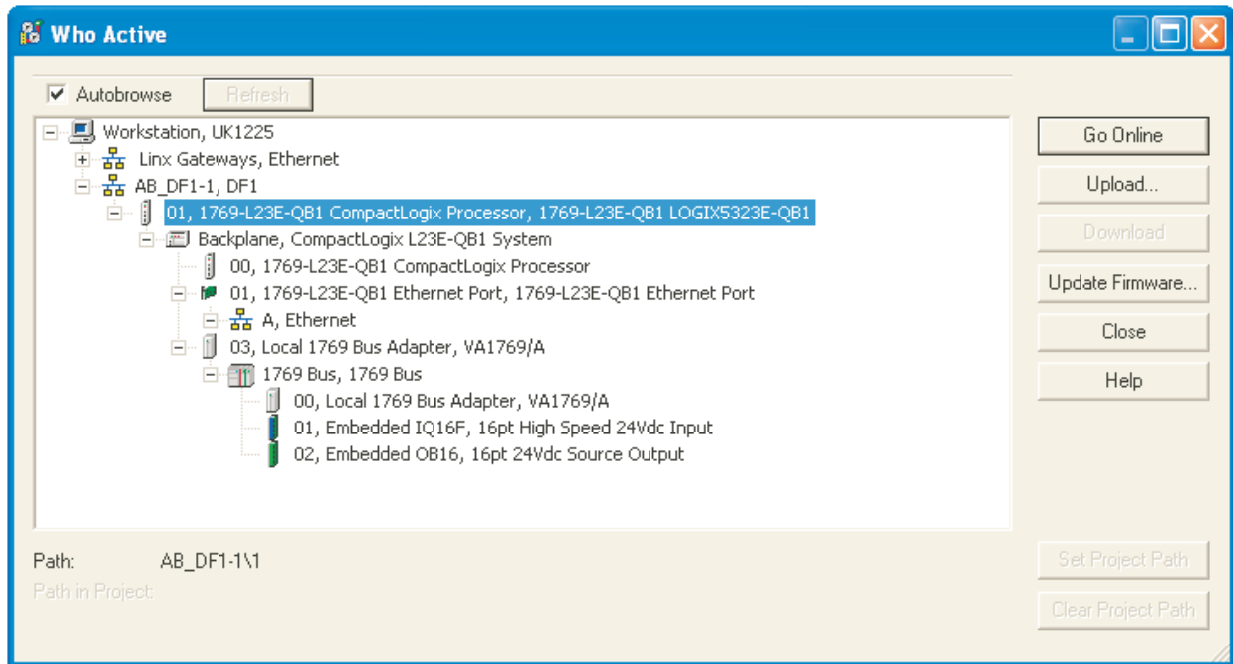

Figure 10-5: Who Active Window

10.12.4 Completing the Link

1. In the 'File' menu select 'New', or click on the 'New Tool' icon. The 'New Controller' window opens (Figure 10-6).

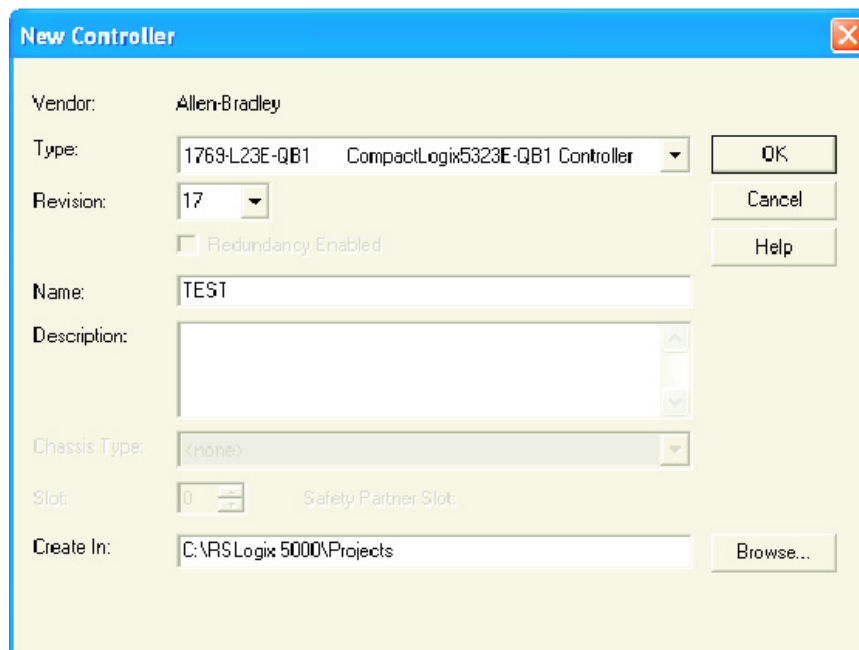



Figure 10-6: New Controller

2. Select the relevant PLC from the drop-down menu. Enter a name, if required and click on 'OK'. After some seconds, the selected controller's window opens.

3. Open the 'Who active' window. This is found under the Communications menu or the  icon. Select the relevant instrument from the hierarchy. At this point it is possible to download the project to the controller (PLC). Click on 'Download'.
4. When the download is complete, right click on the relevant EtherNet port in the left pane 'tree', and select 'Properties' (Figure 10-7).

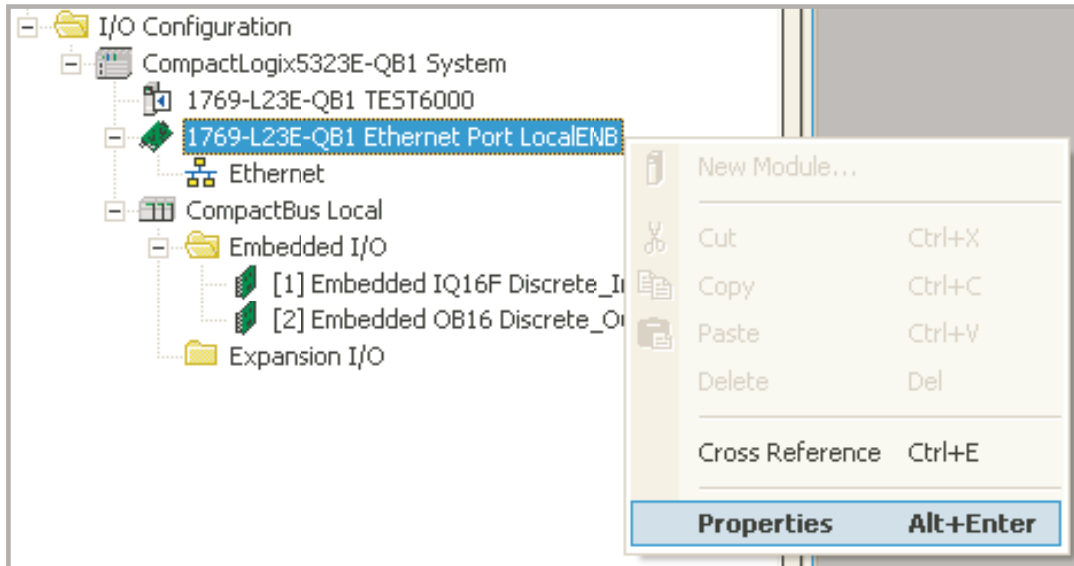
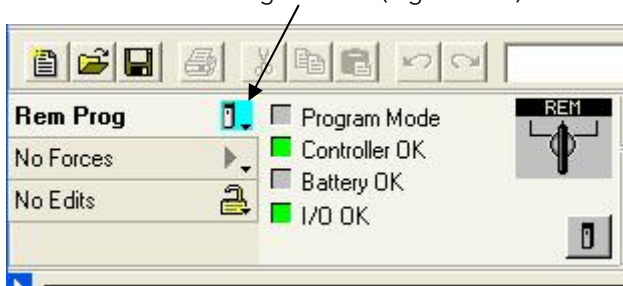

Figure 10-7: Properties

5. The Module Properties window opens. Select the 'Port Configuration' tab (shown if the configuration is being done through the serial port). For fixed IP Address applications, 'uncheck' the 'Enable BootP' check box, and enter an appropriate IP address and Subnet mask for the PLC.
6. Click on 'Set', and click on 'OK' on the warnings and notes displays.
7. Click on 'OK' to close the Properties window.
8. Left click on the 'Program' icon (Figure 10-8) and select 'Go OffLine' from the menu which appears.



This view is shown if the local switch is set to PROG.

Figure 10-8: 'Go OffLine' 'Go OnLine'

9. Connect the PLC to the EtherNet port (RJ45) of the PC.
10. Restore the RSLinxClassic window. To configure the PLC as an EtherNet driver, in the 'Communications' menu select 'Configure Drivers' then 'EtherNet/IP Driver'.
11. Click on 'Add New' and enter a name for the driver.
12. Select 'Browse local subnet' if this is not already selected.
13. Click on the relevant Network Card and Click on 'OK'.
14. Minimise the RSLinx window.

} This associates the software drivers with the physical hardware.

10.12.5 Creating a Network Scanner

1. In the left pane tree-view of the RSLogix 5000 window, right click on the EtherNet symbol and select 'New Module...'

Figure 10-9: New Module

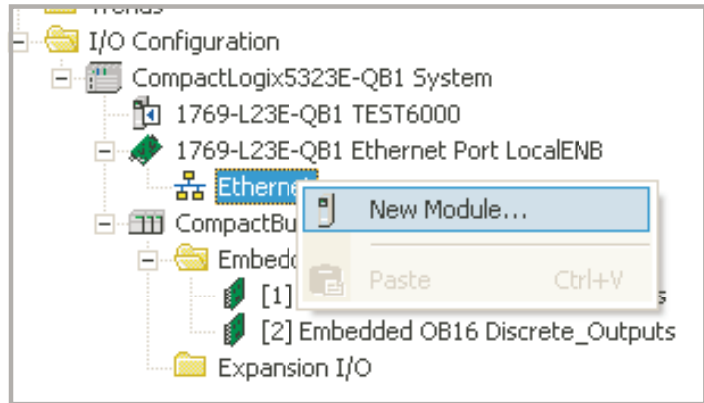

2. Expand the communications list (click on the + symbol)

Figure 10-10: Select Module

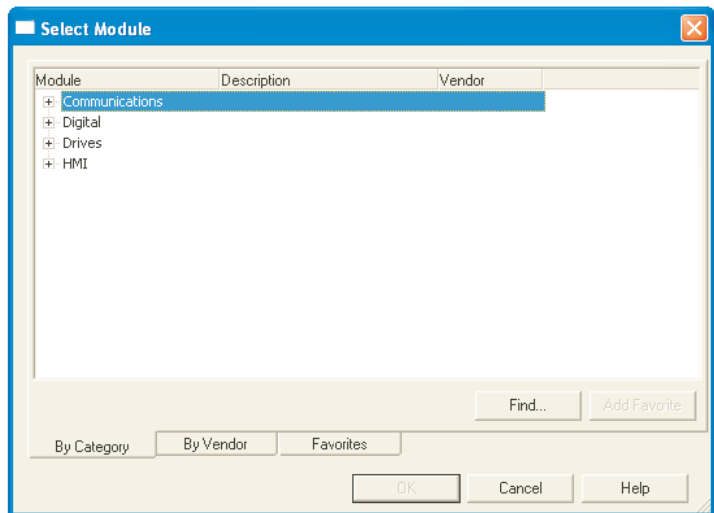

3. Using the scroll bar as necessary, click on the 'Generic EtherNet Module' item and click on 'OK' (or double click on the selected item).

Figure 10-11: Generic EtherNet Module

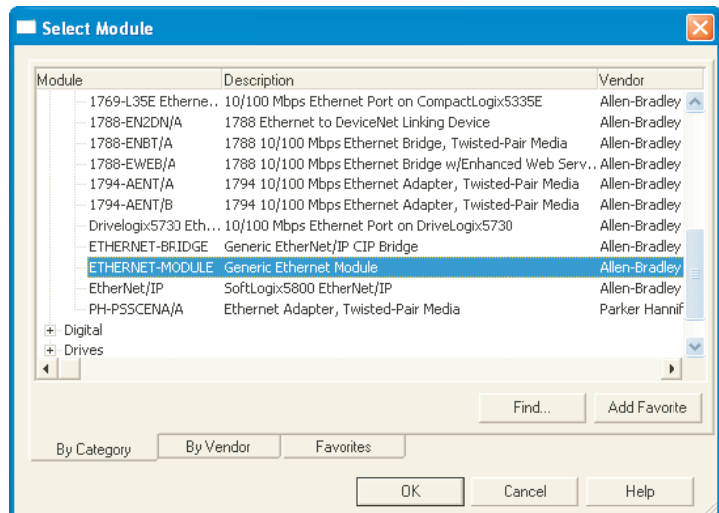

- In the New Module page that appears (Figure 10-12), enter a name for the module, and set Connection Parameter values:

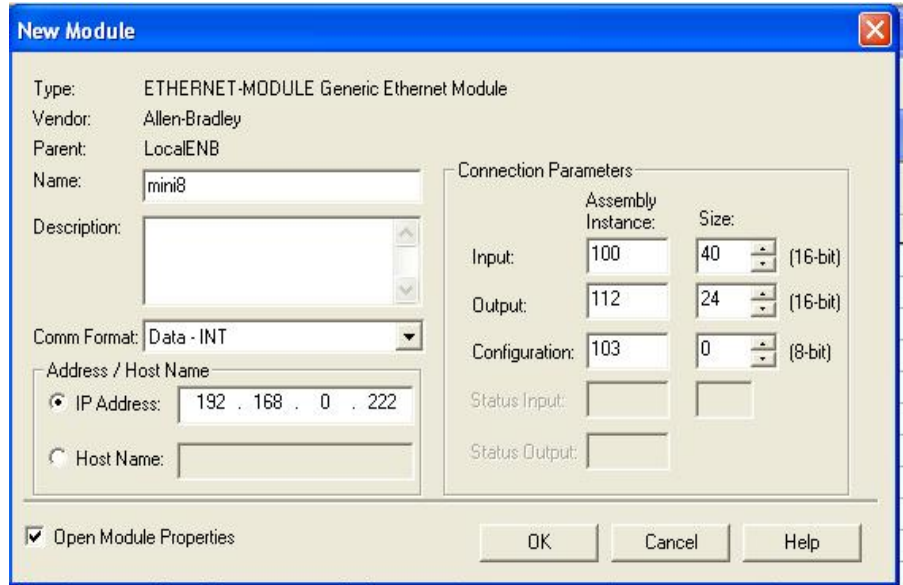

Figure 10-12: New Module

Enter data for the mini8 controller as follows:-

- Select the Comm Format first as: Data - INT - the Size is then defined as a 16-bit number. Note, this box is greyed when once the module has been established.
- Address/Host name: The IP address of the mini8 controller (this can be found in iTools, Comms menu → IP address).
- Input: 100; Size: 40 (see Note 1)
- Output: 112; Size: 24 (see Note 1)
(Size MUST match the Input Output definitions shown in iTools Comms menu)
- Configuration: 103; Size 0 (see Note 1)
- Tick (click on) the 'Open Module Properties' checkbox if it is not already ticked.
- Click on 'OK'

The 'Module Properties' window is now shown (Figure 10-13).

Set the Requested Packet Interval (RPI) to 1000 (1 second) and click 'OK'.

See also section 10.11.6.

Figure 10-13: Module Properties

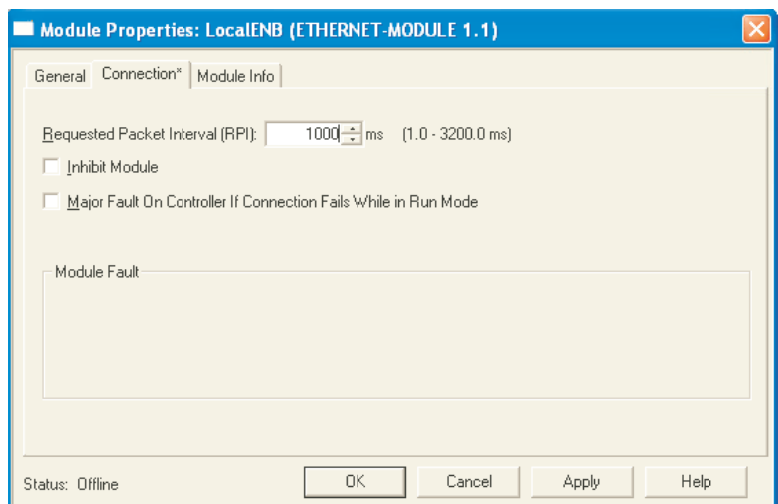

At this point the PLC is configured.

It is then necessary to create or load a pre-determined application for the mini8 controller application using iTools, go to section 10.12.6.

NOTE 1:-

This note shows how the above values can be found using the EZ-EDS tool, as follows:-.

The Connection Parameters are fixed for a Mini8 controller, but may be found from the EDS file relevant to the Mini8 controller in use. The figure below shows an example of the EDS file for the Input Assembly Instance. Click Create/Decode Path button to show the 'Path' pop up window. The instance is shown in Hex as 64. Note: in the New Module selection (Figure 10-2) it is entered in decimal as 100.

A similar page is available for the Output Assembly Instance.

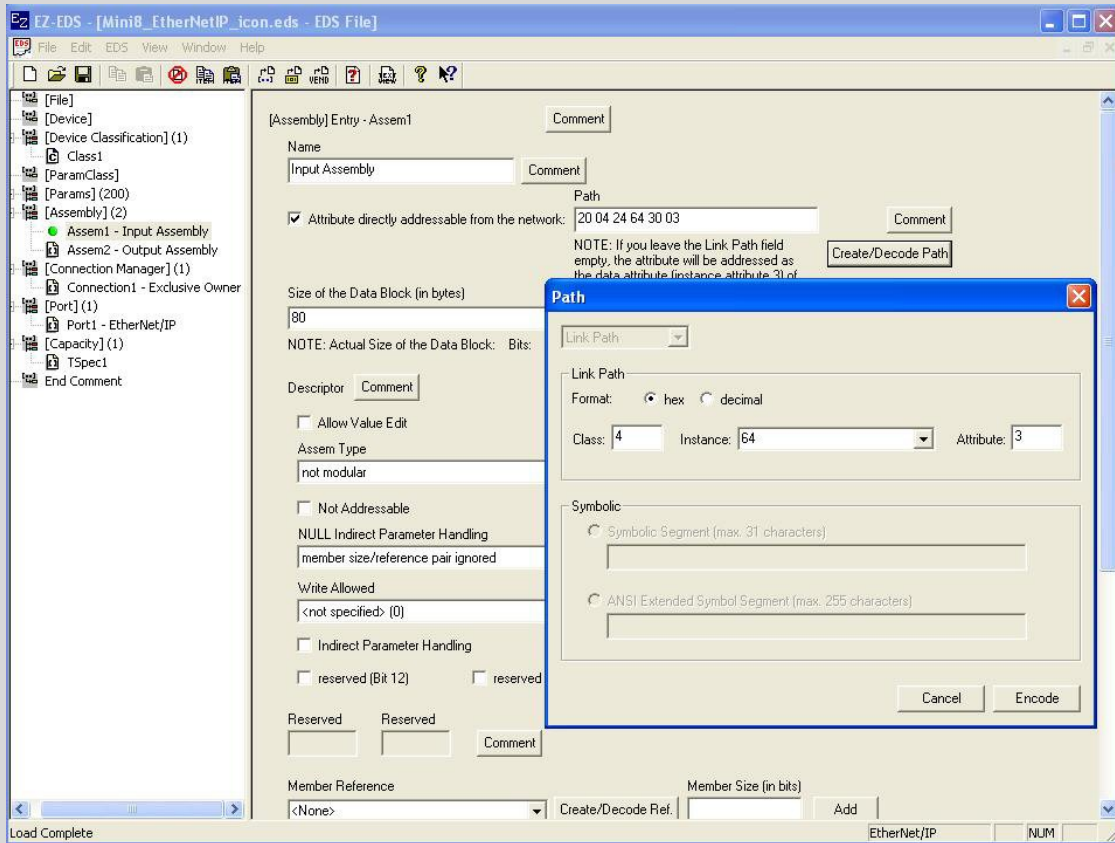

Figure 10-14: EZ-EDS

10.12.6 Create or Load a Mini8 Controller Configuration

1. Ensure an EtherNet/IP comms module is fitted and recognized by the instrument.
2. Configure the mini8 controller using iTools. In the example below the all 8 loops in the mini8 controller slave have been setup for temperature control as shown for Loop 1 in the iTools Graphical Wiring (Figure 10-15).

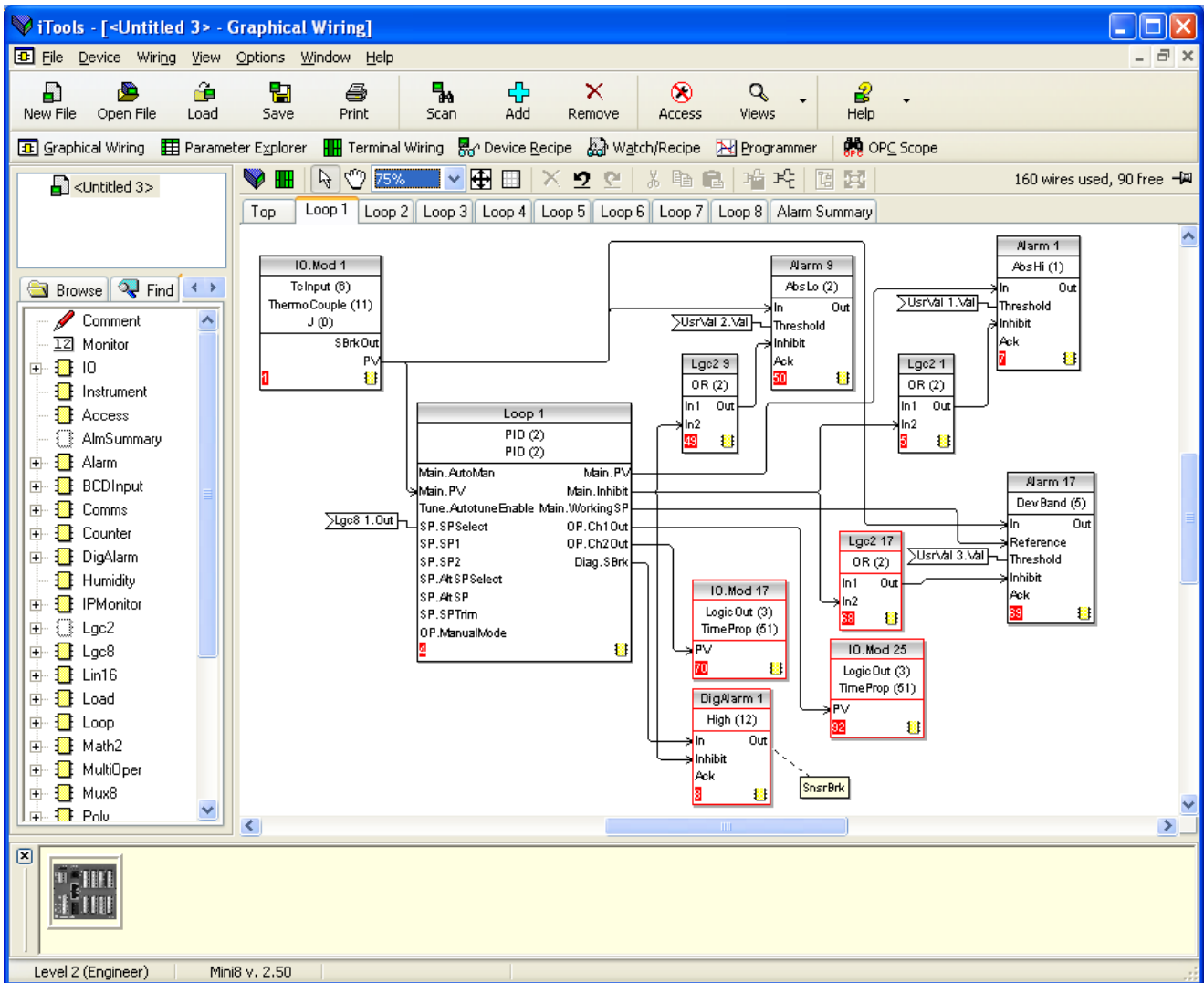

Figure 10-15: Mini8 Controller Graphical Wiring

10.12.7 Run Mode

1. Set the PLC into either 'Remote' or 'Run' mode. This can be done using the key switch on the PLC or in the RSLogix5000 menu.
2. Set the PLC online.

At this point you may be asked to download the file if it is different

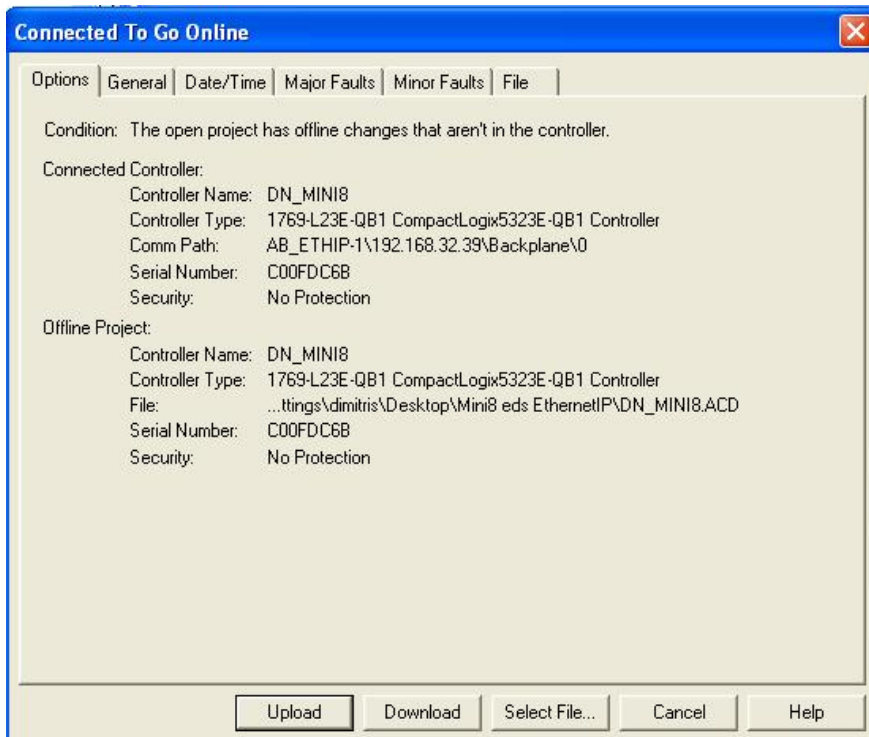

Figure 10-16: Go online

10.12.8 Monitor Parameters

It is possible to check that the PLC is communicating with the mini8 controller using the 'Tags' display to write values to the mini8 controller and to receive values from it. Once it is proved that the link is working, the pc may be disconnected from the PLC.

1. In the left pane tree-view of the RSLogix 5000 window, double click on the Controller Tags symbol.
2. Set the PLC online
3. Expand the Name list (click on the + symbol) to view parameter values. Some non zero values should appear next to input data

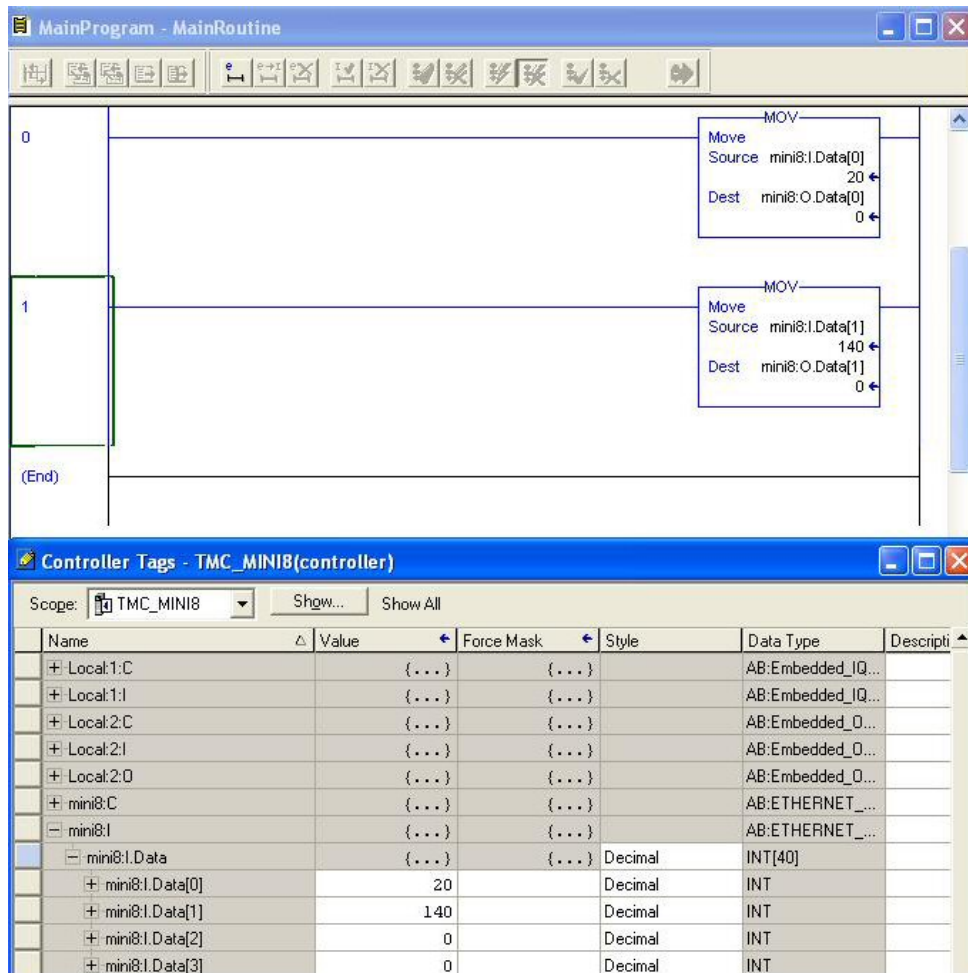

Figure 10-17: Monitor Inputs and Outputs via Controller Tags

10.12.9 Status Indicators

The status indicators at the top left corner of the RSLogix 5000 Page show the status of the link between the pc and the PLC.

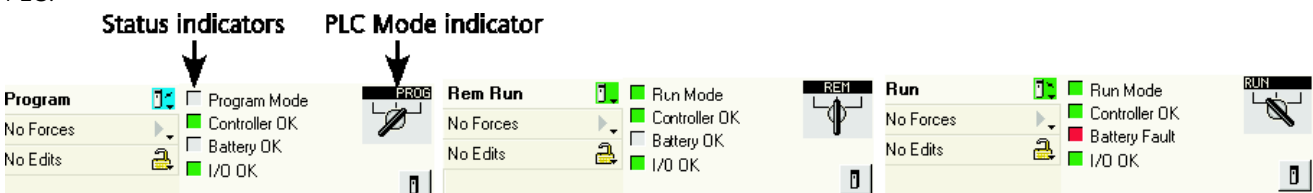

Figure 10-18: Status Indicators

10.12.10 Mini8 Controller on an Ethernet/IP Network

To obtain a graphical representation of the network configuration (if required) proceed as follows:

1. Start the RSNetWorx for EtherNet/IP program (from 'Start/All programs/.../RSNetWorx for EtherNet/IP).
2. In the 'Tools' menu select EDS Wizard.
3. Locate the EDS file in the Hardware list. In the Vendor list select InvensysEurothermMini8 and register the mini8 controller EDS file and icon. The EDS file is available from Eurotherm. After successful registration, an entry will appear in the Generic Device list.
4. Drag and Drop devices from the registered Hardware list to create your network. Figure 10-19 shows an example of two mini8 controllers on a network together with a nanodac controller.

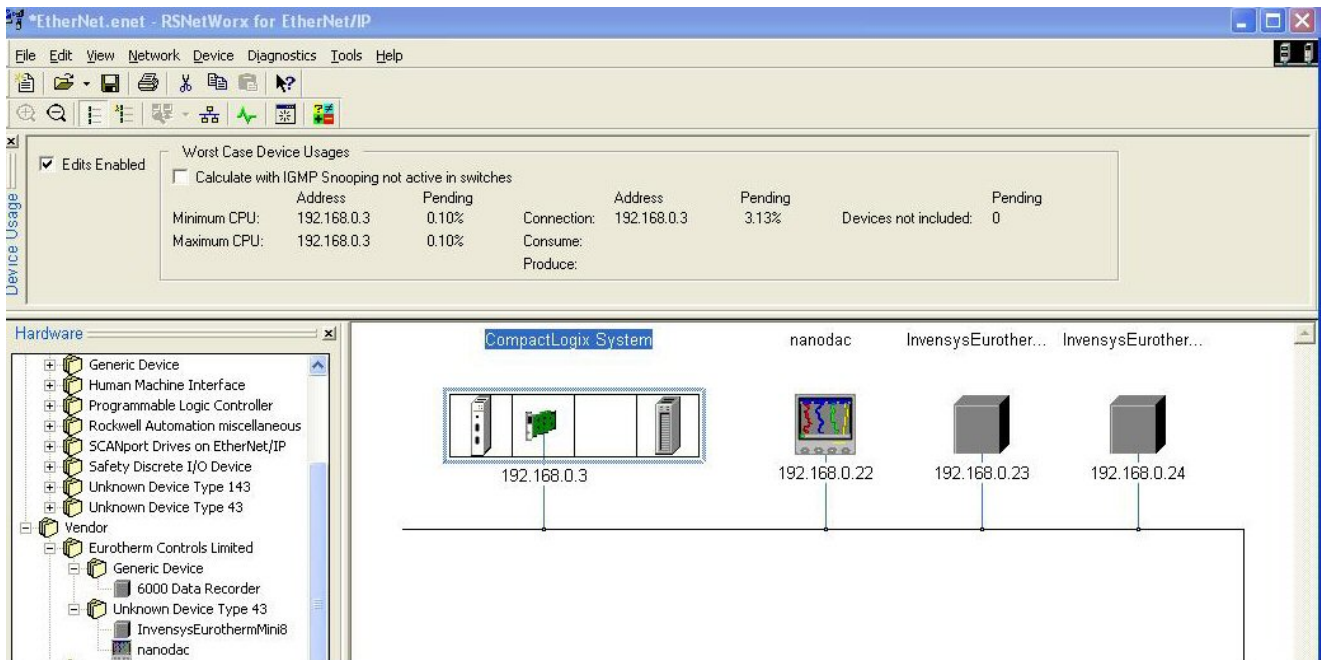
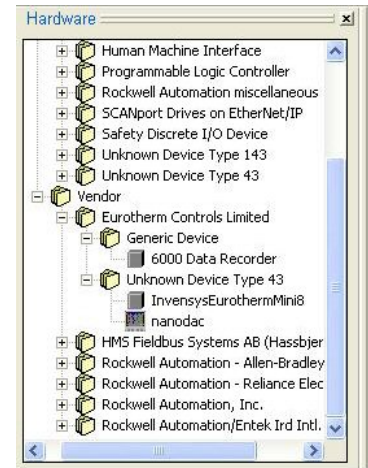

Figure 10-19: Example of Eurotherm Products on an EtherNet/IP Network

Implicit (Cyclic) Messaging

Using the RSLogix 5000, the user can write a Ladder program to read (get) and write (set) Implicit (Cyclic) messages between the PLC master and mini8 controller slave.

Explicit (Acyclic) Messaging

Using the RSNetWorx for EtherNet/IP, in the 'Device' menu, select Class Instance Editor, to read (get) and write (set) Explicit (Acyclic) messages to the mini8 controller. The target controller MUST be selected.

10.12.11 TROUBLESHOOTING

1. Ensure Instruments are Powered On and Online and the PLC is set to RUN mode.
2. Ensure no error Indicators are active on instrument(s)
3. Ensure an EtherNet/IP comms module is fitted and recognized by the instrument
4. Ensure all instruments have unique EtherNet/IP addresses.
5. Ensure subnet Mask is not prohibiting connections.
6. Ensure Input and Output Size of EtherNet Module match exactly the Input and output Definitions (see Figure 10-12 New Module).
7. Ensure Assembly Instance values are supported by the mini8 controller (see Figure 10-12 New Module)
8. Ensure EtherNet cables are not disconnected or damaged.
9. Use PING command from a PC with a similar EtherNet/IP address to verify instrument is responding.
10. Ensure any user program running on PLC is not performing illegal operations.

11. Chapter 11 Counters, Timers, Totalisers, RT Clock

A series of function blocks are available which are based on time/date information. These may be used as part of the control process.

11.1 Counters

Up to two counters are available. They provide a synchronous edge triggered event counter.

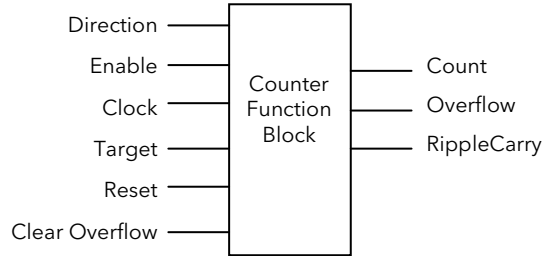

Figure 11-1: Counter Function Block

When configured as an Up counter, Clock events increment Count until reaching the Target. On reaching Target RippleCarry is set true. At the next clock pulse, Count returns to zero. Overflow is latched true and RippleCarry is returned false.

When configured as a down counter, Clock events decrement Count until it reaches zero. On reaching zero RippleCarry is set true. At the next clock pulse, Count returns to the Target count. Overflow is latched true and RippleCarry is reset false.

Counter blocks can be cascaded as shown in the diagram below

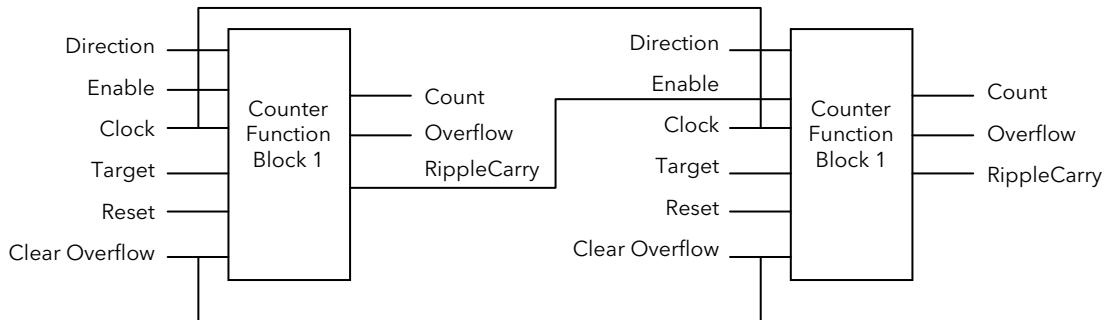

Figure 11-2: Cascading Counters

The RippleCarry output of one counter acts as an enabling input for the next counter. In this respect the next counter in sequence can only detect a clock edge if it was enabled on the previous clock edge. This means that the Carry output from a counter must lead its Overflow output by one clock cycle. The Carry output is, therefore, called a RippleCarry as it is NOT generated on an Overflow (i.e. $\text{Count} \geq \text{Target}$) but rather when the count reaches the target (i.e. $\text{Count} = \text{Target}$). The timing diagram below illustrates the principle for the Up Counter.

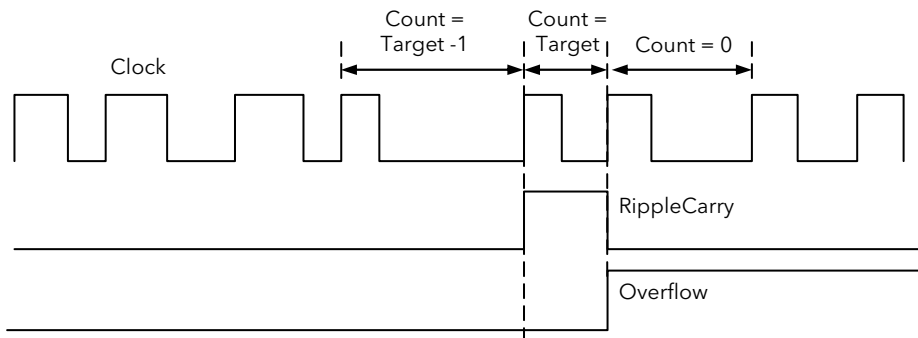

Figure 11-3: Timing Diagram for an Up Counter

11.1.1 Counter Parameters

Folder - Counter		Sub-folders: 1 to 2			
Name	Parameter Description	Value		Default	Access Level
Enable	Counter enable. Counter 1 or 2 is enabled in the Instrument Options folder but they can also be turned on or off in this list	Yes No	Enabled Disabled	No	Oper
Direction	Defines count up or count down. This is not intended for dynamic operation (i.e. subject to change during counting). It can only be set in configuration level.	Up Down	Up counter Down counter	Up	Conf
Ripple Carry	Ripple carry to act as an enabling input to the next counter. It is turned On when the counter reaches the target set	Off			R/O
Overflow	Overflow flag is turned on when the counter reaches zero				R/O
Clock	Tick period to increment or decrement the count. This is normally wired to an input source such as a digital input.	0 1	No clock input Clock input present	0	R/O if wired
Target	Level to which the counter is aiming	0 to 99999		9999	Oper
Count	Counts each time a clock input occurs until the target is reached.	0 to 99999			R/O
Reset	Resets the counter	No Yes	Not in reset Reset	No	Oper
Clear Overflow	Clear overflow flag	No Yes	Not cleared Cleared	No	Oper

11.2 Timers

Up to eight timers can be configured. Each one can be configured to a different type and can operate independently of one another.

11.2.1 Timer Types

Each timer block can be configured to operate in four different modes. These modes are explained below

11.2.2 On Pulse Timer Mode

This timer is used to generate a fixed length pulse from an edge trigger.

- The output is set to On when the input changes from Off to On.
- The output remains On until the time has elapsed
- If the 'Trigger' input parameter recurs while the Output is On, the Elapsed Time will reset to zero and the Output will remain On
- The triggered variable will follow the state of the output

The diagram illustrates the behaviour of the timer under different input conditions.

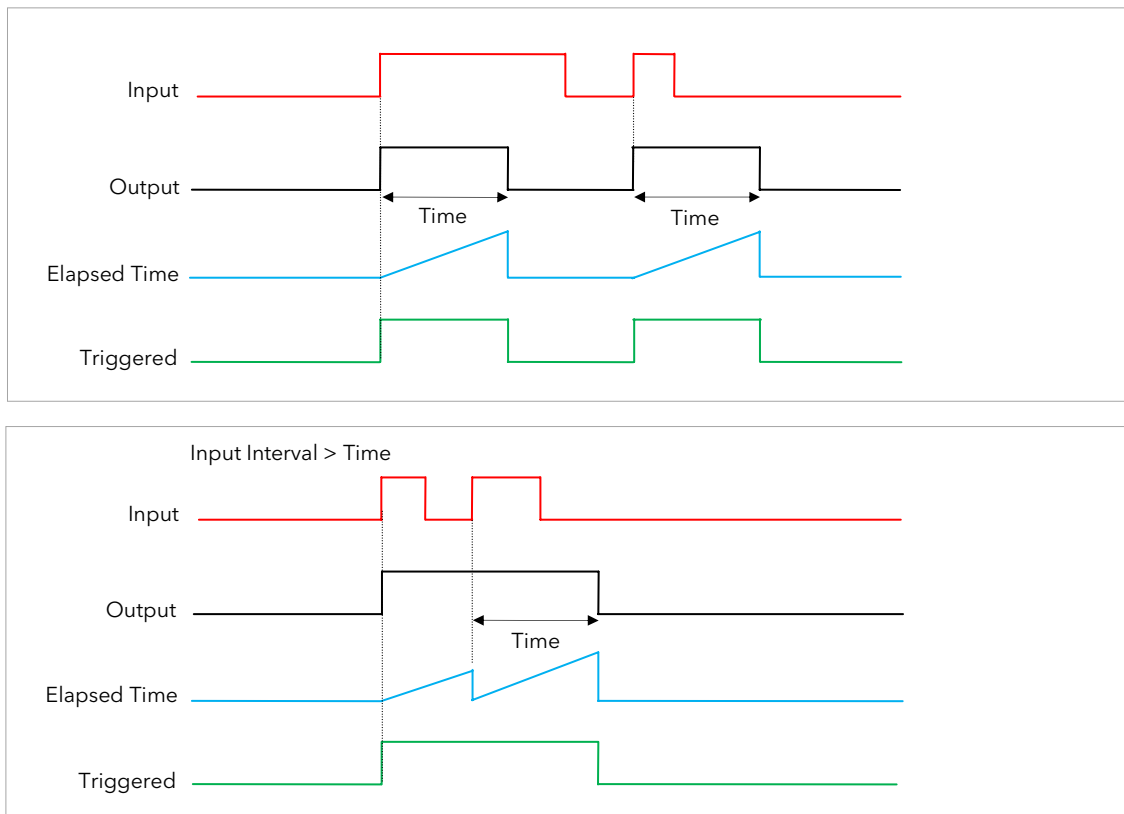

Figure 11-4: On Pulse Timer Under Different Input Conditions

11.2.3 On Delay Timer Mode

This timer provides a delay between the trigger event and the Timer output. If the input pulse is less than the set delay time there is no output pulse.

- The Output is set to Off when the Input changes from Off to On.
- The Output remains Off until the Time has elapsed.
- If the Input returns to Off before the time has elapsed, the Timer will cease and there will be no output.
- If the Input remains on until the Time has elapsed, the Output will be set to On.
- The Output will remain On until the Input is cleared to Off.
- The Triggered variable will be set to On by the Input changing from Off to On. It will remain On until both the Time has elapsed and the Output has reset to Off.

The diagram illustrates the behaviour of the timer under different input conditions.

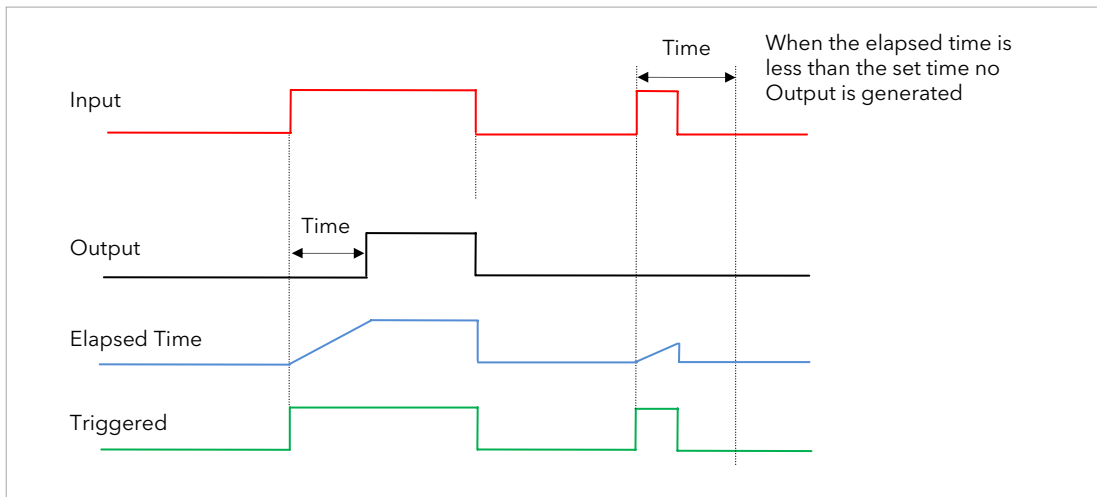

Figure 11-5: On Delay Timer under Different Input Conditions

This type of timer is used to ensure that the output is not set unless the input has been valid for a pre-determined period of time, thus acting as a kind of input filter.

11.2.4 One Shot Timer Mode

This timer behaves like a simple oven timer.

- When the Time is edited to a non-zero value the Output is set to On
- The Time value is decremented until it reaches zero. The Output is then cleared to Off
- The Time value can be edited at any point to increase or decrease the duration of the On time
- Once set to zero, the Time is not reset to a previous value, it must be edited by the operator to start the next On-Time
- The Input is used to gate the Output. If the Input is set, the time will count down to zero. If the Input is cleared to Off, then the Time will hold and the Output will switch Off until the Input is next set.

Note: since the Input is a digital wire, it is possible for the operator to NOT wire it, and set the Input value to On which permanently enables the timer.

- The Triggered variable will be set to On as soon as the Time is edited. It will reset when the Output is cleared to Off.

The behaviour of the timer under different input conditions is shown below.

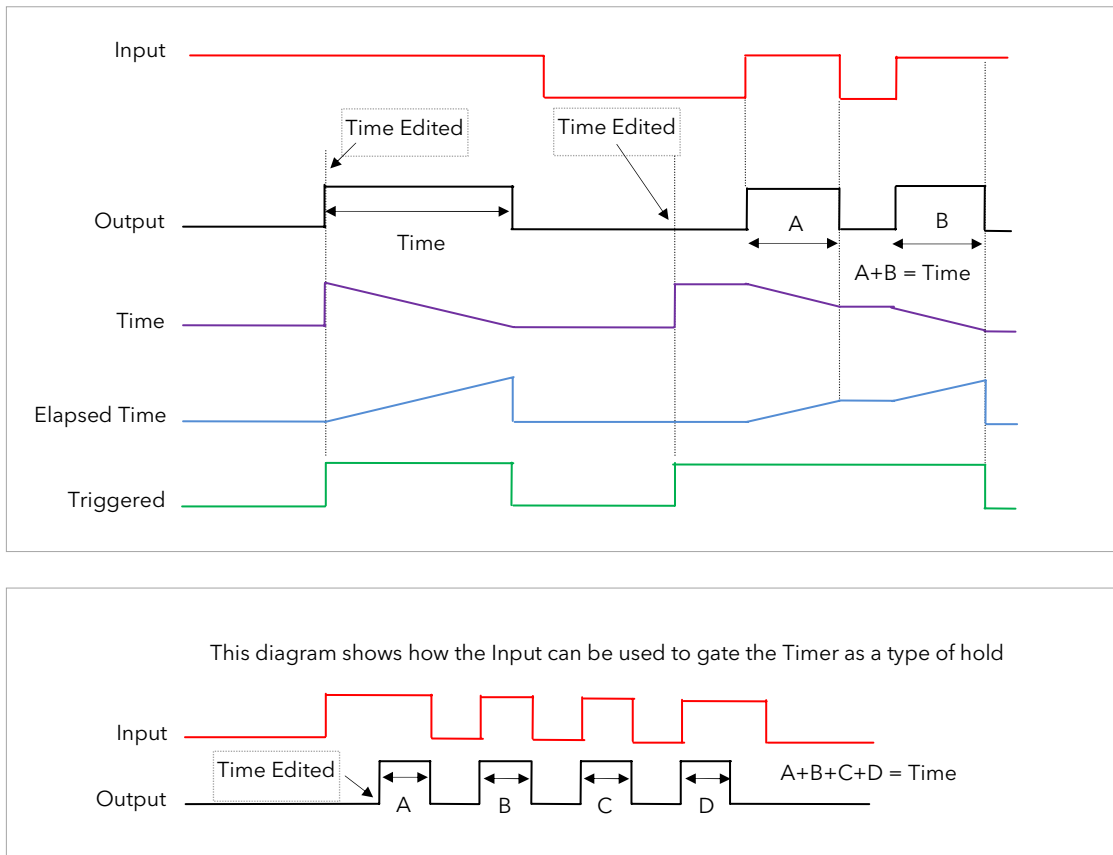

Figure 11-6: One Shot Timer

11.2.5 Minimum On Timer or Compressor Mode

This type of timer may also be known as an 'Off Delay' function where the output goes 'on' when the input goes active and remains on for a specified period after the input goes inactive.

It may be used, for example, to ensure that a compressor is not cycled excessively.

- The output will be set to On when the Input changes from Off to On.
- When the Input changes from On to Off, the elapsed time will start incrementing towards the set Time.
- The Output will remain On until the elapsed time has reached the set Time. The Output will then switch Off.
- If the Input signal returns to On while the Output is On, the elapsed time will reset to 0, ready to begin incrementing when the Input switches Off.
- The Triggered variable will be set while the elapsed time is >0 . It will indicate that the timer is counting.

The diagram illustrates the behaviour of the timer under different input conditions.

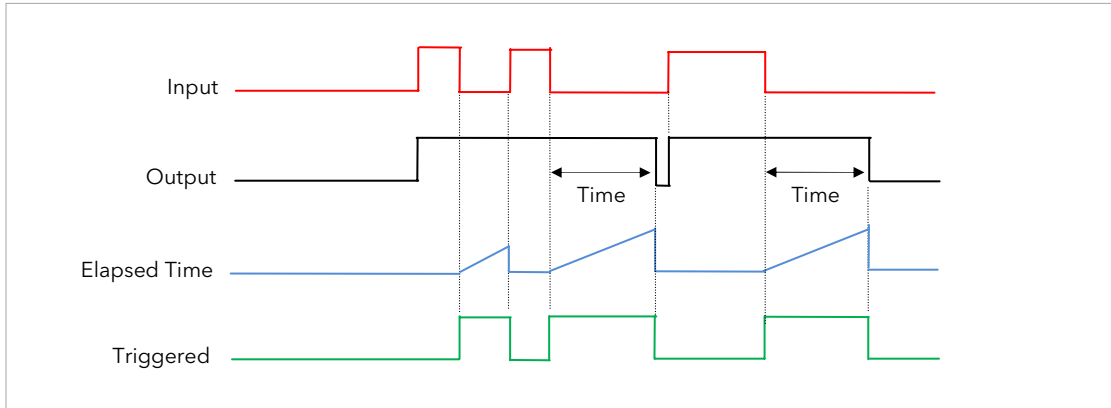

Figure 11-7: Minimum On Timer Under Different Input Conditions

11.2.6 Timer Parameters

Folder - Timer		Sub-folders: 1 to 4			
Name	Parameter Description	Value		Default	Access Level
Type	Timer type	Off	Timer not configured	Off	Conf
		On Pulse	Generates a fixed length pulse from an edge trigger		
		Off Delay	Provides a delay between input trigger event and timer putput		
		One Shot	Simple oven timer which reduces to zero before switching off		
		Min-On Ti	Compressor timer guaranteeing that the output remains ON for a time after the input signal has been removed		
Time	Duration of the timer. For re-trigger timers this value is entered once and copied to the time remaining parameter whenever the timer starts. For pulse timers the time value itself is decremented.	0:00.0 to 99:59:59		0:00.0	Oper
Elapsed Time	Timer elapsed time	0:00.0 to 99:59:59			R/O
In	Trigger/Gate input. Turn On to start timing	Off On	Off Start timing	Off	Oper
Out	Timer output	Off On	Output off Timer has timed out		R/O
Triggered	Timer triggered (timing). This is a status output to indicate that the timers input has been detected	Off On	Not timing Timer timing		R/O

The above table is repeated for Timers 2 to 4.

11.3 Totalisers

There are two totaliser function blocks which are used to measure the total quantity of a measurement integrated over time. A totaliser can, by soft wiring, be connected to any measured value. The outputs from the totaliser are its integrated value and an alarm state. The user may set a setpoint which causes the alarm to activate once the integration exceeds the setpoint.

The totaliser has the following attributes:-

1. Run/Hold/Reset

In Run the totaliser will integrate its input and continuously test against an alarm setpoint.

In Hold the totaliser will stop integrating its input but will continue to test for alarm conditions.

In Reset the totaliser will be zeroed, and alarms will be reset.

2. Alarm Setpoint

If the setpoint is a positive number, the alarm will activate when the total is greater than the setpoint.

If the setpoint is a negative number, the alarm will activate when the total is lower (more negative) than the setpoint.

If the totaliser alarm setpoint is set to 0.0, the alarm will be off. It will not detect values above or below.

The alarm output is a single state output. It may be cleared by resetting the totaliser, or by changing the alarm setpoint.

3. Limits

The total is limited to a maximum of 9,999,999,999 and a minimum of -9,999,999,999.

4. Resolution

The totaliser ensures that resolution is maintained when integrating small values onto a large total.

11.3.1 Totaliser Parameters

Folder - Total		Sub-Folders: 1 to 2			
Name	Parameter Description	Value		Default	Access Level
TotalOut	The totalised value	±9,999,999,999			R/O
In	The value to be totalised	-9999.9 to 9999.9. Note:- the totaliser stops accumulating if the input is 'Bad'.			Oper
Units	Totaliser units	None AbsTemp V, mV, A, mA, PH, mmHg, psi, Bar, mBar, %RH, %, mmWG, inWG, inWW, Ohms, PSIG, %O2, PPM, %CO2, %CP, %/sec, RelTemp mBar/Pa/T sec, min, hrs,			Conf
Resolution	Totaliser resolution	XXXXX XXXX.X XXX.XX XX.XXX X.XXXX		XXXXX	Conf
Alarm SP	Sets the totalised value at which an alarm will occur	±9,999,999,999			Oper
AlarmOut	This is a read only value which indicates the alarm output On or Off. The totalised value can be a positive number or a negative number. If the number is positive the alarm occurs when Total > + Alarm Setpoint If the number is negative the alarm occurs when Total > - Alarm Setpoint	Off On	Alarm inactive Alarm output active	Off	Oper
Run	Runs the totaliser	No Yes	Totaliser not running Select Yes to run the totaliser	No	Oper
Hold	Holds the totaliser at its current value Note: The Run & Hold parameters are designed to be wired to (for example) digital inputs. Run must be 'on' and Hold must be 'off' for the totaliser to operate.	No Yes	Totaliser not in hold Hold totaliser	No	Oper
Reset	Resets the totaliser	No Yes	Totaliser not in reset Totaliser in reset	No	Oper

11.4 Real Time Clock

A real time clock (day of week and time only) is used to provide a daily and weekly scheduling facility and provides two corresponding outputs. The configuration for an output is an On-Day and an On-Time and an Off-Day and an Off-Time. The Real Time Clock also provides the time stamping in the AlarmLog (Section 8.8).

The day options supported are:-

Day Option	Description
Never	Disables the output feature
Monday	Output will only be available on a Monday
Tuesday	Output will only be available on a Tuesday
Wednesday	Output will only be available on a Wednesday
Thursday	Output will only be available on a Thursday
Friday	Output will only be available on a Friday
Saturday	Output will only be available on a Saturday
Sunday	Output will only be available on a Sunday
Mon-Fri	Output will only be available between Monday to Friday
Mon-Sat	Output will only be available on between Monday to Saturday
Sat-Sun	Output will only be available on between Saturday to Sunday
Everyday	Output always available

For example, it is possible to configure an output to be activated at 07:30 on Monday and deactivated at 17:15 on Friday

The output from the Real Time Clock outputs may be used to place the instrument in standby or to sequence a batch process.

The Real Time Clock function will set/clear the outputs only at the configured time. Therefore it is possible to override the outputs manually, by editing the output to On/Off between output activations.

The Real Time Clock does not display date or year.

11.4.1 Real Time Clock Parameters

Folder - RTClock		Sub Folders: None			
Name	Parameter Description	Value		Default	Access Level
Mode	This parameter can be used to set the clock	Running	Normal operation	Stopped	Oper
		Edit	Allows the clock to be set		
		Stopped	Clock stopped (saves battery life)		
Day	Displays the day or allows the day to be set when in Edit mode	Monday to Sunday			Oper
Time	Displays the time or allows the time to be set when in Edit mode	00:00:00 to 23:59:59			Oper
On Day1 On Day2	Days when output 1 and 2 are activated	See table above			Oper
On Time1 On Time2	Time of day when output 1 and 2 are activated	00:00:00 to 23:59:59			Oper
Off Day1 Off Day2	Days when output 1 and 2 are de-activated	See table above			Oper
Off Time1 Off Time2	Time of day when output 1 and 2 are de-activated	00:00:00 to 23:59:59			Oper
Out1 Out2	Output 1 and 2	Off On	Output not activated Output activated		Oper

12. Chapter 12 Applications

12.1 Humidity

12.1.1 Overview

Humidity (and altitude) control is a standard feature of the Mini8 controller. In these applications the controller may be configured to generate a setpoint profile (see Section 0 'Setpoint Programmer').

Also the controller may be configured to measure humidity using either the traditional Wet/Dry bulb method or it may be interfaced to a solid state sensor.

The controller output may be configured to turn a refrigeration compressor on and off, operate a bypass valve, and possibly operate two stages of heating and/or cooling

12.1.2 Temperature Control of an Environmental Chamber

The temperature of an environmental chamber is controlled as a single loop with two control outputs. The heating output time proportions electric heaters, usually via a solid state relay. The cooling output operates a refrigerant valve which introduces cooling into the chamber. The controller automatically calculates when heating or cooling is required.

12.1.3 Humidity Control of an Environmental Chamber

Humidity in a chamber is controlled by adding or removing water vapour. Like the temperature control loop two control outputs are required, i.e. Humidify and Dehumidify.

To humidify the chamber water vapour may be added by a boiler, an evaporating pan or by direct injection of atomised water.

If a boiler is being used adding steam increases the humidity level. The humidify output from the controller regulates the amount of steam from the boiler that is allowed into the chamber.

An evaporating pan is a pan of water warmed by a heater. The humidify output from the controller humidity regulates the temperature of the water.

An atomisation system uses compressed air to spray water vapour directly into the chamber. The humidify output of the controller turns on or off a solenoid valve.

Dehumidification may be accomplished by using the same compressor used for cooling the chamber. The dehumidify output from the controller may control a separate control valve connected to a set of heat exchanger coils.

12.1.4 Humidity Parameters

List Folder - Humidity		Sub-folder: None			
Name	Parameter Description	Value		Default	Access Level
Resolution	Resolution of the relative humidity	XXXXX XXXX.X XXX.XX XX.XXX X.XXXX			Conf
Psychro Const	The psychrometric constant at a given pressure (6.66E-4 at standard atmospheric pressure). The value is dependent on the speed of air-flow across the wet bulb, and hence the rate of evaporation. 6.66E-4 is for the ASSMANN ventilated Psychrometer.	0.0 to 10.0		6.66	Oper
Pressure	Atmospheric Pressure	0.0 to 2000.0		1013.0 mbar	Oper
WetTemp	Wet Bulb Temperature	Range units			
WetOffset	Wet bulb temperature offset	-100.0 to 100.0		0.0	Oper
DryTemp	Dry Bulb Temperature	Range units			
RelHumid	Relative Humidity is the ratio of actual water vapour pressure (AVP) to the saturated water vapour pressure (SVP) at a particular temperature and pressure	0.0 to 100.0		100	R/O
DewPoint	The dew point is the temperature to which air would need to cool (at constant pressure and water vapour content) in order to reach saturation	-999.9 to 999.9			R/O
Sbrk	Indicates that one of the probes is broken.	No Yes	No sensor break detection Sensor break detection enabled		Conf

12.2 Zirconia (Carbon Potential) Control

A Mini8 Controller has a Zirconia function block which may be used to control Carbon potential. The controller is often a programmer which generates carbon potential profiles. In this section it is assumed that a programmer is used.

Calculation of PV: The Process Variable can be Carbon Potential, Dewpoint or Oxygen concentration. The PV is derived from the probe temperature input, the probe mV input and remote gas reference input values. Various probe makes are supported. In the Mini8 Controller Carbon Potential and Dewpoint can be displayed together.

The following definitions may be useful:-

12.2.1 Temperature Control

The sensor input of the temperature loop may come from the zirconia probe but it is common for a separate thermocouple to be used. The controller provides a heating output which may be connected to gas burners or thyristors to control electrical heating elements. In some applications a cooling output may also be connected to a circulation fan or exhaust damper.

12.2.2 Carbon Potential Control

The zirconia probe generates a millivolt signal based on the ratio of oxygen concentrations on the reference side of the probe (outside the furnace) to the amount of oxygen in the furnace.

The controller uses the temperature and carbon potential signals to calculate the actual percentage of carbon in the furnace. This second loop generally has two outputs. One output is connected to a valve which controls the amount of an enrichment gas supplied to the furnace. The second output controls the level of dilution air.

12.2.3 Sooting Alarm

In addition to other alarms which may be detected by the controller, the Mini8 Controller can trigger an alarm when the atmospheric conditions are such that carbon will be deposited as soot on all surfaces inside the furnace. The alarm may be connected to an output (e.g. relay) to initiate an external alarm.

12.2.4 Automatic Probe Cleaning

The Zirconia function block has a probe clean and recovery strategy that can be programmed to occur between batches or manually requested. At the start of the cleaning process a 'snapshot' of the probe mV is taken, and a short blast of compressed air is used to remove any soot and other particles that may have accumulated on the probe. A minimum and maximum cleaning time can be set by the user. If the probe mV has not recovered to within 5% of the snapshot value within the maximum recovery time set then an alarm is given. This indicates that the probe is ageing and replacement or refurbishment is due. During the cleaning and recovery cycle the PV is frozen, thereby ensuring continuous furnace operation. A flag 'PvFrozen' is set which can be used in an individual strategy, for example to hold the integral action during cleaning.

12.2.5 Endothermic Gas Correction

A gas analyser may be used to determine the CO concentration of the endothermic gas. If a 4-20mA output is available from the analyser, it can be fed into the Mini8 Controller to automatically adjust the calculated % carbon reading. Alternatively, this value can be entered manually.

12.2.6 Clean Probe

As these sensors are used in furnace environments they require regular cleaning. Cleaning (Burn Off) is performed by forcing compressed air through the probe. Cleaning can be initiated either manually or automatically using a timed period. During cleaning the PV output is frozen.

12.2.7 Probe Status

After cleaning an alarm output, MinCalcT, is generated if the PV does not return to 95% of its previous value within a specified time. This indicates that the probe is deteriorating and should be replaced.

12.2.8 Zirconia Parameters

Folder - Zirconia		Sub-folders: None			
Name	Parameter Description	Value		Default	Access Level
Probe Type	Configures the type of probe to be used	Drayton Accucarb SSI MacDhui %O2 LogO2 BoschO2 ZircoDew ProbeMV BoschCarb BarberC MMICarb AACC	Drayton Accucarb SSI MacDhui Oxygen Log Oxygen Bosch Oxygen Dewpoint. Probe mV Bosch Carbon Barber-Colman MMI Carbon AACC		Op
Resolution	Resolution of the calculated result	X X.X X.XXX X.XXX X.XXXX		X	Op
Parameters shown in shaded rows below are not applicable to O2 probes					
GasRef	Gas reference value	-9999.9 to 9999.9		20.0	Op
RemGasRef	Remote gas reference value	-9999.9 to 9999.9		0.0	Op
RemGasEn	Enable the remote gas reference. This can be an internal value from the user interface or from an external source	0 1	Internal External	0	Op
MinCalTemp	Minimum calculation temperature	-99999 to 99999		720	Op
OxygenExp	The exponent units of the log oxygen type calculation				
Tolerance	Tolerance of the sooting	-9999.9 to 9999.9		1.0	Op
CleanFreq	Frequency of the cleaning process	0:00:00 to 99:59:59 or 100:00 to 500:00		4:00:00	Op
CleanTime	Sets the duration of the clean	0:00:00 to 99:59:59 or 100:00 to 500:00		0:00:00	Op
MinRcovTime	Minimum recovery time after purging	0:00:00 to 99:59:59 or 100:00 to 500:00		0:00:00	Op
MaxRcovTime	Maximum recovery time after purging	0:00:00 to 99:59:59 or 100:00 to 500:00		0:10:00	Op
TempInput	Zirconia probe temperature input value	Temp range			Op
TempOffset	Sets a temperature offset for the probe	-99999 to 99999		0	Op
ProbeInput	Zirconia probe mV input				Op
ProbeOffset	Zirconia probe mV offset	-99999 to 99999		0	Op
Oxygen	Calculated oxygen			0	
CarbonPot	Calculated carbon potential			0	R/O
DewPoint	Zirconia control process value The O2 or dew point value derived from temperature and remote gas reference inputs			0	R/O
SootAlm	Probe sooting alarm output	No Yes	No alarm output In alarm	No	R/O
ProbeFault	Probe fault	No Yes		No	Op
PvFrozen	This is a Boolean which freezes the PV during a purging cycle. It may have been wired, for example, to disable control output during purging	No Yes		No	R/O
CleanValve	Enable the clean valve.	No Yes		No	R/O

Folder - Zirconia		Sub-folders: None			
Name	Parameter Description	Value		Default	Access Level
CleanState	The burn off state of the zirconia probe	Waiting Cleaning Recovering			R/O
CleanProbe	Enable clean probe. This may be wired to initiate automatically or if un-wired can be set by the user	No Yes	Do not clean probe Initiate probe clean	No	Op
Time2Clean	Time to next clean.	0:00:00 to 99:59:59 or 100:00 to 500:00		0	R/O
ProbeStatus	Indicates the status of the probe.	OK mVSbr TempSbr MinCalcT	Normal working Probe input in sensor break Temperature input in sensor break Probe deteriorating		R/O

13. Chapter 13 Input Monitor

13.1 Description

There are two Input monitors. Each input monitor may be wired to any variable in the controller. It then provides three functions:-

1. Maximum detect
2. Minimum detect
3. Time above threshold

13.1.1 Maximum Detect

This function continuously monitors the input value. If the value is higher than the previously recorded maximum, it becomes the new maximum.

This value is retained following a power fail.

13.1.2 Minimum Detect

This function continuously monitors the input value. If the value is lower than the previously recorded minimum, it becomes the new minimum.

This value is retained following a power fail.

13.1.3 Time Above Threshold

This function increments a timer whenever the input is above a threshold value. If the timer exceeds 24 hours per day, a counter is incremented. The maximum number of days is limited to 255. A time alarm can be set on the timer so that once the input has been above a threshold for a period, an alarm output is given.

Applications include:-

- Service interval alarms. This sets an output when the system has been running for a number of days (up to 255 days)
- Material stress alarms - if the process cannot tolerate being above a level for a period. This is a style of 'policeman' for processes where the high operating point degrades the life of the machine.
- In internal wiring applications in the controller

13.2 Input Monitor Parameters

Folder - IPMonitor		Sub-Folders: 1 or 2			
Name	Parameter Description	Value		Default	Access Level
In	The input value to be monitored	May be wired to an input source. The range will depend on the source			Oper R/O if wired
Max	The maximum measured value recorded since the last reset	As above			R/O
Min	The minimum measured value recorded since the last reset	As above			R/O
Threshold	The input timer accumulates the time the input PV spends above this trigger value.	As above			Oper
Days Above	Accumulated days the input has spent above threshold since the last reset.	Days is an integer count of the 24 hour periods only. The Days value should be combined with the Time value to make the total time above threshold.			R/O
Time Above	Accumulated time above the 'Threshold' since last reset.	The time value accumulates from 00:00.0 to 23:59.9. Overflows are added to the days value			R/O
AlarmDays	Days threshold for the monitors time alarm. Used in combination with the Alarm Time parameter. The 'Out' is set to true if the inputs accumulated time above threshold is higher than the timer high parameters.	0 to 255		0	Oper
AlarmTime	Time threshold for the monitors time alarm. Used in combination with the Alarm Days parameter. The 'Out' is set to true if the inputs accumulated time above threshold is higher than the timer high parameters.	0:00.0 to 99:59:59		0:00.0	Oper
Out	Set true if the accumulated time that the input spends above the trigger value is higher than the alarm threshold.	Off On	Normal operation time above setpoint exceeded		R/O
Reset	Resets the Max and Min values and resets the time above threshold to zero.	No Yes	Normal operation Reset values	No	Oper
In Status	Monitors the status of the input	Good Bad	Normal operation The input may be incorrectly wired		R/O Oper

14. Chapter 14 Logic and Maths Operators.

14.1 Logic Operators

Logic Operators allow the controller to perform logical calculations on **two** input values. These values can be sourced from any available parameter including Analogue Values, User Values and Digital Values.

The parameters to use, the type of calculation to be performed, input value inversion and 'fallback' value are determined in Configuration level.

There are 24 separate calculations - they do not have to be in sequence. When logic operators are enabled a Folder '**Lgc2**' exists where the 2 denotes two input logic operators.

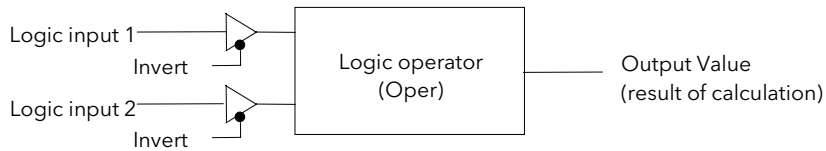

Figure 14-1: 2 Input Logic Operators

Logic Operators are found under the folder '**Lgc2**'. Note that the logic operators can also be enable by dragging a block onto the graphical wiring screen in iTools.

14.1.1 Logic 8

Logic 8 operators can perform logic calculations on up to **eight** inputs. The calculations are limited to AND,OR,XOR. Up to two 8 input operators can be enabled. The folder is labelled '**Lgc8**' to denote eight input logic operators.

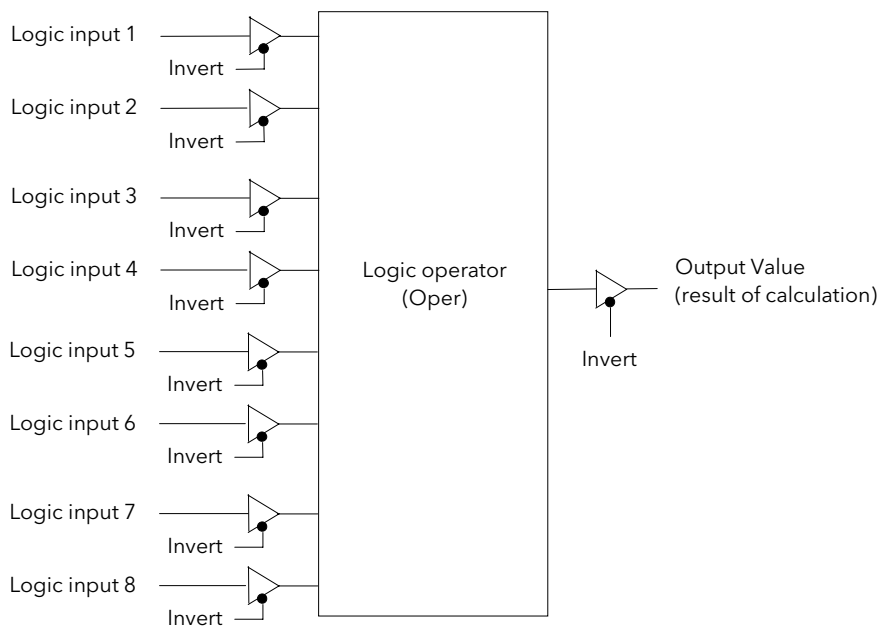

Figure 14-2: 8 Input Logic Operators

14.1.2 2 input Logic Operations

The following calculations can be performed:

Oper	Operator description	Input 1	Input 2	Output Invert = None
0: OFF	The selected logic operator is turned off			
1: AND	The output result is ON when both Input 1 and Input 2 are ON	0	0	Off
		1	0	Off
		0	1	Off
		1	1	On
2: OR	The output result is ON when either Input 1 or Input 2 is ON	0	0	Off
		1	0	On
		0	1	On
		1	1	On
3: XOR	Exclusive OR. The output result is true when one and only one input is ON. If both inputs are ON the output is OFF.	0	0	Off
		1	0	On
		0	1	On
		1	1	Off
4: Latch	Input 1 sets the latch, Input 2 resets the latch.	0	0	
		1	0	
		0	1	
		1	1	
5: Equal (==)	The output result is ON when Input 1 = Input 2	0	0	On
		1	0	Off
		0	1	Off
		1	1	On
6: Not equal (<>)	The output result is ON when Input 1 does not equal Input 2	0	0	Off
		1	0	On
		0	1	On
		1	1	Off
7: Greater than (>)	The output result is ON when Input 1 > Input 2	0	0	Off
		1	0	On
		0	1	Off
		1	1	Off
8: Less than (<)	The output result is ON when Input 1 < Input 2	0	0	Off
		1	0	Off
		0	1	On
		1	1	Off
9: Equal to or Greater than (=>)	The output result is ON when Input 1 ≥ Input 2	0	0	On
		1	0	On
		0	1	Off
		1	1	On
10: Less than or Equal to (<=)	The output result is ON when Input 1 ≤ Input 2	0	0	On
		1	0	Off
		0	1	On
		1	1	On

Note 1: The numerical value is the value of the enumeration

Note 2: For options 1 to 4 an input value of less than 0.5 is considered false and greater than or equal to 0.5 as true.

14.1.3 Logic Operator Parameters

Folder - Lgc2 (2 Input Operators)		Sub-Folders: 1 to 24			
Name	Parameter Description	Value		Default	Access Level
Oper	To select the type of operator	See previous table		None	Conf
In1	Input 1	Normally wired to a logic, analogue or user value. May be set to a constant value if not wired.		0	OPER
In2	Input 2				
FallbackType	The fallback state of the output if one or both of the inputs is bad	0: FalseBad	The output value is FALSE and the status is GOOD.		Conf
		1: TrueBad	The output value is FALSE and the status is BAD		
		2: FalseGood	The output value is TRUE and the status is GOOD		
		3: TrueGood	The output value is TRUE and the status is BAD.		
Invert	The sense of the input value, may be used to invert one or both of the inputs	0: None	Neither input inverted		Conf
		1: Input1	Invert input 1		
		2: Input2	Invert input 2		
		3: Both	Invert both inputs		
Out	The output from the operation is a boolean (true/false) value.	On Off	Output activated Output not activated		R/O
Status	The status of the result value	Good Bad			R/O

14.2 Eight Input Logic Operators

The eight input logic operator may be used to perform the following operations on eight inputs.

Oper	Operator description
0: OFF	The selected logic operator is turned off
1: AND	The output result is ON when ALL eight inputs are ON
2: OR	The output result is ON when one or more of the 8 inputs are ON
3: XOR	Exclusive OR - the output is true if an odd number of inputs are true. $(In1 \oplus In2) \oplus (In3 \oplus In4) \oplus (In5 \oplus In6) \oplus (In7 \oplus In8)$

Eight Input Logic Operator Parameters

Folder - Lgc8 (8 Input Operators)		Sub-Folders: 1 to 4			
Name	Parameter Description	Value		Default	Access Level
Oper	To select the type of operator	0: OFF 1: AND 2: OR 3: XOR	Operator turned off Output ON when all inputs are ON Output ON when one input is ON Exclusive OR	OFF	Conf
NumIn	This parameter is used to configure the number of inputs for the operation	1 to 8		2	Conf
InInvert	Used to invert selected inputs prior to operation. This is a status word with one bit per input, the left hand bit inverts input 1.	The invert parameter is interpreted as a bitfield where: 1 (0x1) - input 1 2 (0x2) - input 2 4 (0x4) - input 3 8 (0x8) - input 4 16 (0x10) - input 5 32 (0x20) - input 6 64 (0x40) - input 7 128 (0x80) - input 8 (e.g. 255 = all eight)		0	Oper
Out Invert	Invert the output	No Yes	Output not inverted Output inverted	No	Oper
In1 to In8	Input state 1 to 8	Normally wired to a logic, analogue or user value. When wired to a floating point, values less than or equal to -0.5 or greater than or equal to 1.5 will be rejected (e.g. the value of the lgc8 block will not change). Values between -0.5 and 1.5 will be interpreted as ON when greater than or equal to 0.5 and OFF when less than 0.5. May be set to a constant value if not wired.		Off	Oper
Out	Output result of the operator	On Off	Output activated Output not activated		R/O

14.3 Maths Operators

Maths Operators (sometimes known as Analogue Operators) allow the controller to perform mathematical operations on two input values. These values can be sourced from any available parameter including Analogue Values, User Values and Digital Values. Each input value can be scaled using a multiplying factor or scalar.

The parameters to use, the type of calculation to be performed and the acceptable limits of the calculation are determined in Configuration level. In normal operation the values of each of the scalars may be changed via communications or iTools.

There are 24 separate calculations - they do not have to be in sequence. When maths operators are enabled (in Instrument/Options folder) a Folder '**Math2**' exists (where the 2 denotes two input maths operators).

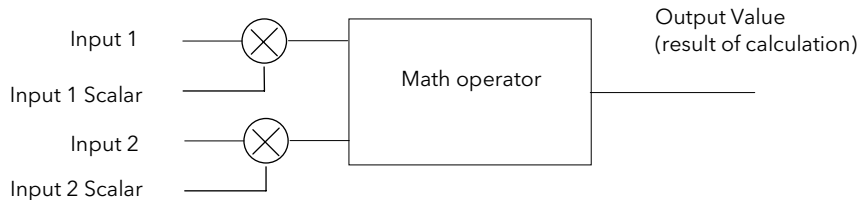

Figure 14-3: 2 Input Math Operators

8 input multiplexers are also available and are described in section 14.5.

14.3.1 Math Operations

The following operations can be performed:

0: Off	The selected analogue operator is turned off
1: Add	The output result is the addition of Input 1 and Input 2
2: Subtract (Sub)	The output result is the difference between Input 1 and Input 2 where Input 1 > Input 2
3: Multiply (Mul)	The output result is the Input 1 multiplied by Input 2
4: Divide (Div)	The output result is Input 1 divided by Input 2
5: Absolute Difference (AbsDif)	The output result is the absolute difference between Input 1 and 2
6: Select Max (SelMax)	The output result is the maximum of Input 1 and Input 2
7: Select Min (SelMin)	The output result is the minimum of Input 1 and Input 2
8: Hot Swap (HotSwp)	Input 1 appears at the output provided input 1 is 'good'. If input 1 is 'bad' then input 2 value will appear at the output. An example of a bad input occurs during a sensor break condition.
9: Sample and Hold (SmpHld)	Normally input 1 will be an analogue value and input B will be digital. The output tracks input 1 when input 2 = 1 (Sample). The output will remain at the current value when input 2 = 0 (Hold). If input 2 is an analogue value then any non zero value will be interpreted as 'Sample'.
10: Power	The output is the value at input 1 raised to the power of the value at input 2. I.e. $input\ 1^{input\ 2}$
11: Square Root (Sqrt)	The output result is the square root of Input 1. Input 2 has no effect.
12: Log	The output is the logarithm (base 10) of Input 1. Input 2 has no effect
13: Ln	The output is the logarithm (base n) of Input 1. Input 2 has no effect
14: Exp	The output result is the exponential of Input 1. Input 2 has no effect
15: 10 x	The output result is 10 raised to the power of Input 1 value. I.e. $10^{input\ 1}$. Input 2 has no effect
51: Select	<p>Select input is used to control which Analogue Input is switched to the output of the Analogue Operator. If the select input is true input 2 is switched through to the output. If false input 1 is switched through to the output. See example below:-</p> <pre> graph TD S[Select input] --> SL[Select Logic 1] I1[An input 1] --> SL I2[An input 2] --> SL SL --> O[An Op 1] SL --- T1[If Select Input = 1, then An input 2 is selected] SL --- T2[If Select Input = 0, then An input 1 is selected] </pre>

When Boolean parameters are used as inputs to analogue wiring, they will be cast to 0.0 or 1.0 as appropriate. Values <= -0.5 or >= 1.5 will not be wired. This provides a way to stop a Boolean updating. Analogue wiring (whether simple re-routing or involving calculations) will always output a real type result, whether the inputs were booleans, integers or reals.

Note: The numerical value is the value of the enumeration

14.3.2 Math Operator Parameters

Folder - Math2 (2 Input Operators)		Sub-Folders: 1 to 24		
Name	Parameter Description	Value	Default	Access Level
Oper	To select the type of operator	See previous table	None	Conf
In1Mul	Scaling factor on input 1	Limited to max float *	1.0	Oper
In2 Mul	Scaling factor on input 2	Limited to max float *	1.0	Oper
Units	Units applicable to the output value	None AbsTemp V, mV, A, mA, PH, mmHg, psi, Bar, mBar, %RH, %, mmWG, inWG, inWW, Ohms, PSIG, %O2, PPM, %CO2, %CP, %/sec, RelTemp mBar/Pa/T sec, min, hrs,	None	Conf
Resolution	Resolution of the output value	XXXXX. XXXX.X, XXX.XX, XX.XXX, X.XXXX		Conf
LowLimit	To apply a low limit to the output	Max float* to High limit (decimal point depends on resolution)		Conf
HighLimit	To apply a high limit to the output	Low limit to Max float* (decimal point depends on resolution)		Conf
Fallback	The state of the Output and Status parameters in case of a fault condition. This parameter could be used in conjunction with fallback value	Clip Bad Clip Good Fall Bad Fall Good Upscale DownScale	Descriptions, see section 7.5.5	Conf
Fallback Val	Defines (in accordance with Fallback) the output value during fault conditions.	Limited to max float * (decimal point depends on resolution)		Conf
In1	Input 1 value (normally wired to an input source - could be a User Value)	Limited to max float * (decimal point depends on resolution)		Oper
In2	Input 2 value (normally wired to an input source - could be a User Value)	Limited to max float * (decimal point depends on resolution)		Oper
Out	Indicates the analogue value of the output	Between high and low limits		R/O
Status	This parameter is used in conjunction with Fallback to indicate the status of the operation. Typically, status is used to flag fault conditions and may be used as an interlock for other operations.	Good Bad		R/O

* Max float in this instrument is $\pm 9,999,999,999$

14.3.3 Sample and Hold Operation

The diagram below shows the operation of the sample and hold feature.

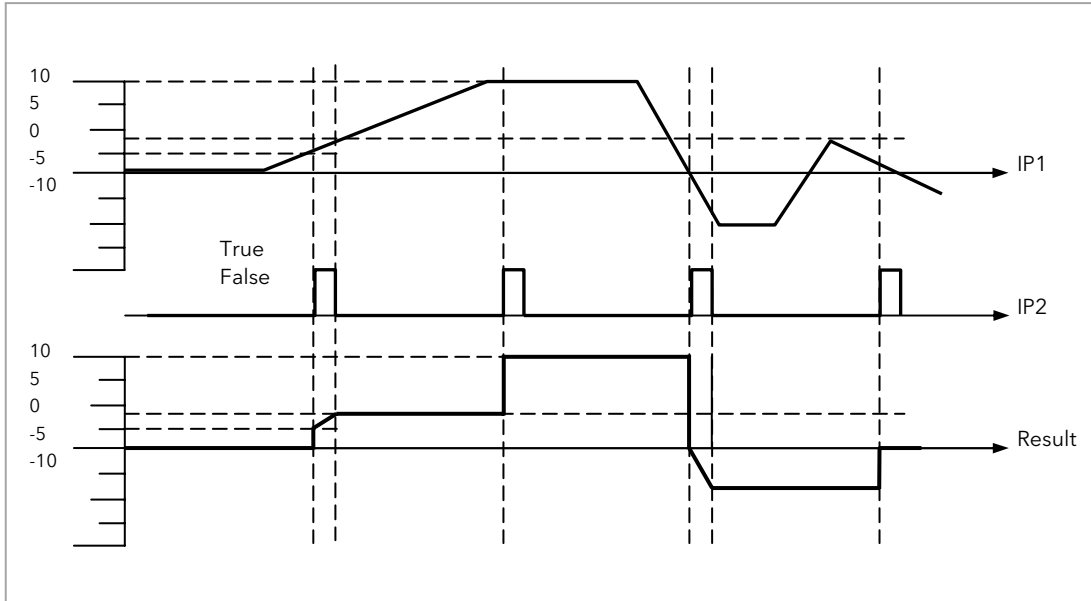

Figure 14-4: Sample and Hold

14.4 Multiple Input Operator Block

The Multiple Input Operator Block simultaneously outputs the Sum, Average, Minimum and Maximum values of up to 8 valid inputs. The outputs will be clipped to user-defined limits or be replaced by a fallback value based on the selected fallback strategy.

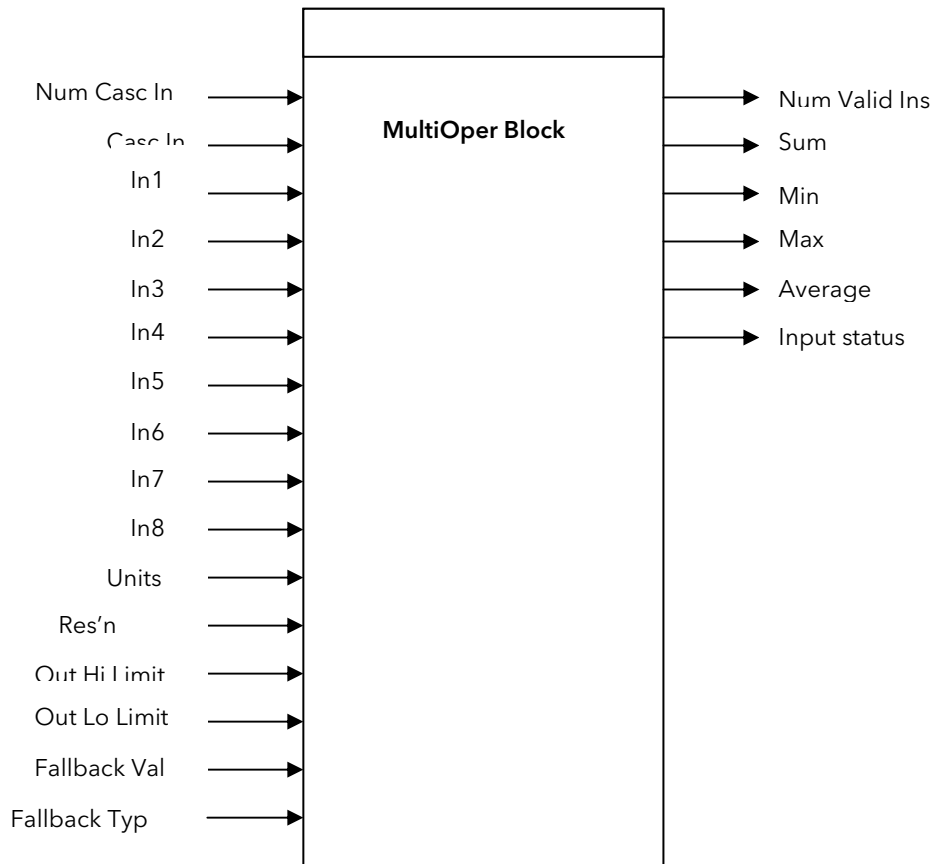

Figure 14-5: Multi Operator Function Block

'Num In' determines the number of inputs made available for use. This is settable by the user and is defaulted to two. The user should be careful not to set this number to a value higher than the desired number of inputs as any unused inputs are seen as valid inputs to the block (zero value by default). Num Casc In and Casc In will always be available.

'Input Status' gives an indication of the status of the inputs in priority order. Casc In has the highest priority, In1 the next highest up to In8 the lowest. Should more than one input be bad then the input with the highest priority is shown as bad. When the highest priority bad status is cleared the next highest priority bad status is shown. When all inputs are OK a status of OK is shown.

'Number of valid inputs' provides a count of the number of inputs used to perform the calculation within the block. This is required for cascaded operation and is detailed below.

14.4.1 Cascaded operation

Multiple input operator blocks may be cascaded to allow operations on more than eight inputs (33 max for four instances of the block). shows how two blocks should be configured to find the average of more than eight inputs. If required the second block could then be cascaded to a third to provide up to eight more inputs.

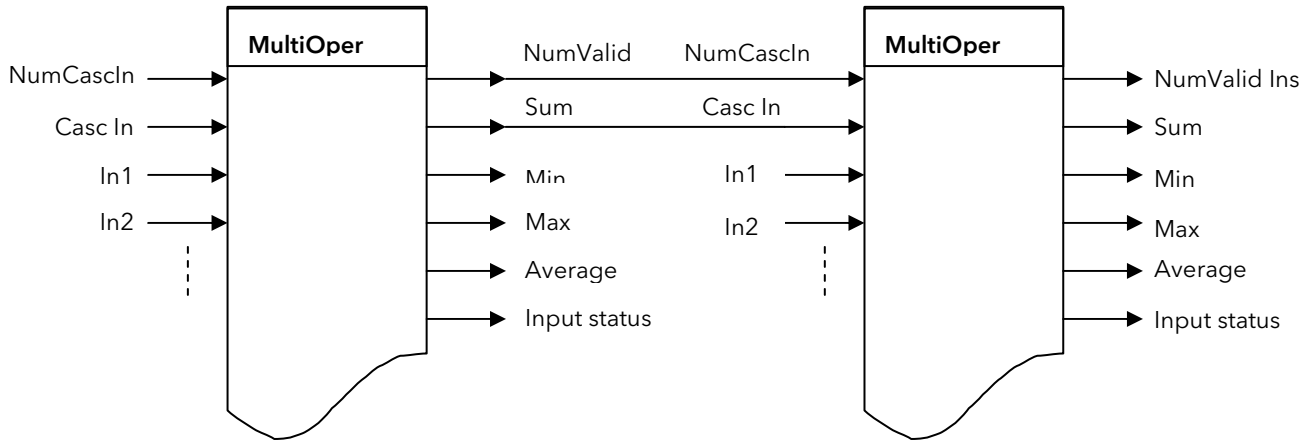

Figure 14-6: Cascaded Multi Operator Function Blocks

If 'Cascln' is has Good status, and 'NumCascln' is not equal to zero we can assume that the block is in cascade and these values are used for calculations within the block, and the value given by 'NumCascln' is added to 'NumValidIns'. When in cascade the sum, min, max and average outputs treat Casc In as an additional input to the block. For example if Casc In is greater than any number on the rest of the inputs then its value will be output as the max.

14.4.2 Fallback Strategy

The user is able to select the fallback strategy during config. The options are:-

Clip Good

- The status of the outputs is always good
- If an output is out of range then it is clipped to limits
- If all inputs are bad, all outputs = 0 (Or clipped to limits if 0 is not within the output range)

Clip Bad

- The status of all outputs is bad if one or more of the inputs are bad
- If an output is out of range then it is clipped to limits and the status of that output is set to bad
- If all inputs are bad, all outputs = 0 and all status' are set to bad (Or clipped to limits if 0 is not within the output range)

Fall Good

- The status of the outputs is always good
- If an output is out of range then it is set to the fallback value
- If all inputs are bad, all outputs = fallback value

Fall Bad

- The status of all outputs is bad if one or more of the inputs are bad
- If an output is out of range then it is set to the fallback value and the status is set to bad
- If all inputs are bad, all outputs are set to the fallback value and all statuses are set to bad

14.4.3 Multiple Input Operator Block Parameters

Folder - MultiOper (Multi Operator)		Sub-folders: 1 to 4		
Name	Parameter Description	Value	Default	Access Level
NumIn	Number of inputs selected to use.	2 to 8	2	Config
CascNumIn	Number of cascaded inputs from the previous block	0 to 255	0	R/O
CascIn	The cascaded input from a previous block	-99999 to 99999 (decimal point depends on Resolution)	0	R/O
In 1 to In 8	Input 1	-99999 to 99999 (decimal point depends on Resolution)	0	R/O
Units	Selected units for the I/O	Unit8 (nvol)	None	Config
Resolution	Selected resolution of the Outputs	X to X.XXX	X	Config
OutHi Limit	Upper limit of the outputs.	-99999 to 99999 (decimal point depends on Resolution). Minimum setting is limited by 'OutLoLimit'.	0	Config
OutLo Limit	Lower limit of the outputs.	-99999 to 99999 (decimal point depends on Resolution). Maximum setting is limited by 'OutHiLimit'.	0	Config
Fallback Val	Value to be output depending on Input status and fallback type selected.	-99999 to 99999 (decimal point depends on Resolution)	0	Config
Fallback Typ	Fallback Type selected.)	Clip Bad Clip Good Fall Bad Fall Good Upscale DownScale	See section 14.4.2	Clip Good Config
NumValidIn	Number of inputs used in the calculated outputs (Output)	2 to 8	0	R/O
Sum Out	Sum of the valid inputs (Output)	-99999 to 99999 (decimal point depends on Resolution)	0	R/O
Max Out	Maximum value of the valid inputs (Output)	-99999 to 99999 (decimal point depends on Resolution)	0	R/O
Min Out	Minimum value of the valid inputs (Output)	-99999 to 99999 (decimal point depends on Resolution)	0	R/O
Average Out	Average value of the valid inputs (Output)	-99999 to 99999 (decimal point depends on Resolution)	0	R/O
Input Status	Status of the inputs (Output)	-99999 to 99999 (decimal point depends on Resolution)	0	R/O

14.5 Eight Input Analog Multiplexers

The eight Input analogue multiplexers may be used to switch one of eight inputs to an output. It is usual to wire inputs to a source within the controller that selects that input at the appropriate time or event.

14.5.1 Multiple Input Operator Parameters

Folder - Mux8 (8 Input Multiplexers)		Sub-folders: 1 to 4		
Name	Parameter Description	Value	Default	Access Level
LowLimit	The low limit for all inputs and the fall back value.	-99999 to High limit (decimal point depends on resolution)		Conf
HighLimit	The high limit for all inputs and the fall back value.	Low limit to 99999 (decimal point depends on resolution)		Conf
Fallback	The state of the Output and Status parameters in case of a fault condition. This parameter could be used in conjunction with Fallback Val.	Clip Bad Clip Good Fall Bad Fall Good Upscale DownScale	Descriptions see section 14.4.2.	Conf
Fallback Val	Used (in accordance with Fallback) to define the output value during fault conditions	-99999 to 99999 (decimal point depends on resolution)		Conf
Select	Used to select which input value is assigned to the output.	Input1 to Input8		Oper
In1 to 8	Input values (normally wired to an input source)	-99999 to 99999 (decimal point depends on resolution)		Oper
Out	Indicates the analogue value of the output	Between high and low limits		R/O
Status	Used in conjunction with Fallback to indicate the status of the operation. Typically, status is used to flag fault conditions and may be used as an interlock for other operations.	Good Bad		R/O

14.5.2 Fallback

The fallback strategy will come into effect if the status of the input value is bad or if the input value is outside the range of Input Hi and Input Lo.

In this case the fallback strategy may be configured as:-

- Fall Good** If the input value is above 'High Limit' or below 'Low Limit', then the output value is set to the 'Fallback' value, and the 'Status' is set to 'Good'.
- Fall Bad** If the input value is above 'High Limit' or below 'Low Limit', then the output value is set to the 'Fallback' value, and the 'Status' is set to 'Bad'.
- Clip Good** If the input value is above 'High Limit' or below 'Low Limit', then the output value is set to the appropriate limit, and 'Status' is set to 'Bad'. If the input signal is within the limits, but its status is bad, the output is set to the 'Fallback' value.
- Clip Bad** If the input value is above 'High Limit' or below 'Low Limit', then the output value is set to the appropriate limit, and 'Status' is set to 'Good'. If the input signal is within the limits, but its status is bad, the output is set to the 'Fallback' value
- Upscale** If the input status is bad, or if the input signal is above 'High Limit' or below 'Low Limit', the output value is set to the 'High Limit'.
- Downscale** If the input status is bad, or if the input signal is above 'High Limit' or below 'Low Limit', the output value is set to the 'Low Limit'.

15. Chapter 15 Input Characterisation

15.1 Input Linearisation

The Lin16 function block converts an input signal into an output PV using a series of up to 15 straight lines to characterise the conversion.

The function block provides the following behaviour.

1. The Input values must be monotonic and constantly rising.
2. To convert the MV to the PV, the algorithm will search the table of inputs until the matching segment is found. Once found, the points either side will be used to interpolate the output value.
3. If during the search, a point is found which is not above the previous (below for inverted) then the search will be terminated and the segment taken from the last good point to the extreme (In Hi-Out Hi) see following diagram.

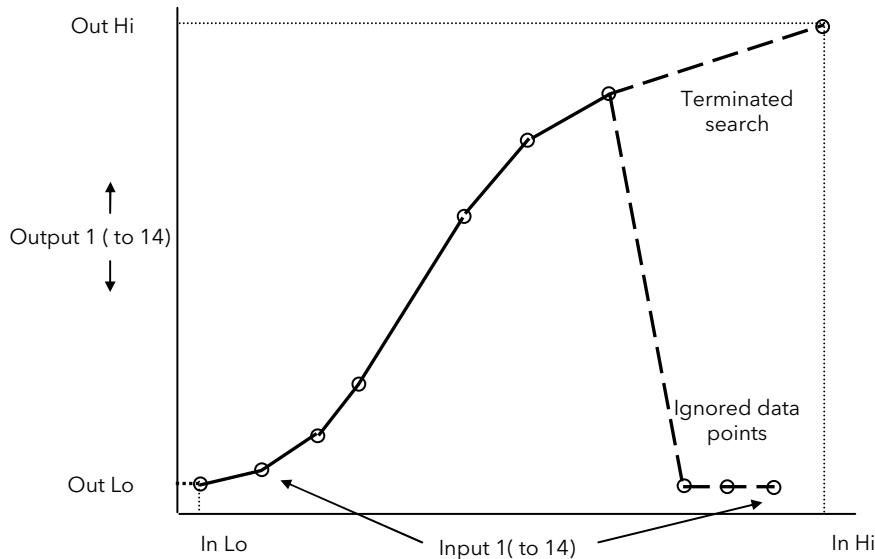

Figure 15-1: Linearisation Example

Notes:

1. The linearisation block works on rising inputs/rising outputs or rising inputs/falling outputs. It is not suitable for outputs which rise and fall on the same curve.
2. Input Lo/Output Lo and Input Hi/Output Hi are entered first to define the low and high points of the curve. It is not necessary to define all 15 intermediate points if the accuracy is not required. Points not defined will be ignored and a straight line fit will apply between the last point defined and the Input Hi/Output Hi point. If the input source has a bad status (sensor break, or over-range) then the output value will also have a bad status.

1. If the input value is outside the translated range then the output status will indicate Bad, and the value will be limited to the nearest output limit.
2. The units and resolution parameters will be used for the output values. The input values resolution and units will be specified by the source of the wire.
3. If the 'Out Low' is higher than the 'Out High' then the translation will be inverted.

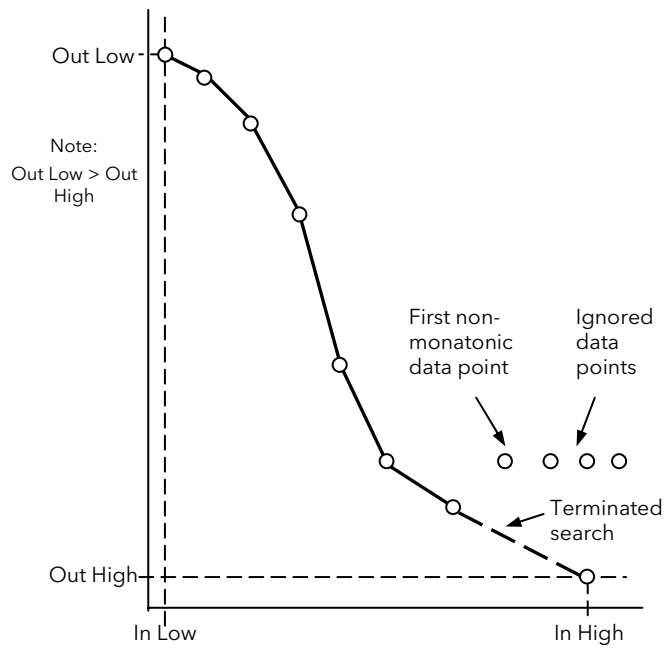

Figure 15-2: How an Inverted Curve will Terminate its search when it detects non-monotonic data

15.1.1 Compensation for Sensor Non-Linearities

The custom linearisation feature can also be used to compensate for errors in the sensor or measurement system. The intermediate points are, therefore, available in Level 1 so that known discontinuities in the curve can be calibrated out. The diagram below shows an example of the type of discontinuity which can occur in the linearisation of a temperature sensor.

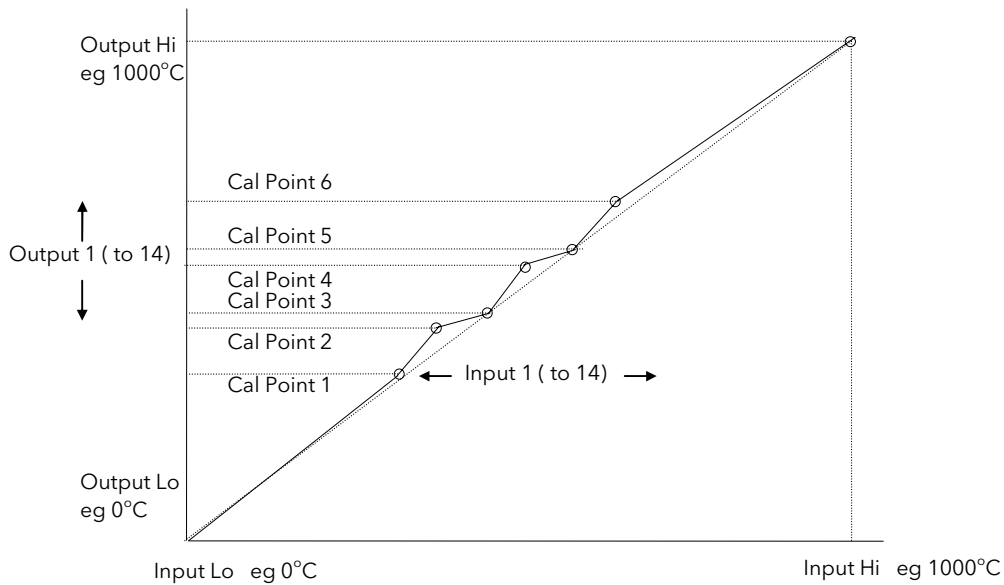

Figure 15-3: Compensation for Sensor Discontinuities

The calibration of the sensor uses the same procedure as described above. Adjust the output (displayed) value against the corresponding input value to compensate for any errors in the standard linearisation of the sensor.

15.1.2 Input Linearisation Parameters

List Folder - Lin16		Sub-folders: 1 to 2			
Name	Parameter Description	Value	Default	Access Level	
Units	Units of the linearised output	None AbsTemp V, mV, A, mA, PH, mmHg, psi, Bar, mBar, %RH, %, mmWG, inWG, inWW, Ohms, PSIG, %O2, PPM, %CO2, %CP, %/sec, RelTemp mBar/Pa/T sec, min, hrs,		Conf	
Resolution	Resolution of the output value	XXXXX. XXXX.X, XXX.XX, XX.XXX, X.XXXX		Conf	
In	Input measurement to linearise. Wire to the source for the custom linearisation	Between InLowLimit and InHighLimit	0	Oper	
FallbackType	Fallback Type The fallback strategy will come into effect if the status of the input value is bad or if the input value is outside the range of input high scale and input low scale. In this case the fallback strategy may be configured as shown:-	Clip Bad	If the input is outside a limit the output will be clipped to the limit and the status will be BAD	ClipBad	Oper
		Clip Good	If the input is outside a limit the output will be clipped to the limit and the status will be GOOD		
		Fall Bad	The output value will be the fallback value and the output status will be BAD		
		Fall Good	The output value will be the fallback value and the output status will be GOOD		
		Upscale	The output value will be output high scale and the output status will be BAD		
		DownScale	The output value will be the output low scale and the output status will be BAD		
Fallback Value	In the event of a bad status, the output may be configured to adopt the fallback value. This allows the strategy to dictate a safe output in the event of a fault being detected.		0	Oper	
Out	Linearisation Result	Between OutLowLimit and OutHighLimit		R/O	
InLowLimit	Adjust to the low input value	-99999 to InHighLimit	0	Conf	
OutLowLimit	Adjust to correspond to the low input value	-99999 to OutHighLimit	0	Conf	
InHighLimit	Adjust to the high input value	InLowLimit to 99999	0	Conf	
OutHighLimit	Adjust to correspond to the high input value	OutLowLimit to 99999	0	Conf	
In1	Adjust to the first break point		0	Oper	
Out1	Adjust to correspond to input 1		0	Oper	
...etc up to			0		
In14	Adjust to the last break point		0	Oper	

List Folder - Lin16		Sub-folders: 1 to 2			
Name	Parameter Description	Value		Default	Access Level
Out14	Adjust to correspond to input 14			0	Oper
Status	Status of the block. A value of zero indicates a healthy conversion.	Good Bad	Within operating limits A bad output may be caused by a bad input signal (perhaps the input is in sensor break) or an output which is out of range		R/O

The 16 point linearisation does not require you to use all 16 points. If fewer points are required, then the curve can be terminated by setting the first unwanted value to be less than the previous point.

Conversely if the curve is a continuously decreasing one, then it may be terminated by setting the first unwanted point above the previous one.

15.2 Polynomial

Folder - Poly		Sub-Folders: 1 to 2			
Name	Parameter Description	Value		Default	Access Level
LinType	To select the input type. The linearisation type selects which of the instruments linearisation curves is applied to the input signal. The instrument contains a number of thermocouple and RTD linearisations as standard. In addition there are a number of custom linearisations that may be downloaded using iTools to provide linearisations of non-temperature sensors.	J , K, L, R, B, N, T, S, PL2, C, PT100, Linear, SqRoot		J	Conf
Units	Units of the output	None AbsTemp V, mV, A, mA, PH, mmHg, psi, Bar, mBar, %RH, %, mmWG, inWG, inWW, Ohms, PSIG, %O2, PPM, %CO2, %CP, %/sec, RelTemp mBar/Pa/T sec, min, hrs,		None	Conf
Resolution	Resolution of the output value	XXXXX. XXXX.X, XXX.XX, XX.XXX, X.XXXX		XXXXX	Conf
In	Input Value The input to the linearisation block	Range of the input wired from			Oper
Out	Output value	Between Out Low and Out High			R/O
InHighScale	Input high scale	In Low to 99999		0	Oper
InLowScale	Input low scale	-99999 to In High		0	Oper
OutHighScale	Output high scale	Out Low to 99999		0	Oper
OutLowScale	Output low scale	-99999 to Out High		0	Oper

Folder - Poly		Sub-Folders: 1 to 2			
Name	Parameter Description	Value		Default	Access Level
Fallback Type	Fallback Type The fallback strategy will come into effect if the status of the input value is bad or if the input value is outside the range of input high scale and input low scale. In this case the fallback strategy may be configured as:	Clip Bad	If the input is outside a limit the output will be clipped to the limit and the status will be BAD		Conf
		Clip Good	If the input is outside a limit the output will be clipped to the limit and the status will be GOOD		
		Fall Bad	The output value will be the fallback value and the output status will be BAD		
		Fall Good	The output value will be the fallback value and the output status will be GOOD		
		Upscale	The output value will be output high scale and the output status will be BAD		
		Down-Scale	The output value will be the output low scale and the output status will be BAD		
FallbackValue	Value to be adopted by the output in the event of Status = Bad				Oper
Status	Indicates the status of the linearised output:	Good	Good indicates the value is within range and the input is not in sensor break.		R/O
		Bad	Indicates the Value is out of range or the input is in sensor break. Note: This is also effected by the configured fallback strategy		

16. Chapter 16 Load

The load simulation block provides styles of load which can be used to allow an instrument configuration to be tested before connection to the process plant. In the current issue of firmware the simulated loads available are Oven and Furnace.

16.1 Load Parameters

Folder - Load		Sub-Folders: None			
Name	Parameter Description	Value		Default	Access Level
Type	The type of load simulation to use. Oven is a simple load of 3 first order lags, providing a single process value for connection to the control loop. Furnace consists of 12 interactive first order lags giving a slave PV, followed by 6 interactive first order lags giving a master PV.	Oven	Simulates the characteristics of a typical oven	Oven	Conf
		Furnace	Simulates the characteristics of a typical furnace		
Resolution	The display resolution of the resultant PV Out.				Conf
Units	The Units of the resultant PV.				Conf
Gain	The gain of the load, the input power is multiplied by gain, before use by the load.				Oper
TimeConst1	The time constant of lag 1 in the Oven load and slave lags (1-12) of the Furnace load. The time constant has units of seconds.				Oper
TimeConst2	The time constant of lag 2/3 of the Oven load and master lags (13-18) of the furnace load.				Oper
Attenuation (Furnace load only)	Attenuation Between PV1 and PV2 Stages. Used in the advanced furnace load and defines an attenuation factor between the slave and master lags				Oper
Ch 2 Gain	Defines the relative gain when cooling is requested, applied to the input power when the power requested is < 0.				Oper
PVFault	The load function block provides 2 PV outputs, sensor fault can be used to generate a fault condition on these PV's such that the bad status is passed along a wire to be consumed by another block such as the loop. The sensor fault can be configured as:	None	No fault conditions.		Oper
		PVOut1	Fault on the first output (slave).		
		PVOut2	Fault on the second output (master).		
		Both	A fault on first and second outputs (master and slave).		
PV Out1	First Process Value The PV in Process Value an Oven load or the Slave PV in a furnace load.				R/O
PV Out2 (Furnace load only)	Second Process Value Second process value, lagged from PVOut1, used as a cascade master input. The Master PV in the Furnace load.				R/O
LoopOutCh1	Loop output channel 1 input. The output of the loop as wired to the load simulation, this is the power requested of the load. This can be used as the heat demand.				Oper
LoopOutCh2	Loop output channel 2 input. The output of the loop as wired to the load simulation, this is the power requested of the load. This can be used as the cool demand.				Oper
Noise	Noise Added to PV This is used to make the PV of the load appear noisy, and hence more like a real measurement.	Off 1 to 99999	The amount of noise is specified in engineering units.	Off	Oper
Offset	Process offset Used to configure an offset in the process. In a temperature application this could represent the ambient operating temperature of the plant.				Oper

17. Chapter 17 Control Loop Set Up

The Mini8 controller has up to 16 loops of control. Each Loop has two outputs, Channel 1 and Channel 2, each of which can be configured for PID or On/Off.

The control function block is divided into a number of sections the parameters of which are all listed under the Folder 'Loop'.

The 'Loop' folder contains sub-folders for each section as shown diagrammatically below.

17.1 What is a Control Loop?

An example of a heat only temperature control loop is shown below:-

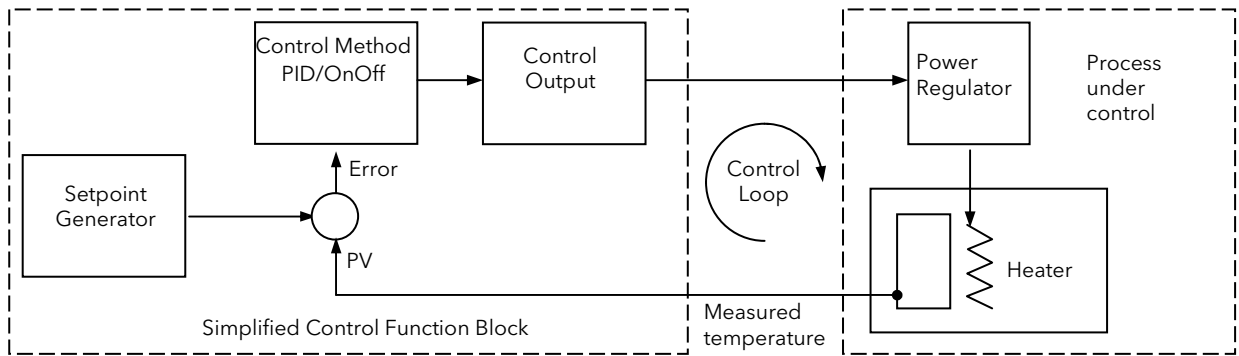

Figure 17-1: Single Loop Single Channel

The actual temperature measured at the process (PV) is connected to the input of the controller. This is compared with a setpoint (or required) temperature (SP). If there is an error between the set and measured temperature the controller calculates an output value to call for heating or cooling. The calculation depends on the process being controlled but normally uses a PID algorithm. The output(s) from the controller are connected to devices on the plant which cause the heating (or cooling) demand to be adjusted which in turn is detected by the temperature sensor. This is referred to as the control loop.

17.2 Loop Parameters - Main

Folder - Loop.1 to Loop.16		Sub-Folder: Main			
Name	Parameter Description	Value		Default	Access Level
AutoMan	To select Auto or Manual operation.	Auto	Automatic (closed loop) operation	Auto	Oper
		Man	Manual (output power adjusted by the user) operation		
PV	The process variable input value. This is typically wired from an analogue input.	Range of the input source			Oper
Inhibit	Used to stop the loop controlling. If enabled the loop will stop control and the output of the loop will be set to the safe output value. On exit from inhibit the transfer will be bumpless. This may be wired to an external source	No Yes	Inhibit disabled Inhibit enabled	No	Oper
TargetSP	The value of setpoint at which the control loop is aiming. It may come from a number of different sources, such as internal SP and remote SP.	Between setpoint limits			Oper
WorkingSP	The current value of the setpoint being used by the control loop. It may come from a number of different sources, such as internal SP and Remote SP. The working setpoint is always read-only as it is derived from other sources.	Between setpoint limits			R/O
ActiveOut	The actual output of the loop before it is split into the channel 1 and channel 2 outputs.				R/O
IntHold	Stops Integral action			No	Oper

17.3 Loop Set up

These parameters configure the type of control.

Folder - Loop.1 to Loop.16		Sub-folder: Setup			
Name	Parameter Description	Value		Default	Access Level
Ch1 ControlType	Selects the channel 1 control algorithm. You may select different algorithms for channels 1 and 2. In temperature control applications, Ch1 is usually the heating channel, Ch2 is the cooling channel.	Off	Channel turned off	PID	Conf
		OnOff	On/off control		
Ch2 ControlType	Control type for channel 2	PID	3 term or PID control		
Control Action	Control Action	Rev	Reverse acting. The output increases when the PV is below SP. This is the best setting for heating control.	Rev	Conf
		Dir	Direct acting. The output increases when the PV is above SP. This is the best setting for cooling control		
PB Units	Proportional band units.	EngUnits	Engineering units eg C or F	Eng	Conf
		Percent	Per cent of loop span (range Hi - Range Lo)		
Derivative Type	Selects whether the derivative acts only on PV changes or on Error (either PV or Setpoint changes).	PV	Only changes in PV cause changes to the derivative output.	PV	Conf
		Error	Changes to either PV or SP will cause a derivative output.		
The above two parameters appear if either Ch1 or Ch2 are configured for PID control					

17.3.1 Types of Control Loop

17.3.1.1 On/Off Control

On/Off control simply turns heating power on when the PV is below setpoint and off when it is above setpoint. If cooling is used, cooling power is turned on when the PV is above setpoint and off when it is below. The outputs of such a controller will normally be connected to relays - hysteresis may be set as described in the Alarms section to prevent relay chatter or to provide a delay in the control output action.

17.3.1.2 PID Control

PID control, also referred to as 'Three Term Control', is a technique used to achieve stable straight line control at the required setpoint. The three terms are:

P = Proportional band

I = Integral time

D = Derivative time

The output from the controller is the sum of the contributions from these three terms. The combined output is a function of the magnitude and duration of the error signal, and the rate of change of the process value. It is possible to turn off integral and derivative terms and control on only proportional, proportional plus integral or proportional plus derivative.

17.4 PID Control

The PID controller consists of the following parameters:-

Parameter	Meaning or Function
Proportional Band 'PB'	The proportional term, in display units or %, delivers an output that is proportional to the size of the error signal.
Integral Time 'Ti'	Removes steady state control offsets by ramping the output up or down in proportion to the amplitude and duration of the error signal.
Derivative Time 'Td'	Determines how strongly the controller will react to the rate of change in the measured value. It is used to prevent overshoot and undershoot and to restore the PV rapidly if there is a sudden change in demand.
High Cutback 'CBH'	The number of display units, above setpoint, at which the controller will increase the output power, in order to prevent undershoot on cool down.
Low Cutback 'CBL'	The number of display units, below setpoint, at which the controller will cutback the output power, in order to prevent overshoot on heat up.
Relative Cool Gain 'R2G'	Only present if cooling has been configured. Sets the cooling proportional band, which equals the heat proportional band value divided by the cool gain value.

17.4.1 Proportional Band

The proportional band, or gain, delivers an output which is proportional to the size of the error signal. It is the range over which the output power is continuously adjustable in a linear fashion from 0% to 100% (for a heat only controller). Below the proportional band (PB) the output is full on (100%), above the proportional band the output is full off (0%) as shown in Figure 17-2.

The width of the proportional band determines the magnitude of the response to the error. If it too narrow (high gain) the system oscillates by being over responsive. If it is too wide (low gain) the control is sluggish. The ideal situation is when the proportional band is as narrow as possible without causing oscillation.

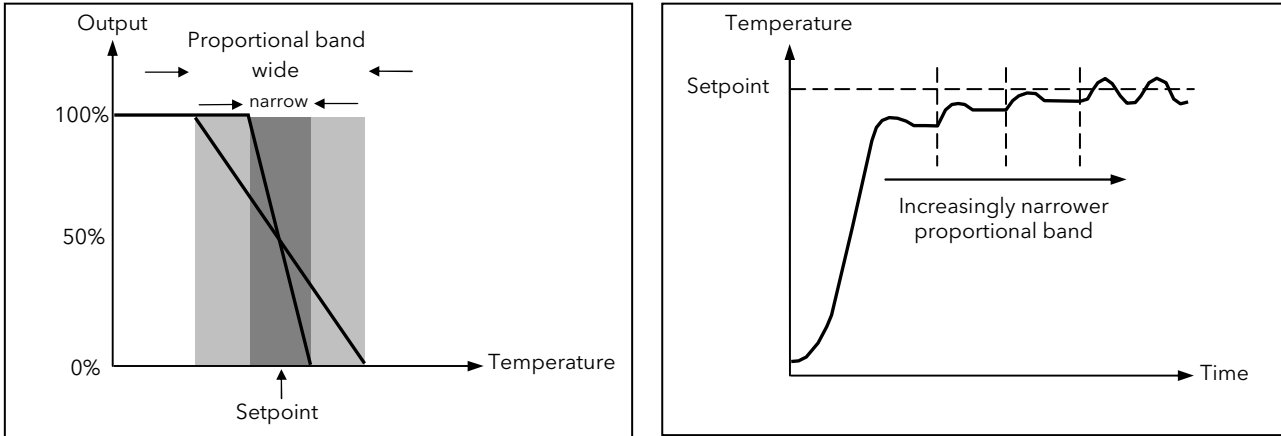

Figure 17-2: Proportional Action

Figure 17-2 also shows the effect of narrowing proportional band to the point of oscillation. A wide proportional band results in straight line control but with an appreciable initial error between setpoint and actual temperature. As the band is narrowed the temperature gets closer to setpoint until finally becoming unstable.

The proportional band may be set in engineering units or as a percentage of the controller range.

17.4.2 Integral Term

In a proportional only controller, an error between setpoint and PV must exist for the controller to deliver power. Integral is used to achieve **zero** steady state control error.

The integral term slowly shifts the output level as a result of an error between setpoint and measured value. If the measured value is below setpoint the integral action gradually increases the output in an attempt to correct the error. If it is above setpoint integral action gradually decreases the output or increases the cooling power to correct the error.

Figure 17-3 shows the result of introducing integral action.

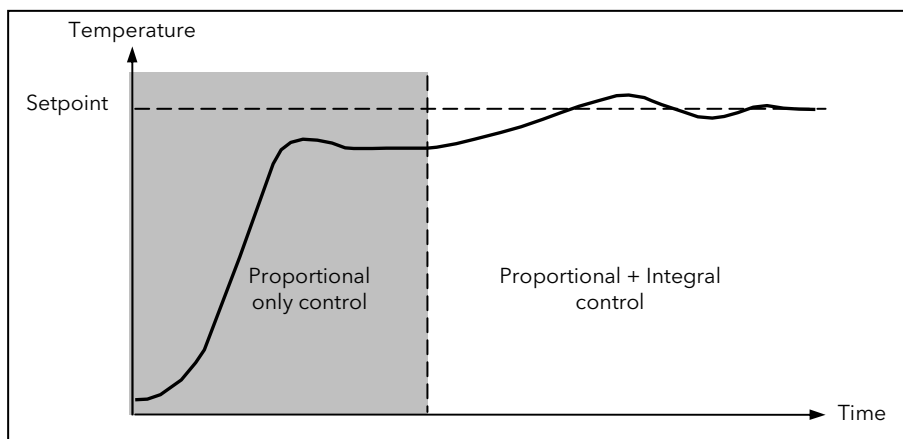

Figure 17-3: Proportional + Integral Control

The units for the integral term are measured in time (1 to 99999 seconds in mini8 controllers). The longer the integral time constant, the more slowly the output is shifted and results in a sluggish response. Too small an integral time will cause the process to overshoot and even oscillate. The integral action may be disabled by setting its value to Off.

17.4.3 Derivative Term

Derivative action, or rate, provides a sudden shift in output as a result of a rapid change in error, whether or not this is caused by PV alone (derivative on PV) or on SP changes as well (derivative on error selection). If the measured value falls quickly derivative provides a large change in output in an attempt to correct the perturbation before it goes too far. It is most beneficial in recovering from small perturbations.

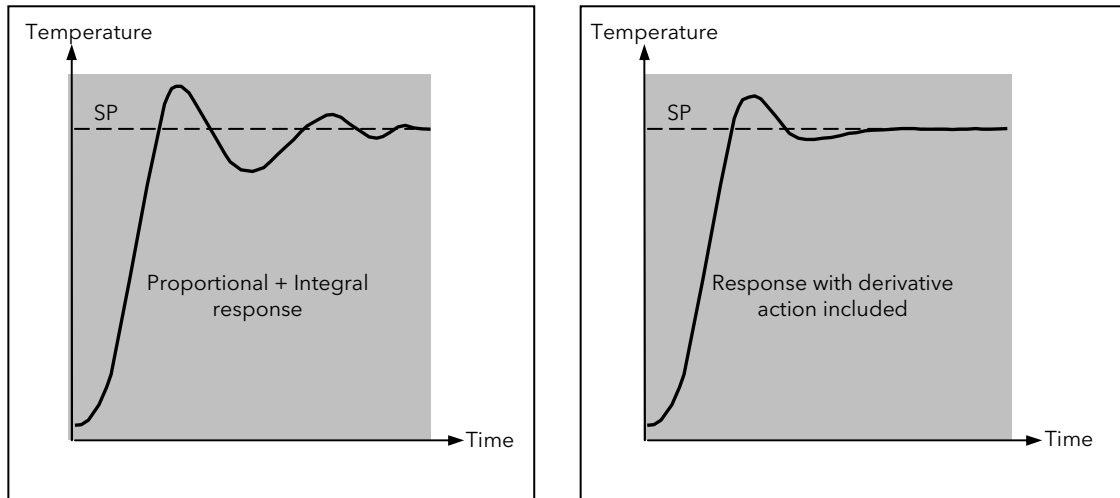

Figure 17-4: Proportional + Integral + Derivative Action

The derivative modifies the output to reduce the rate of change of error. It reacts to changes in the PV by changing the output to remove the transient. Increasing the derivative time will reduce the settling time of the loop after a transient change.

Derivative is often mistakenly associated with overshoot inhibition rather than transient response. In fact, derivative should not be used to curb overshoot on start up since this will inevitably degrade the steady state performance of the system. Overshoot inhibition is best left to the approach control parameters, High and Low Cutback, section 17.4.4.

Derivative is generally used to increase the stability of the loop, however, there are situations where derivative may be the cause of instability. For example, if the PV is noisy, then derivative can amplify that noise and cause excessive output changes, in these situations it is often better to disable the derivative and re-tune the loop.

If set to Off(0), no derivative action will be applied.

Derivative can be calculated on change of PV or change of Error. If configured on error, then changes in the setpoint will be transmitted to the output. For applications such as furnace temperature control, it is common practice to select Derivative on PV to prevent thermal shock caused by a sudden change of output as a result of a change in setpoint.

17.4.4 High and Low Cutback

Cutback high 'CBH' and Cutback low 'CBL' are values that modify the amount of overshoot, or undershoot, that occurs during large step changes in PV (for example, under start-up conditions). They are independent of the PID terms which means that the PID terms can be set for optimal steady state response and the cutback parameters used to modify any overshoot which may be present.

Cutback involves moving the proportional band towards the cutback point nearest the measured value whenever the latter is outside the proportional band and the power is saturated (at 0 or 100% for a heat only controller). The proportional band moves downscale to the lower cutback point and waits for the measured value to enter it. It then escorts the measured value with full PID control to the setpoint. In some cases it can cause a 'dip' in the measured value as it approaches setpoint as shown in Figure 17-5 but generally decreases the time to needed to bring the process into operation.

The action described above is reversed for falling temperature.

If cutback is set to Auto the cutback values are automatically configured to $3 \times PB$.

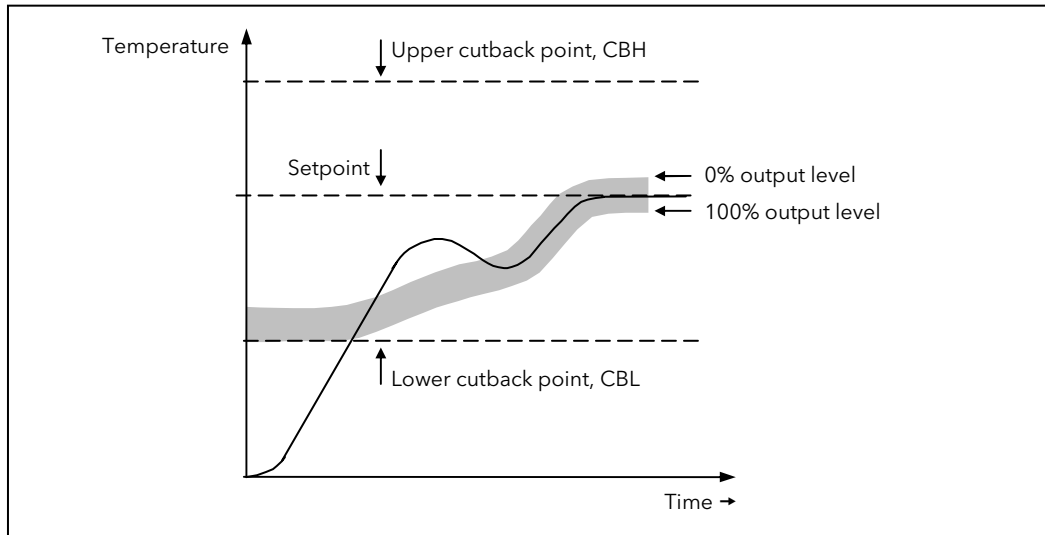

Figure 17-5: High and Low Cutback

17.4.5 Integral action and manual reset

In a full three-term controller (that is, a PID controller), the integral term automatically removes steady state errors from the setpoint. If the controller is set as a PD controller, the integral term will be set to 'OFF'. Under these conditions the measured value may not settle precisely at setpoint. The Manual Reset parameter (MR) represents the value of the power output that will be delivered when the error is zero. You must set this value manually in order to remove the steady state error.

17.4.6 Relative Cool Gain

The gain of channel 2 control output, relative to the channel 1 control output.

Relative Ch2 Gain compensates for the different quantities of energy needed to heat, as opposed to that needed to cool, a process. For example: water cooling applications might require a relative cool gain of 4 (cooling is 4 times faster than the heat-up process).

(This parameter is set automatically when Autotune is used). A nominal setting of around 4 is often used.

17.4.7 Loop Break

The loop is considered to be broken if the PV does not respond to a change in the output in a given time. Since the time of response will vary from process to process the **Loop Break Time (LBT - PID list)** parameter allows a time to be set before a **Loop Break Alarm (Lp Break - Diag list)** is initiated.

The Loop Break Alarm attempts to detect loss of restoring action in the control loop by checking the control output, the process value and its rate of change. This is not to be confused with Load Failure and Partial Load Failure. The loop break algorithm is purely software detection.

Occurrence of a loop break causes the Loop Break Alarm parameter to be set. It does not affect the control action unless it is wired (in software or hardware) to affect the control specifically.

It is assumed that, so long as the requested output power is within the output power limits of a control loop, the loop is operating in linear control and is therefore not in a loop break condition.

However, if the output becomes saturated then the loop is operating outside its linear control region.

Furthermore if the output remains saturated at the same output power for a significant duration, then this could indicate a fault in the control loop. The source of the loop break is not important, but the loss of control could be catastrophic.

Since the worst case time constant for a given load is usually known, a worst case time can be calculated over which the load should have responded with a minimum movement in temperature.

By performing this calculation the corresponding rate of approach towards setpoint can be used to determine if the loop can no longer control at the chosen setpoint. If the PV was drifting away from the setpoint or approaching the setpoint at a rate less than that calculated, the loop break condition would be met.

If an autotune is performed the loop break time is automatically set to $T_i \times 2$ for a PI or PID loop alternatively $12 \times T_d$ for a PD loop. For an On/Off controller loop break detection is also based on loop break time as $0.1 \times \text{SPAN}$ where $\text{SPAN} = \text{Range High} - \text{Range Low}$. Therefore, if the output is at limit and the PV has not moved by $0.1 \times \text{SPAN}$ in the loop break time a loop break will occur.

If the loop break time is 0(off) the loop break time is not set.

If the output is in saturation and the PV has not moved by $>0.5 \times P_b$ in the loop break time, a loop break condition is considered to have occurred.

17.4.8 Cooling Algorithm

The method of cooling may vary from application to application.

For example, an extruder barrel may be cooled by forced air (from a fan), or by circulating water or oil around a jacket. The cooling effect will be different depending on the method. The cooling algorithm may be set to linear where the controller output changes linearly with the PID demand signal, or it may be set to water, oil or fan where the output changes non-linearly against the PID demand. The algorithm provides optimum performance for these methods of cooling.

17.4.9 Gain Scheduling

Gain scheduling is the automatic transfer of control between one set of PID values and another. It may be used in very non-linear systems where the control process exhibits large changes in response time or sensitivity, see diagram below. This may occur, for example, over a wide range of PV, or between heating and cooling where the rates of response may be significantly different. The number of sets depends on the non-linearity of the system. Each PID set is chosen to operate over a limited (approximately linear) range.

In the Mini8 controller, this is done at a preset strategy defined by the parameter 'Scheduler Type'. The choices are:

No.	Type	Description
0	Off	Just one fixed set of PID values
1	Set	The PID set can be selected manually or from a digital input
2	SP	The transfer between one set and the next depends on the value of the SP
3	PV	The transfer between one set and the next depends on the value of the PV
4	Error	The transfer between one set and the next depends on the value of the error
5	OP	The transfer between one set and the next depends on the value of the OP demand
6	Rem Sched IP	The transfer between one set and the next depends on the value from a remote source for example, a digital input

The Mini8 controller has three sets of PID values for each loop - the maximum number, which you may wish to use, is set by 'Num Sets' parameter.

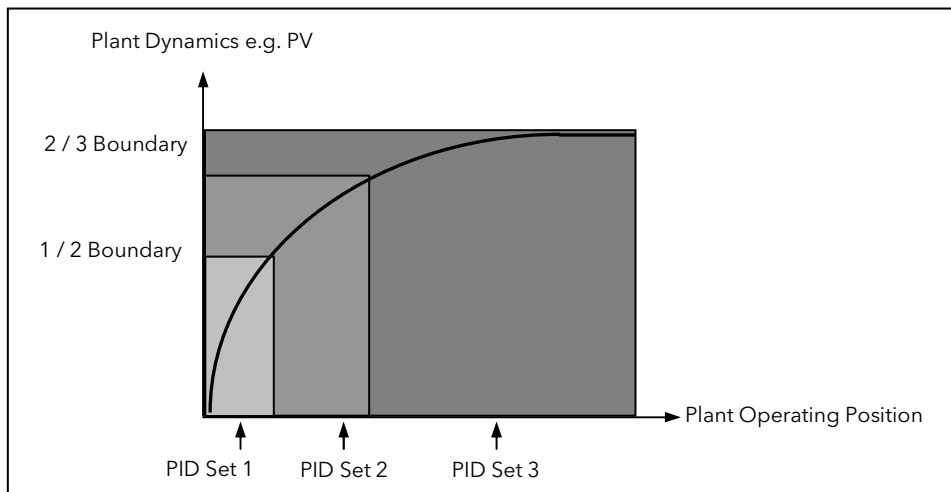

Figure 17-6: Gain Scheduling in a Non-Linear System

17.4.10 PID Parameters

Control loops must be specifically ordered - Order Code MINI8 - 4LP, 8LP or 16LP. To enable a loop place one of the Loop function blocks on the graphical wiring page.

Folder - Loop		Sub-folders: Loop1.PID to Loop16.PID			
Name	Parameter Description	Value		Default	Access Level
SchedulerType	To choose the type of gain scheduling	Off Set SP PV Error OP Rem	See above for explanation Parameters displayed will vary depending on type of scheduling selected.	Off	Oper
Num Sets	Selects the number of PID sets to present. Allows the lists to be reduced if the process does not require the full range of PID sets.	1 to 3		1	Oper
Scheduler RemoteInput	Scheduler Remote Input	1 to 3 (if SchedulerType is 'Remote')		1	R/O
Active Set	Currently working set	Set1 Set2 Set3		Set1	R/O except type 'Set'
Boundary 1-2	Sets the level at which PID set 1 changes to PID set 2	Range units		0	Oper
Boundary 2-3	Sets the level at which PID set 2 changes to PID set 3	Range units		0	Oper
ProportionalBand1, 2, 3	Proportional band Set1/Set2/Set3	0 to 99999 Eng units		300	Oper
IntegralTime 1, 2, 3	Integral term Set1/Set2/Set3			360s	Oper
DerivativeTime 1, 2, 3	Derivative term Set1/Set2/Set3			60s	Oper
RelCh2Gain 1, 2, 3	Relative cool gain Set1/Set2/Set3			1	Oper
CutbackHigh 1, 2, 3	Cutback high Set1/Set2/Set3			Auto	Oper
CutbackLow 1, 2, 3	Cutback low Set1/Set2/Set3			Auto	Oper
ManualReset 1, 2, 3	Manual reset Set1/Set2/Set3. This must be set to 0.0 when the integral term is set to a value			0.0	Oper
LoopBreakTime 1, 2, 3	Loop break time Set1/Set2/Set3			100	Oper
OutputHi 1, 2, 3	Output High Limit Set1/Set2/Set3			100	Oper
OutputLo 1, 2, 3	Output Low Limit Set1/Set2/Set3			-100	

17.5 Tuning Function Block

Tuning involves setting the following parameters.

Proportional Band 'PB', Integral Time 'Ti', Derivative Time 'Td', Cutback High 'CBH', Cutback Low 'CBL', and Relative Cool Gain 'R2G' (applicable to heat/cool systems only).

The controller is shipped with these parameters set to default values. In many cases the default values will give adequate stable straight line control, however, the response of the loop may not be ideal. Because the process characteristics are fixed by the design of the process it is necessary to adjust the control parameters in the controller to achieve best control. To determine the optimum values for any particular loop or process it is necessary to carry out a procedure called loop tuning. If significant changes are later made to the process which affect the way in which it responds it may be necessary to retune the loop.

Users have the choice of tuning the loop automatically or manually. Both procedures require the loop to oscillate and both are described in the following sections.

17.5.1 Loop Response

If we ignore the situation of loop oscillation, there are three categories of loop performance:

Under Damped - In this situation the terms are set to prevent oscillation but do lead to an overshoot of the Process Value followed by decaying oscillation to finally settle at the Setpoint. This type of response can give a minimum time to Setpoint but overshoot may cause problems in certain situations and the loop may be sensitive to sudden changes in Process Value. This will result in further decaying oscillations before settling once again.

Critically Damped - This represents an ideal situation where overshoot to small step changes does not occur and the process responds to changes in a controlled, non oscillatory manner.

Over Damped - In this situation the loop responds in a controlled but sluggish manner which will result in a loop performance which is non ideal and unnecessarily slow.

The balancing of the P, I and D terms depends totally upon the nature of the process to be controlled.

In a plastics extruder, for example, a barrel zone will have a different response to a die, casting roll, drive loop, thickness control loop or pressure loop. In order to achieve the best performance from an extrusion line all loop tuning parameters must be set to their optimum values.

Gain scheduling is provided to allow specific PID settings to be applied at the different operating points of the process.

17.5.2 Initial Settings

In addition to the tuning parameters listed in section 17.5 above, there are a number of other parameters which can have an effect on the way in which the loop responds. Ensure that these are set before either manual or automatic tuning is initiated. Parameters include, but are not limited to:-

Setpoint. Before starting a tune the loop conditions should be set as closely as practicable to the actual conditions which will be met in normal operation. For example, in a furnace or oven application a representative load should be included, an extruder should be running, etc.

Heat/Cool Limits. The minimum and maximum power delivered to the process may be limited by the parameters '**Output Lo**' and '**Output Hi**' both of which are found in the Loop OP list, section 17.7. For a heat only controller the default values are 0 and 100%. For a heat/cool controller the defaults are -100 and 100%. Although it is expected that most processes will be designed to work between these limits there may be instances where it is desirable to limit the power delivered to the process. For example, if driving a 220V heater from a 240V source the heat limit may be set 80% to ensure that the heater does not dissipate more than its maximum power.

Remote Output Limits. '**RemOPL**' and '**RemOPHi**' (Loop OP List). If these parameters are used they should be set within the Heat/Cool Limits above.

Heat/Cool Deadband. In controllers fitted with a second (cool) channel a parameter '**Ch2 DeadBand**' is also available in the Loop OP folder, section 17.7, which sets the distance between the heat and cool proportional bands. The default value is 0% which means that heating will turn off at the same time as cooling turns on. The deadband may be set to ensure that there is no possibility of the heat and cool channels being on together, particularly when cycling output stages are installed.

Minimum On Time. If either or both of the output channels is fitted with a relay or logic output, the parameter '**MinOnTime**' will appear in the relevant output folder - Chapter 7. This is the cycling time for a time proportioning output and should be set correctly before tuning is started.

Input Filter Time Constant. The parameter '**Filter Time Constant**' is found in the IO folder section 7.5.1.

Output Rate limit. Output rate limit is active during tuning and may affect the tuning results. The parameter '**Rate**' is found in the Loop OP folder.

Other Considerations

- If a process includes adjacent interactive zones, each zone should be tuned independently.
- It is always better to start a tune when the PV and setpoint are far apart. This allows start up conditions to be measured and cutback values to be calculated more accurately.
- If the two loops are connected for cascade control, the inner loop may be tuned automatically but the outer should be tuned manually.
- In a programmer/controller tuning should only be attempted during dwell periods and not during ramp stages. If a programmer/controller is tuned automatically put the controller into Hold during each dwell period whilst autotune is active. It may be worth noting that tuning, carried out in dwell periods which are at different extremes of temperature may give different results owing to non linearity of heating (or cooling). This may provide a convenient way to establish values for Gain Scheduling (see section 17.4.9).

☺ If an auto tune is initiated there are two further parameters which need to be set. These are 'OutputHigh Limit' and 'OutputLow Limit'. These are found in the 'Tune' folder, see also section 17.5.5.

17.5.3 Multi-zone applications.

The tuning of one loop can be unduly influenced by the controlling effect of adjacent zone(s). Ideally the zone either side of the one being tuned should be turned OFF, or put in manual with the power level set to keep its temperature at about the usual operating level.

17.5.4 Automatic Tuning

Auto Tune automatically sets the following parameters:-

Proportional Band ' PB '	
Integral Time ' Ti '	If ' Ti ' and/or ' Td ' is set to OFF, because you wish to use PI, PD or P only control, these terms will remain off after an autotune.
Derivative Time ' Td '	
Cutback High ' CBH '	If CBH and/or CBL is set to ' Auto ' these terms will remain at Auto after an autotune, i.e. 3*PB. For autotune to set the cutback values, CBH and CBL must be set to a value (other than Auto) before autotune is started. Autotune will never return cutback values which are less than 1.6*PB.
Cutback Low ' CBL '	
Relative Cool Gain ' R2G '	R2G is only calculated if the controller is configured as heat/cool. Following an autotune, ' R2G ' is always limited to between 0.1 and 10. If the calculated value is outside this limit a 'Tune Fail' alarm is given. In software releases up to and including 2.30, if the calculated value is outside this limit, R2G remains at its previous value but all other tuning parameters are changed.
Loop Break Time ' LBT '	Following an autotune, ' LBT ' is set to 2*Ti (assuming the integral time is not set to OFF). If ' Ti ' is set to OFF then ' LBT ' is set to 12*Td.

Auto tune uses the 'one-shot' tuner which works by switching the output on and off to induce an oscillation in the process value. From the amplitude and period of the oscillation, it calculates the tuning parameter values. The autotune sequence for different conditions is described in sections 17.5.11 to 17.5.13.

17.5.5 Tune Parameters

Folder - Loop.Loop.1 to Loop.16		Sub-folder: Tune			
Name	Parameter Description	Value		Default	Access Level
AutoTune Enable	To start self tuning	Off On	Stop Start	Stop	Oper
OutputHigh Limit	Set this to limit the maximum output power level which the controller will supply during the tuning process. If the high output power limit set in the output list is lower the autotune high limit will be clipped to this value.	Between Low Output and 100.0		100.0	Oper
OutputLow Limit	Set this to limit the minimum % output power level which the controller will supply during the tuning process. If the low output power limit set in the output list is higher the autotune low limit will be clipped to this value.	Between High Output and 0.0		0.0	Oper
State	Shows if self tuning is in progress	Off	Not running	Off	R/O
		Ready			
		Running	In progress		
		Complete	Auto tune completed successfully		
		Timeout	Error conditions, see section 0 - Failure Modes.		
		TI_Limit			
R2G_Limit					
Stage	Shows the progress of the self tuning	Reset		Reset	R/O
		Settling	Displayed during the first minute		
		To SP	Heat (or cool) output on		
		Wait Min	Power output off		
		Wait Max	Power output on		
		Timeout	Error conditions, see section 0 - Failure Modes.		
		TI Limit			
		R2G Limit			
Stage Time	Time in the particular stage				R/O

17.5.6 To Auto Tune a Loop - Initial Settings

Set parameters listed in section 17.5.2.

'Output High Limit' and 'Output Low Limit' ('OP' List section 17.7) set the overall output limits. These limits apply at all times during tuning and during normal operation.

Set 'OutputHigh Limit' and 'Output Low Limit' ('Tune' list section 17.5.5). These parameters set the output power limits during Autotune.

- ☺ The 'tighter' power limit will always apply. For example if 'OutputHigh Limit' (Tune List) is set to 80% and 'Output High Limit' (OP List) is set to 70% then the output power will be limited to 70%.
- ☺ The measured value *must* oscillate to some degree for the tuner to be able to calculate values. The limits must be set to allow oscillation about the setpoint.

17.5.7 To Start Autotune

- a. Select the loop to be tuned,
- b. Set AutoTune Enable to On

A One-shot Tune can be performed at any time, but normally it is performed only once during the initial commissioning of the process. However, if the process under control subsequently becomes unstable (because its characteristics have changed), it may be necessary to tune again for the new conditions.

The auto tune algorithm reacts in different ways depending on the initial conditions of the plant. The explanations given in this section are for the following conditions:-

1. Initial PV is below the setpoint and, therefore, approaches the setpoint from below for a heat/cool control loop
 2. Initial PV is below the setpoint and, therefore, approaches the setpoint from below for a heat only control loop
 3. Initial PV is at the same value as the setpoint. That is, within 0.3% of the range of the controller if **'PB Units'** (Setup list) is set to **'Percent'** or ± 1 engineering unit (1 in 1000) if the **'PB Units'** is set to **'Eng'**. Range is defined as 'Range Hi' - 'Range Lo' for process inputs or the full temperature range defined for the relevant temperature input section 7.5.2.
- ☺ If the PV is just outside the range stated above the autotune will attempt a tune from above or below SP.

17.5.8 Autotune and Sensor Break

When the controller is autotuning and sensor break occurs, the autotune will abort and the controller will output the sensor break output power **'Sbrk OP'** set up in the OP List. Autotune must be re-started when the sensor break condition is no longer present.

17.5.9 Autotune and Inhibit

If the controller is in autotune when inhibit is asserted the tune goes to the OFF state (Stage = Reset). On inhibit being released the controller will re-start autotune.

17.5.10 Autotune and Gain Scheduling

When gain scheduling is enabled and an autotune is performed, the calculated PID values will be written into the PID set that is active on completion of the tune. Therefore, the user may tune within the boundaries of a set and the values will be written into the appropriate PID set. However, if the boundaries are close, since the range of the loop is not large, then, at the completion of the tune, it cannot be guaranteed that the PID values will be written to the correct set particularly if the schedule type is PV or OP. In this situation the scheduler (**'SchedulerType'**) should be switched to 'Set' and the 'Active Set' chosen manually.

17.5.11 Autotune from Below SP - Heat/Cool

The point at which Automatic tuning is performed (Tune Control Point) is designed to operate just below the setpoint at which the process is normally expected to operate (Target Setpoint). This is to ensure that the process is not significantly overheated or overcooled. The Tune Control Point is calculated as follows:-

$$\text{Tune Control Point} = \text{Initial PV} + 0.75(\text{Target Setpoint} - \text{Initial PV}).$$

The Initial PV is the PV measured at 'B' (after a 1 minute settling period)

Examples: If Target Setpoint = 500°C and Initial PV = 20°C, then the Tune Control Point will be 380°C.

If Target Setpoint = 500°C and Initial PV = 400°C, then the Tune Control Point will be 475°C.

This is because the overshoot is likely to be less as the process temperature is already getting close to the target setpoint.

The sequence of operation for a tune from below setpoint for a heat/cool control loop is described below:-

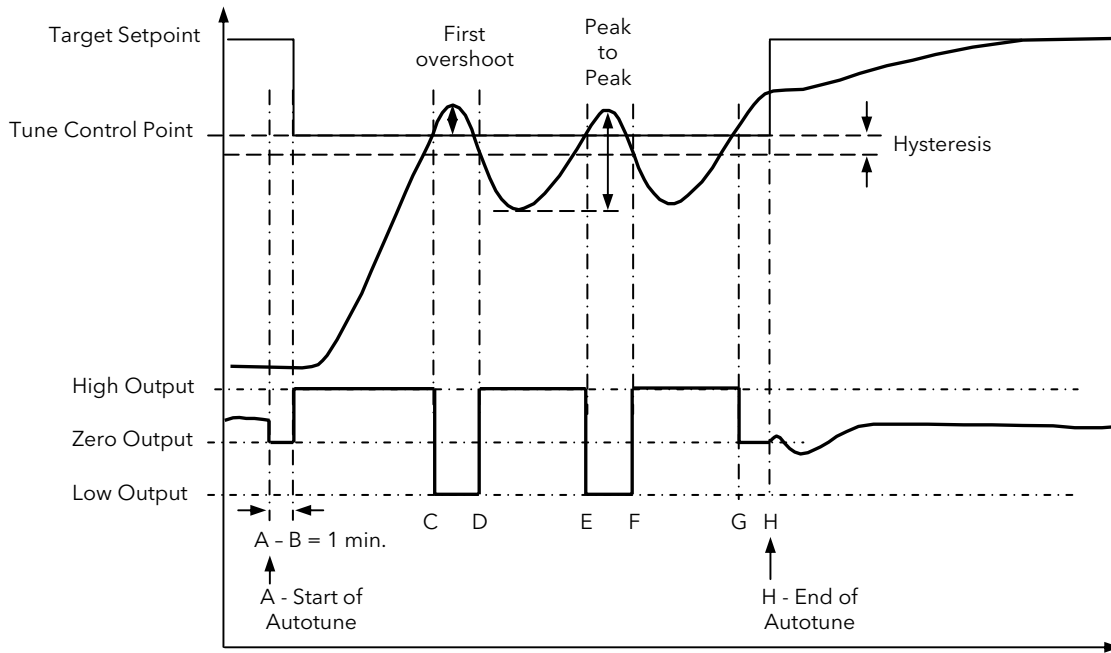

Figure 17-7: Autotune - Heat/Cool Process

Period	Action
A	Start of Autotune
A to B	Both heating and cooling power remains off for a period of 1 minute to allow the algorithm to establish steady state conditions.
B to D	First heat/cool cycle to establish first overshoot. 'CBL' is calculated on the basis of the size of this overshoot (assuming it is not set to Auto in the initial conditions).
B to F	Two cycles of oscillation are produced from which the peak to peak response and the true period of oscillation are measured. PID terms are calculated
F to G	An extra heat stage is provided and all heating and cooling power is turned off at G allowing the plant to respond naturally. Measurements made during this period allow the relative cool gain ' R2G ' to be calculated. 'CBH' is calculated from CBL*R2G.
H	Autotune is turned off at and the process is allowed to control at the target setpoint using the new control terms.

Autotune can also occur when the initial PV is above SP. The sequence is the same as tuning from below setpoint except that the sequence begins with full cooling applied at 'B' after the first one minute settling time.

17.5.12 Autotune From Below SP - Heat Only

The sequence of operation for a heat only loop is the same as that previously described for a heat/cool loop except that the sequence ends at 'F' since there is no need to calculate 'R2G'.

At 'F' autotune is turned off and the process is allowed to control using the new control terms.

Relative cool gain, 'R2G', is set to 1.0 for heat only processes.

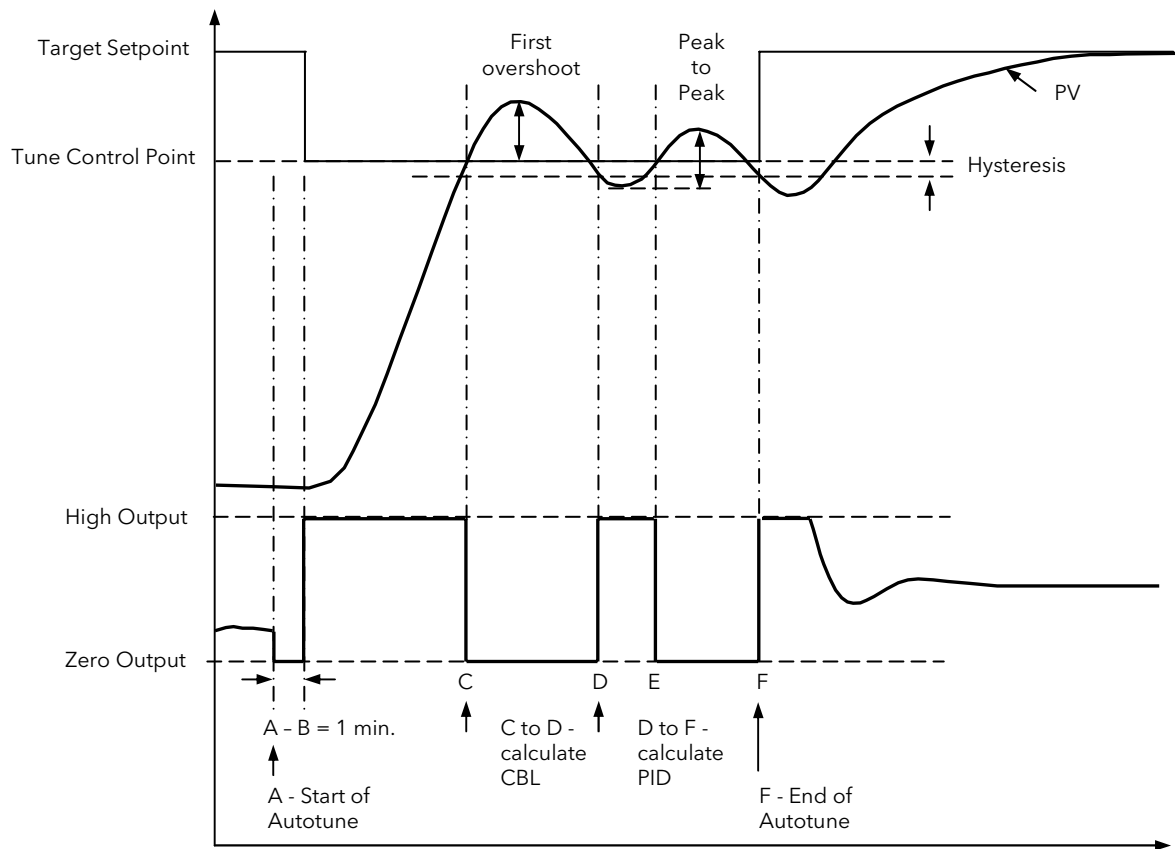

Figure 17-8: Autotune from below SP - Heat Only

For a tune from below setpoint 'CBL' is calculated on the basis of the size of the overshoot (assuming it was not set to Auto in the initial conditions). CBH is then set to the same value as CBL.

Note:- As with the heat/cool case, Autotune can also occur when the initial PV is above SP. The sequence is the same as tuning from below setpoint except that the sequence starts with natural cooling applied at 'B' after the first one minute settling time.

In this case CBH is calculated - CBL is then set to the same value as CBH.

17.5.13 Autotune at Setpoint - Heat/Cool

It is sometimes necessary to tune at the actual setpoint being used. This is allowable in Mini8 Controller and the sequence of operation is described below.

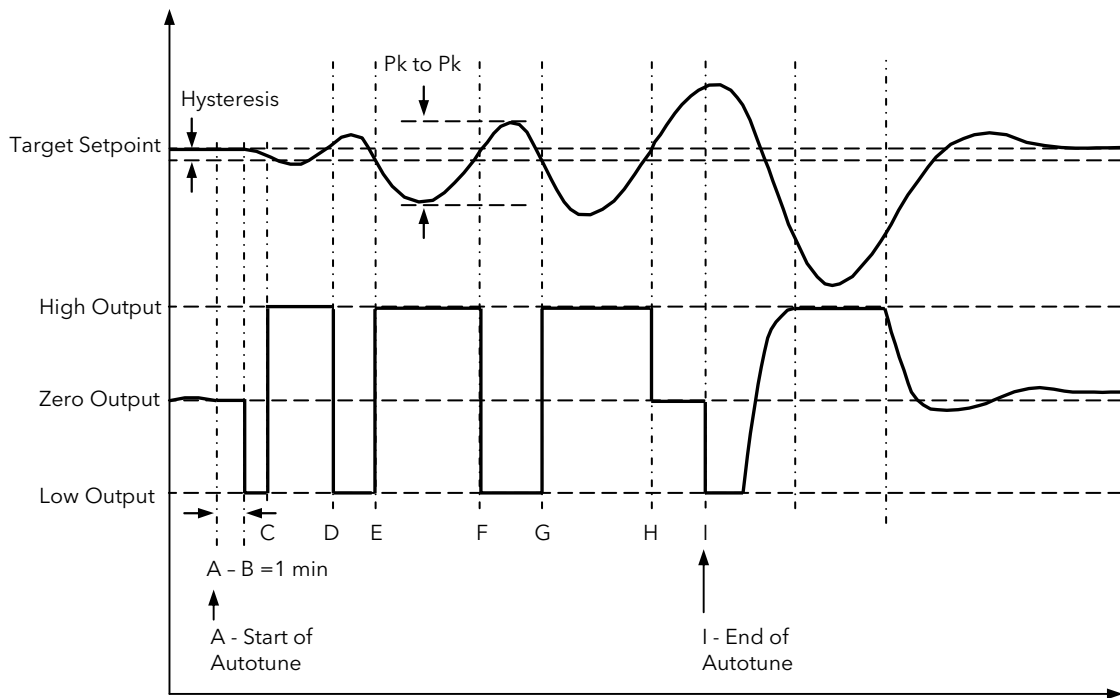

Figure 17-9: Autotune at Setpoint

Period	Action
A	Start of Autotune. A test is done at the start of autotune to establish the conditions for a tune at setpoint. The conditions are that the SP must remain within 0.3% of the range of the controller if 'PB Units' (Setup list) is set to 'Percent'. If 'PBUnits' is set to 'Eng' then the SP must remain within ± 1 engineering unit (1 in 1000). Range is defined as 'Range Hi' - 'Range Lo' for process inputs or the range defined in section 7.5.2 for temperature inputs.
A to B	The output is frozen at the current value for one minute and the conditions are continuously monitored during this period. If the conditions are met during this period autotune at setpoint is initiated at B. If at any time during this period the PV drifts outside the condition limits a tune at setpoint is abandoned. Tuning is then resumed as a tune from above or below setpoint depending on which way the PV has drifted. Since the loop is already at setpoint there is no need to calculate a Tune Control Setpoint - the loop is forced to oscillate around the Target Setpoint
C to G	Initiate oscillation - the process is forced to oscillate by switching the output between the output limits. From this the period of oscillation and the peak to peak response is measured. PID terms are calculated
G to H	An extra heat stage is provided and all heating and cooling power is turned off at H allowing the plant to respond naturally. Measurements made during this period allow the relative cool gain ' R2G ' to be calculated.
I	Autotune is turned off and the process is allowed to control at the target setpoint using the new control terms.

For a tune at setpoint autotune does not calculate cutback since there was no initial start up response to the application of heating or cooling. The exception is that the cutback values will never be returned less than $1.6 \cdot PB$.

17.5.14 Failure Modes

The conditions for performing an autotune are monitored by the parameter 'State' (Tune folder). If autotune is not successful error conditions are read by this parameter as follows:-

Timeout	This will occur if any one stage is not completed within one hour. It could be due to the loop being open or not responding to the demands from the controller. Very heavily lagged systems may produce a timeout if the cooling rate is very slow.
TI Limit	This will be displayed if Autotune calculates a value for the integral term greater than the maximum allowable integral setting i.e. 99999 seconds. This may indicate that the loop is not responding or that the tune is taking too long.
R2G Limit	The calculated value of R2G is outside the range 0.1 and 10.0. In versions up to and including V2.3, R2G is set to 0.1 but all other PID parameters are updated. R2G limit may occur if the gain difference between heating and cooling is too large. This could also occur if the controller is configured for heat/cool but the cooling medium is turned off or not working correctly. It could similarly occur if the cooling medium is on but heating is off or not working correctly.

17.5.15 Manual Tuning

If for any reason automatic tuning gives unsatisfactory results, you can tune the controller manually. There are a number of standard methods for manual tuning. The one described here is the Ziegler-Nichols method.

Adjust the setpoint to its normal running conditions (it is assumed this will be above the PV so that heat only is applied)

Set the Integral Time 'Ti' and the Derivative Time 'Td' to 'OFF'.

Set High Cutback 'CBH' and Low Cutback 'CBL' to 'Auto'.

Ignore the fact that the PV may not settle precisely at the setpoint.

If the PV is stable, reduce the proportional band so that the PV just starts to oscillate. Allow enough time between each adjustment for the loop to stabilise. Make a note of the proportional band value 'PB' and the period of oscillation 'T'. If PV is already oscillating measure the period of oscillation 'T', then increase the proportional band until it just stops oscillating. Make a note of the value of the proportional band at this point.

Set the proportional band, integral time and derivative time parameter values according to the calculations given in the table below:-

Type of control	Proportional band (PB)	Integral time (Ti) seconds	Derivative time (Td) seconds
Proportional only	2xPB	OFF	OFF
P + I control	2.2xPB	0.8xT	OFF
P + I + D control	1.7xPB	0.5xT	0.12xT

17.5.16 Manually Setting Relative Cool Gain

If the controller is fitted with a cool channel this should be enabled before the PID values, calculated from the table above, are entered.

Observe the oscillation waveform and adjust R2G until a symmetrical waveform is observed.

Then enter the values from the table.

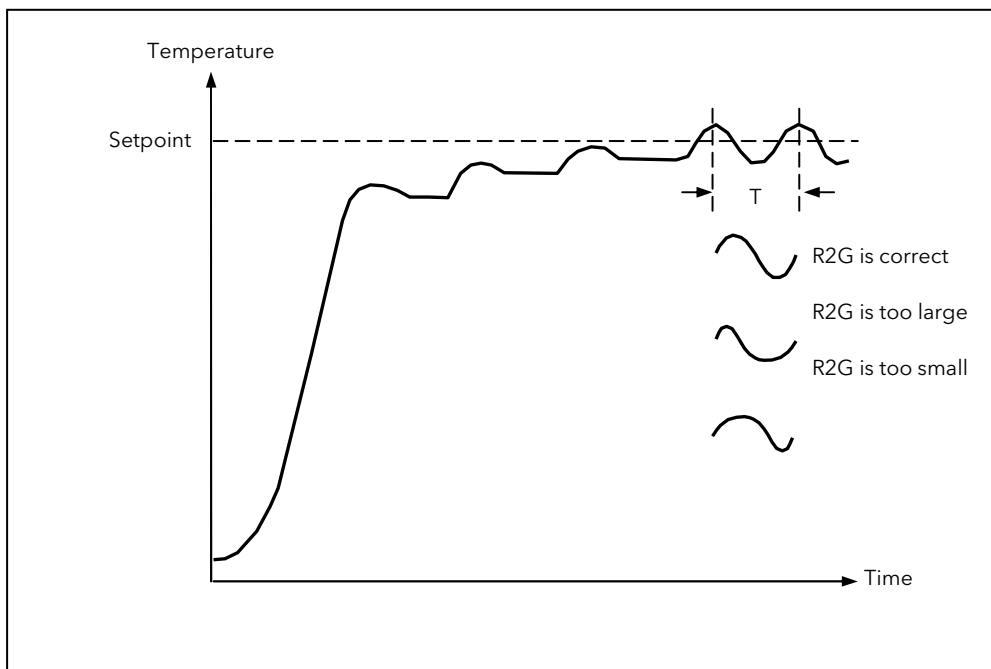

Figure 17-10: Setting Relative Cool Gain

17.5.17 Manually Setting the Cutback Values

Enter the PID terms calculated from the table in section 17.5.15 before setting cutback values.

The above procedure sets up the parameters for optimum steady state control. If unacceptable levels of overshoot or undershoot occur during start-up, or for large step changes in PV, then manually set the cutback parameters.

Proceed as follows:

Initially set the cutback values to one proportional bandwidth converted into display units. This can be calculated by taking the value in percentage that has been installed into the parameter 'PB' and entering it into the following formula:-

$PB/100 * \text{Span of controller} = \text{Cutback High and Cutback Low}$

For example, if PB = 10% and the span of the controller is 0 - 1200°C, then

Cutback High and Low = $10/100 * 1200 = 120$

If overshoot is observed following the correct settings of the PID terms increase the value of 'CBL' by the value of the overshoot in display units. If undershoot is observed increase the value of the parameter 'CBH' by the value of the undershoot in display units.

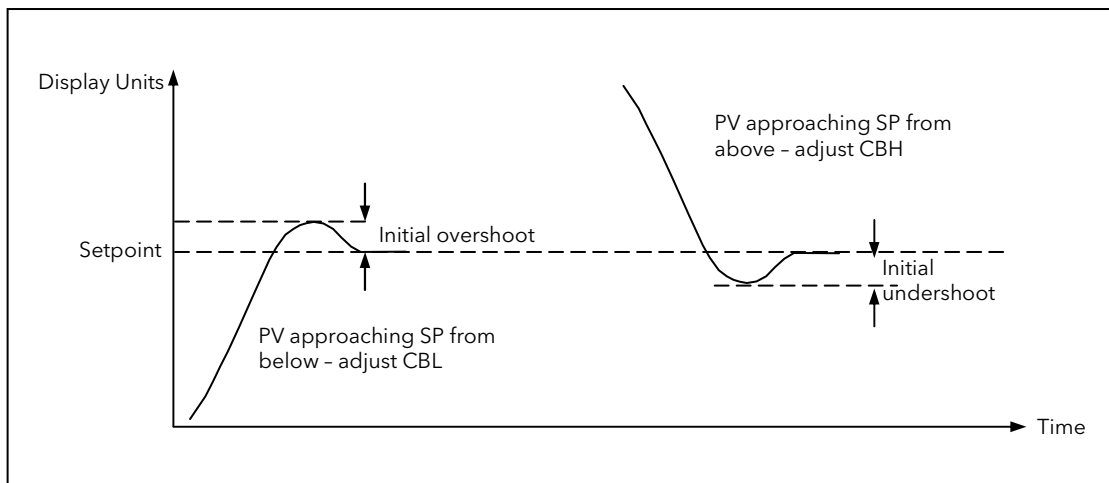

Figure 17-11: Manual Setting of Cutback

17.6 Setpoint Function Block

For each of the 16 loops, the controller setpoint is the **Working Setpoint** that may come from a number of alternative sources. This is the value ultimately used to control the process variable in each loop.

The working setpoint may be derived from:-

1. SP1 or SP2, both of which are individually set, can be selected by an external signal or via the SPSelect parameter over communications.
2. From an external (remote) analogue source
3. The output of a programmer function block and will, therefore, vary in accordance with the program in use.

The setpoint function block also provides the facility to limit the rate of change of the setpoint before it is applied to the control algorithm. It will also provide upper and lower limits. These are defined as setpoint limits for the local setpoints and instrument range high and low for other setpoint sources. All setpoints are ultimately subject to a limit of range hi and range lo.

User configurable methods for tracking are available, such that the transfer between setpoints and between operational modes will not cause a bump in the setpoint.

17.6.1 Setpoint Function Block

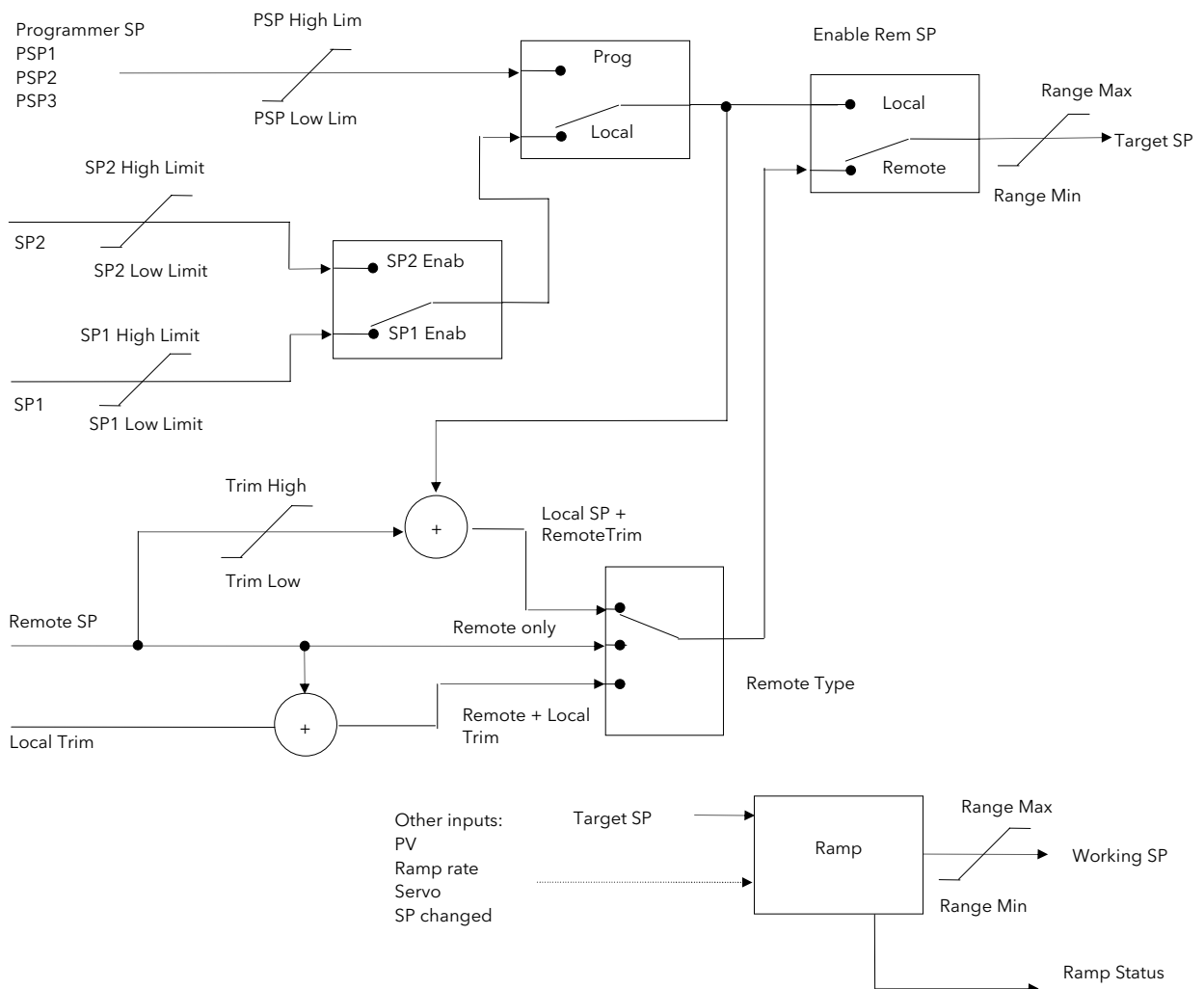

Figure 17-12: Setpoint Function Block

17.6.2 SP Tracking

When setpoint tracking is enabled and the local setpoint is selected, the local setpoint is copied to 'TrackSP'. Tracking now ensures that the alternate SP follows or tracks this value. When the alternate setpoint is selected it initially takes on the tracked value thus ensuring that no bump takes place. The new setpoint is then adopted gradually. A similar action takes place when returning to the local setpoint.

17.6.3 Manual Tracking

When the controller is operating in manual mode the currently selected SP tracks the PV. When the controller resumes automatic control there will be no step change in the resolved SP.

17.6.4 Rate Limit

Rate limit will control the rate of change of setpoint. It is enabled by the '**Rate**' parameter. If this is set to Off then any change made to the setpoint will be effective immediately. If it is set to a value then any change in the setpoint will be effected at the value set in units per minute. Rate limit also acts on SP2 and when switching between SP1 and SP2.

When rate limit is active the '**RateDone**' parameter will display '**No**'. When the setpoint has been reached this parameter will change to '**Yes**'.

When '**Rate**' is set to a value (other than Off) an additional parameter '**SPRate Disable**' is displayed which allows the setpoint rate limit to be turned off and on without the need to adjust the 'Rate' parameter between Off and a value.

17.6.5 Setpoint Parameters

Folder - Loop.1 to Loop.16		Sub-folder: SP			
Name	Parameter Description	Value		Default	Access Level
Range High	The Range limits provide a set of absolute maximums and minimums for setpoints within the control loop. Any derived setpoints are ultimately clipped to be within the Range limits. If the Proportional Band is configured as % of Span, the span is derived from the Range limits.	Full range of the input type			Conf
Range Low					Conf
SP Select	Select local or alternate setpoint	SP1 SP2	Setpoint 1 Setpoint 2	SP1	Oper
SP1	Primary setpoint for the controller	Between SP high and SP low limits			Oper
SP2	Setpoint 2 is the secondary setpoint of the controller. It is often used as a standby setpoint.				Oper
SP HighLimit	Maximum limit allowed for the local setpoints	Between Range Hi and Range Lo			Oper
SP LowLimit	Minimum limit allowed for the local setpoints				Oper
Alt SP Select	To enable the alternative setpoint to be used. This may be wired to a source such as the programmer Run input.	No Yes	Alternative setpoint disabled Alternative setpoint enabled		Oper
Alt SP	This may be wired to an alternative source such as the programmer or remote setpoint				Oper
Rate	Limits the maximum rate at which the working setpoint can change. The rate limit may be used to protect the load from thermal shock which may be caused by large step changes in setpoint.	Off or 0.1 to 9999.9 engineering units per minute		Off	Oper
RateDone	Flag which indicates when the setpoint is changing or completed	No Yes	Setpoint changing Complete		R/O
Rate Disable	Setpoint rate disable	No Yes	Enabled Disabled		Oper

Folder - Loop.1 to Loop.16		Sub-folder: SP			
Name	Parameter Description	Value		Default	Access Level
ServoToPV	Servo to PV Enable When Rate is set to any value other than Off and Servo to PV is enabled, changing the active SP will cause the working SP to servo to the current PV before ramping to the new target SP.	No Yes	Disabled Enabled	No	Conf R/O in L3
SP Trim	Trim is an offset added to the setpoint. The trim may be either positive or negative, the range of the trim may be restricted by the trim limits Setpoint trims may be used in a retransmission system. A master zone may retransmit the setpoint to the other zones, a local trim may be applied to each zone to produce a profile along the length of the machine	Between SP Trim Hi and SP Trim Lo			Oper
SPTrim HighLimit	Setpoint trim high limit				Oper
SPTrim LowLimit	Setpoint trim low limit				Oper
ManualTrack	To enable manual tracking. When the loop is switched from Manual to Auto, the Setpoint is set to the current PV. This is useful if the load is started in Manual Mode, then later switched to Auto to maintain the operating point.	Off On	Manual tracking disabled Manual tracking enabled		R/O
SP Track	Setpoint tracking ensures bumpless transfer in setpoint when switching between a local and an alternate setpoint such as the programmer. This enables the tracking interface provided by TrackPV and TrackVal, which is used by the programmer and other setpoint providers external to the control loop	Off On	Setpoint tracking disabled Setpoint tracking enabled		Conf
Track PV	The programmer tracks the PV when it is servoing or tracking.				R/O
Track SP	Manual Tracking Value. The SP to track for manual tracking.				R/O
SPIntBal	SP Integral Balance This is also known as debump in some instances. It forces the integral to be balanced upon changes in target setpoint	Off On		Off	L3 R/O Alterable in config

17.6.6 Setpoint Limits

The setpoint generator provides limits for each of the setpoint sources as well as an overall set of limits for the loop. These are summarised in the diagram below.

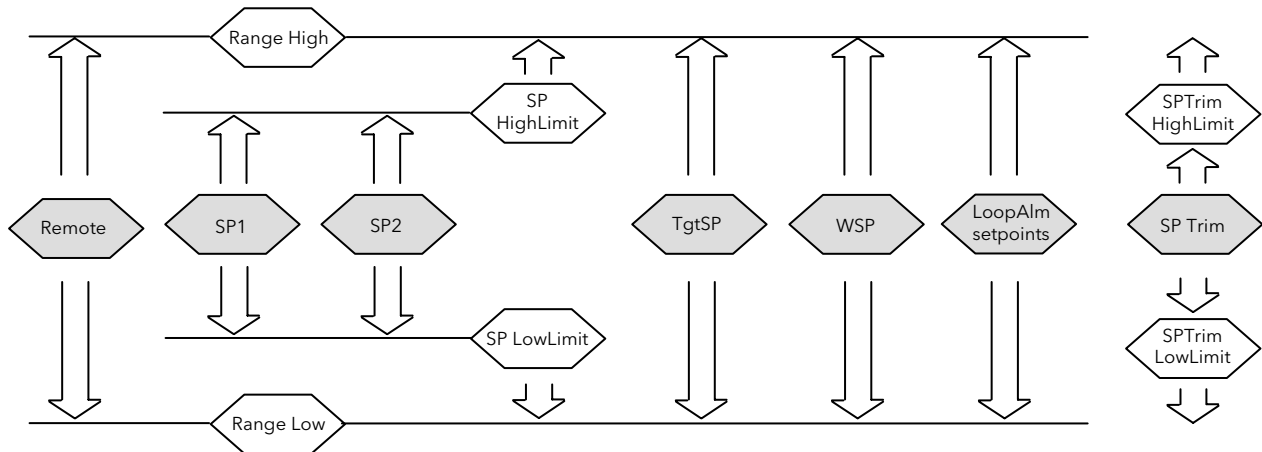

Figure 17-13: Setpoint Limits

- ☺ **'Range High'** and **'Range Low'** provide the range information for the control loop. They are used in control calculations to generate proportional bands. $\text{Span} = \text{Range High} - \text{Range Low}$.

17.6.7 Setpoint Rate Limit

Allows the rate of change of setpoint to be controlled. This prevents step changes in the setpoint. It is a simple symmetrical rate limiter and is applied to the working setpoint which includes setpoint trim. It is enabled by the **'Rate'** parameter. If this is set to Off then any change made to the setpoint will be effective immediately. If it is set to a value then any change in the setpoint will be effected at the value set in units per minute. Rate limit applies to SP1, SP2 and Remote SP.

When rate limit is active the **'RateDone'** flag will display **'No'**. When the setpoint has been reached this parameter will change to **'Yes'**. This flag will be cleared if the target setpoint subsequently changes.

When **'Rate'** is set to a value (other than Off) an additional parameter **'Rate Disable'** is displayed which allows the setpoint rate limit to be turned off and on without the need to adjust the **'Rate'** parameter between Off and a value.

If the PV is in sensor break, the rate limit is suspended and the working setpoint takes the value of 0. On sensor break being released the working setpoint goes from 0 to the selected setpoint value at the rate limit.

17.6.8 Setpoint Tracking

The setpoint used by the controller may be derived from a number of sources. For example:-

1. Local setpoints SP1 and SP2. These may be selected using the parameter 'SP Select' in the SP folder, through digital communications or by configuring a digital input which selects either SP1 or SP2. This might be used, for example, to switch between normal running conditions and standby conditions. If Rate Limit is switched off the new setpoint value is adopted immediately when the switch is changed.
2. A programmer generating a setpoint which varies over time, see Chapter 18. When the programmer is running the 'Track SP' and 'Track PV' parameters update continuously so that the programmer can perform its own servo (see also section 18.7.1). This is sometimes referred to as '**Program Tracking**'.
3. From a Remote analogue source. The source could be an external analogue input into an analogue input module wired to the 'Alt SP' parameter or a User Value wired to the 'Alt SP' parameter. The remote setpoint is used when the parameter 'Alt SP Select' is set to 'Yes'.

Setpoint tracking (sometimes referred to as **Remote Tracking**) ensures that the Local setpoint adopts the Remote setpoint value when switching from Local to Remote to maintain bumpless transfer from Remote to Local. Bumpless transfer does not take place when changing from Local to Remote. Note, that if Rate Limit is applied the setpoint will change at the rate set when changing from Local to Remote.

17.6.9 Manual Tracking

When the controller is operating in manual mode the currently selected SP (SP1 or SP2) tracks the PV. When the controller resumes automatic control there will be no step change in the resolved SP. Manual tracking does not apply to the remote setpoint or programmer setpoint.

17.7 Output Function Block

The output function block allows you to set up output conditions from the control block, such as output limits, hysteresis, output feedforward, behaviour in sensor break, etc.

Folder - Loop.1 to Loop.16		Sub-folder: OP			
Name	Parameter Description	Value		Default	Access Level
Output High Limit	Maximum output power delivered by channels 1 and 2. By reducing the high power limit, it is possible to reduce the rate of change of the process, however, care should be taken as reducing the power limit will reduce the controllers ability to react to disturbance.	Between Output Lo and 100.0%		100.0	Oper
Output Low Limit	Minimum (or maximum negative) output power delivered by channels 1 and 2	Between Output Hi and -100.0%		-100.0	
Ch1 Out	Channel 1 (Heat) output. The Ch1 output is the positive power values (0 to Output Hi) used by the heat output. Typically this is wired to the control output (time proportioning or DC output).	Between output Hi and Output Lo			R/O
Ch2 Out	The Ch2 output is negative portion of the control output (0 - Output Lo) for heat/cool applications. It is inverted to be a positive number so that it can be wired into one of the outputs (time proportioning or DC outputs).	Between output Hi and Output Lo			R/O
Ch2 DeadBand	Ch1/Ch2 Deadband is a gap in percent between output 1 going off and output 2 coming on and vice versa. For on/off control this is taken as a percentage of the hysteresis.	Off to 100.0%		Off	Oper
Rate	Limits the rate at which the output from the PID can change in % change per minute. Output rate limit is useful in preventing rapid changes in output from damaging the process or the heater elements.	Off to 9999.9 percent per minute		Off	Oper
Rate Disable	Output rate disable	No Yes	Enabled Disabled		Oper
Ch1 OnOff Hysteresis	Channel hysteresis only shown when channel 1 is configured as OnOff.	0.0 to 200.0		10.0	Oper
Ch2 OnOff Hysteresis	Hysteresis sets the difference between output on and output off to prevent (relay) chatter.	0.0 to 200.0		10.0	Oper
SensorBreak Mode	Defines the action taken if the Process Variable is bad, i.e. the sensor has failed. This can be configured as hold, in which case the output of the loop is held at its last good value. Alternately the output can switch to a safe output power defined at configuration.	Safe Hold	To select the level set by 'Safe OP' To hold the current output level at the point when sensor break occurs	Safe	Oper
Safe OP Val	Sets the output level to be adopted when loop is inhibited	Between output Hi and Output Lo		0	Oper

Folder - Loop.1 to Loop.16		Sub-folder: OP			
Name	Parameter Description	Value		Default	Access Level
SbrkOp	Sets the output level to be adopted when in sensor break condition.	Between output Hi and Output Lo		0	Oper
Manual Mode	Selects the mode of manual operation.	Track	In auto the manual output tracks the control output such that a change to manual mode will not result in a bump in the output.		Oper
		Step	On transition to manual the output will be the manual op value as last set by the operator.		
ManualOutVal	The output when the loop is in manual. Note: In manual mode the controller will still limit the maximum power to the power limits, however, it could be dangerous if the instrument is left unattended at a high power setting. It is important that the over range alarms are configured to protect your process. <i>We recommend that all processes are fitted with an independent over range "policeman"</i>	Between output Hi and Output Lo			R/O
ForcedOP	Forced manual output value. When 'Man Mode' = 'Step' the manual output does not track and on transition to manual the target output will step from its current value to the 'ForcedOP' value.	-100.0 to 100.0		0.0	Oper
Cool Type	Selects the type of cooling channel characterisation to be used. Can be configured as water, oil or fan cooling.	Linear Oil Water Fan	These are set to match the type of cooling medium applicable to the process		Conf
FeedForward Type	Feedforward type The following four parameters appear if FF Type ≠ None	None	No signal fed forward	None	Conf
		Remote	A remote signal fed forward		
		SP	Setpoint fed forward		
		PV	PV fed forward		
FeedForward Gain	Defines the gain of the feedforward value, the feed forward value is multiplied by the gain				Conf
FeedForward Offset	Defines the offset of the feedforward value this is added to the scaled feedforward.				Oper
FeedForward Trim Limit	Feedforward trim limits the effect of the PID output. Defines symmetrical limits around the PID output, such that this value is applied to the feedforward signal as a trim.				Oper

Folder - Loop.1 to Loop.16		Sub-folder: OP			
Name	Parameter Description	Value		Default	Access Level
FF_Rem	Remote Feedforward signal. Allows an another signal to be used as Feedforward.	This is not affected by FeedForward Gain or Offset			R/O
FeedForward Val	The calculated Feedforward Value.				R/O
TrackOutVal	Value for the loop output to track when OP Track is Enabled.				
Track Enable	When enabled, the output of the loop will follow the track output value. The loop will bumplessly return to control when tracking is turned off.	Off On	Disabled Enabled		Oper
RemOPL	Remote output low limit. Can be used to limit the output of the loop from a remote source or calculation. This must always be within the main limits.	-100.0 to 100.0			Oper
RemOPH	Remote output high limit	-100.0 to 100.0			Oper

17.7.1 Output Limits

The diagram shows where output limits are applied.

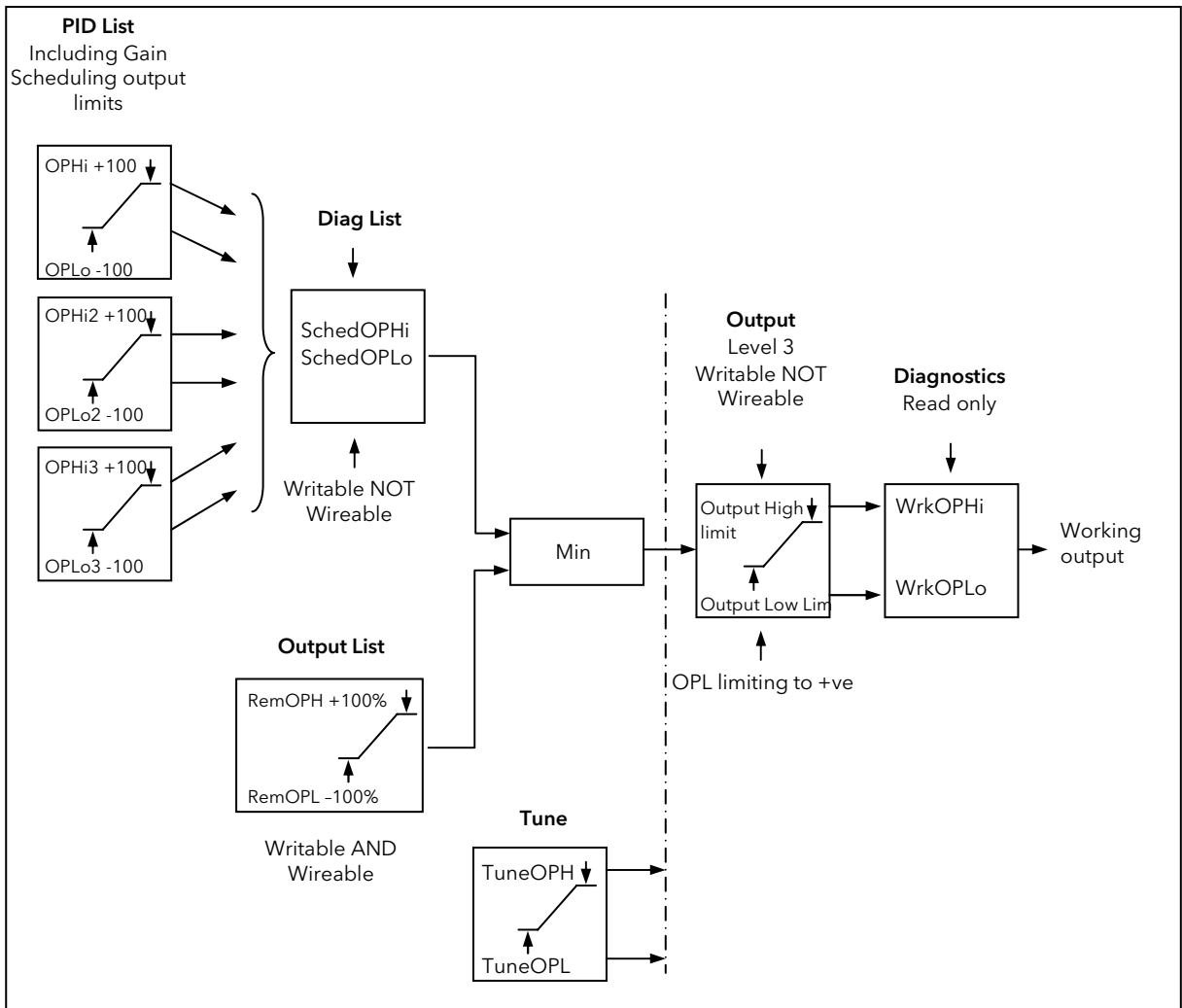

Figure 17-14: Output Limits

- Individual output limits may be set in the PID list for each set of PID parameters when gain scheduling is used.
- The parameters 'SchedOPHi' and 'SchedOPHLo', found the Diagnostics folder, may be set to values which override the gain scheduling output values.
- A limit may also be applied from an external source. These are 'RemOPH' and 'RemOPLo' (Remote output high and low) found in the Output folder. These parameters are wireable. For example they may be wired to an analogue input module so that a limit may applied through some external strategy. If these parameters are not wired $\pm 100\%$ limit is applied every time the instrument is powered up.
- The tightest set (between Remote and PID) is connected to the output where an overall limit is applied using parameters 'Output High Limit' and 'Output Low Limit' settable in Oper Level.
- 'Wrk OPHi' and 'Wrk OPHLo' found in the Diagnostics folder are read only parameters showing the overall working output limits.

The tune limits are a separate part of the algorithm and are applied to the output during the tuning process. The overall limits 'Output High Limit' and 'Output Low Limit' always have priority.

17.7.2 Output Rate Limit

The output rate limiter is a simple rate of change limiter which will prevent the control algorithm demanding step changes in output power. It may be set in percent per minute.

The rate limit is performed by determining the direction in which the output is changing, and then incrementing or decrementing the Working Output ('ActiveOut' in the Main folder) until 'ActiveOut' = the required output.

The amount by which to increment or decrement will be calculated based on the sampling rate of the algorithm (i.e. 110ms) and the rate limit that has been set. If the change in output is less than the rate limit increment the change will take effect immediately.

The rate limit direction and increment will be calculated on every execution of the rate limit. Therefore, if the rate limit is changed during execution, the new rate of change will take immediate effect. If the output is changed whilst rate limiting is taking place, the new value will take immediate effect on the direction of the rate limit and in determining whether the rate limit has completed.

The rate limiter is self-correcting such that if the increment is small and is lost in the floating point resolution, the increment will be accumulated until it takes effect.

The output rate limit will remain active even if the loop is in manual mode

17.7.3 Sensor Break Mode

Sensor break is detected by the measurement system and a flag is passed to the control block which indicates sensor failure. On the loop being informed that a sensor break has occurred it may be configured using '**SensorBreak Mode**' to respond in one of two ways. The output may go to a pre-set level or remain at its current value.

The pre-set value is defined by the parameter '**SbrkOP**'. If rate limit is not configured the output will step to this value otherwise it will ramp to this value at the rate limit.

If configured as '**Hold**' the output of the loop will stay at its last good value. If Output Rate Limit (Rate) has been configured a small step may be seen as the working output will limit to the 2 second old value.

On exit from sensor break the transfer is bumpless - the power output will ramp from its pre-set value to the control value.

17.7.4 Forced Output

This feature enables the user to specify what the output of the loop should do when moving from automatic control to manual control. The default is that the output power will be maintained and is then editable by the user. If forced manual is enabled, two modes of operation can be configured. The forced manual step setting means the user can set a manual output power value and on transition to manual the output will be forced to that value. If '**Track Enable**' is enabled the output steps to the forced manual output and then subsequent edits to the output power are tracked back into the manual output value.

The parameters associated with this feature are '**ForcedOP**' and '**ManualMode**' = '**Step**'.

17.7.5 Feedforward

Feedforward is a value, which is scaled and added to the PID output, before any limiting. It can be used for the implementation of cascade loops or constant head control. Feedforward is implemented such that the PID output is limited to trim limits and acts as a trim on a FeedForward Value. The FeedForward Val is derived either from the PV or setpoint by scaling the PV or SP by the 'FeedForward Gain' and 'FeedForward Offset'. Alternatively, a remote value may be used for the FeedForward Val, this is not subject to any scaling. The resultant FeedForward Val is added to the limited PID OP and becomes the PID output as far as the output algorithm is concerned. The feedback value then generated must then have the FF contribution removed before being used again by the PID algorithm. The diagram below shows how feedforward is implemented

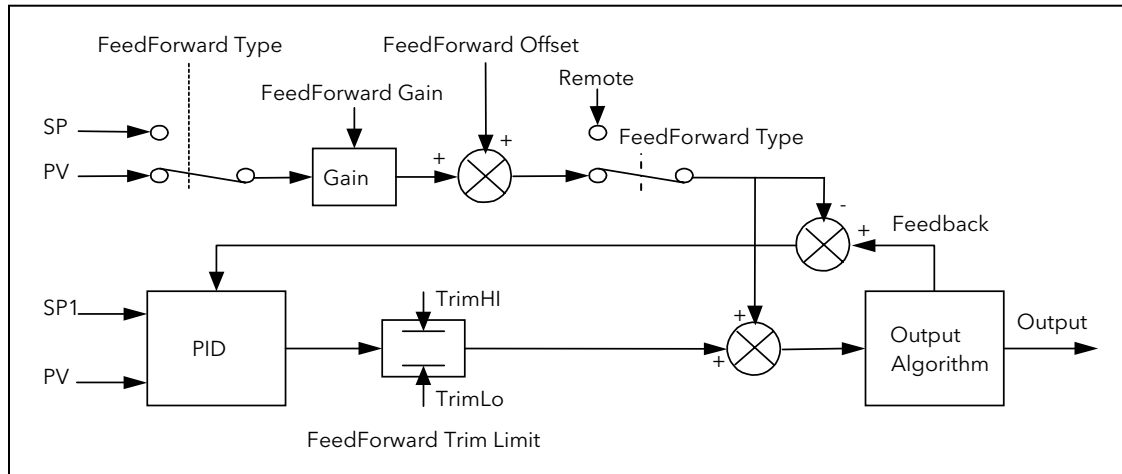

Figure 17-15: Implementation of Feedforward

17.7.6 Effect of Control Action, Hysteresis and Deadband

For temperature control 'Loop.1.Control Action' will be set to 'Reverse'. For a PID controller this means that the heater power decreases as the PV increases. For an on/off controller output 1 (usually heat) will be on (100%) when PV is below the setpoint and output 2 (usually cool) will be on when PV is above the setpoint

Hysteresis applies to on/off control only. It defines the difference in temperature between the output switching off and switching back on again. The examples below show the effect in a heat/cool controller.

Deadband (Ch2 DeadB) can operate on both on/off control or PID control where it has the effect of widening the period when no heating or cooling is applied. However, in PID control its effect is modified by both the integral and derivative terms. Deadband might be used in PID control, for example, where actuators take time to complete their cycle thus ensuring that heating and cooling are not being applied at the same time. Deadband is likely to be used, therefore, in on/off control only. The second example below adds a deadband of 20 to the above example.

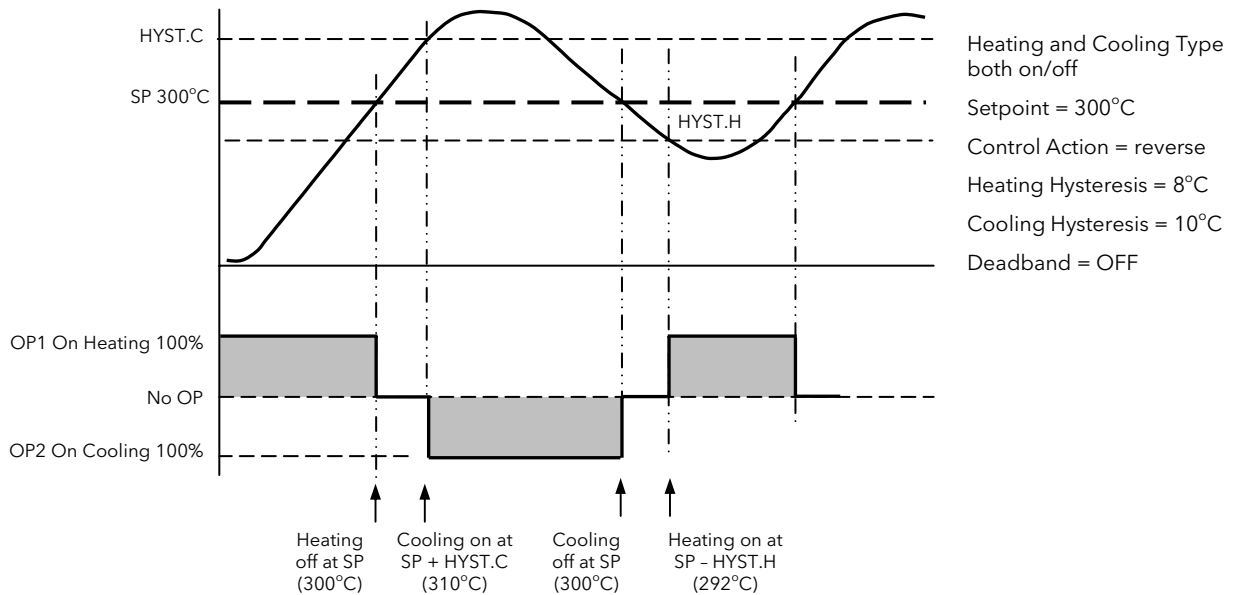

Figure 17-16: Deadband OFF

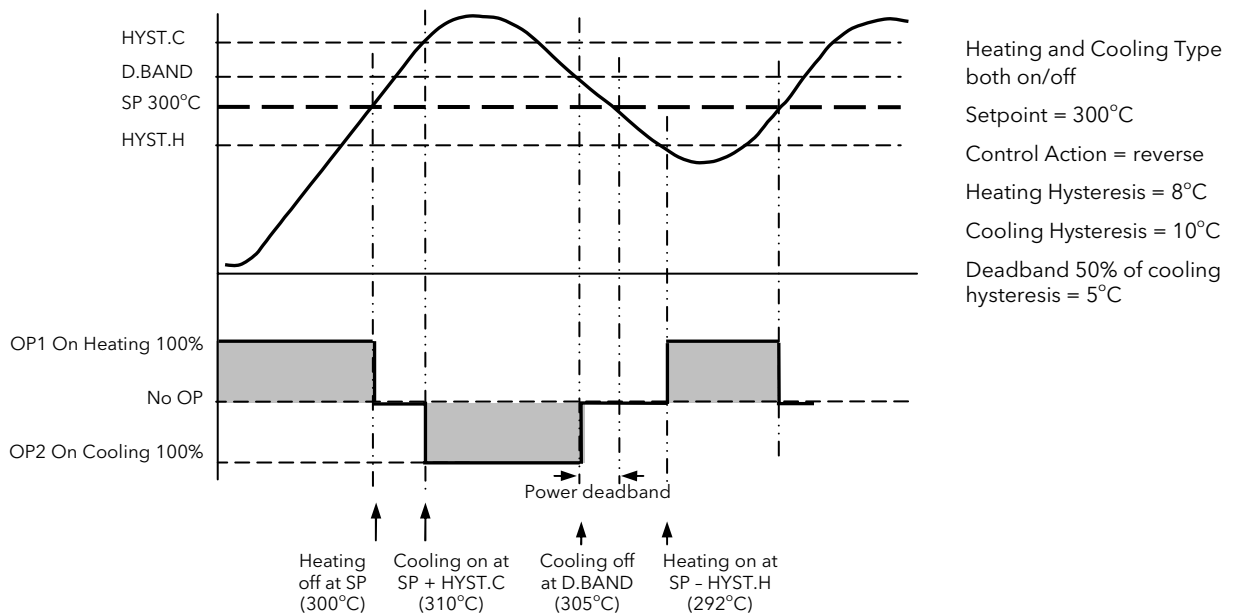

Figure 17-17: Deadband ON set at 50% of Cooling. Hysteresis = 5°C

18. Chapter 18 Setpoint Programmer

18.1 INTRODUCTION

In a setpoint programmer you can set up a profile in the controller in which the setpoint varies in a pre-determined way over a period of time. Temperature is a very common application where it is required to 'ramp' the process value from one level to another over a set period of time.

The **Program** is divided into a flexible number of **Segments** - each being of a single time duration.

It is often necessary to switch external devices at particular times during the program. Up to eight digital 'event' outputs can be programmed to operate during those segments.

An example of a program and two event outputs is shown below.

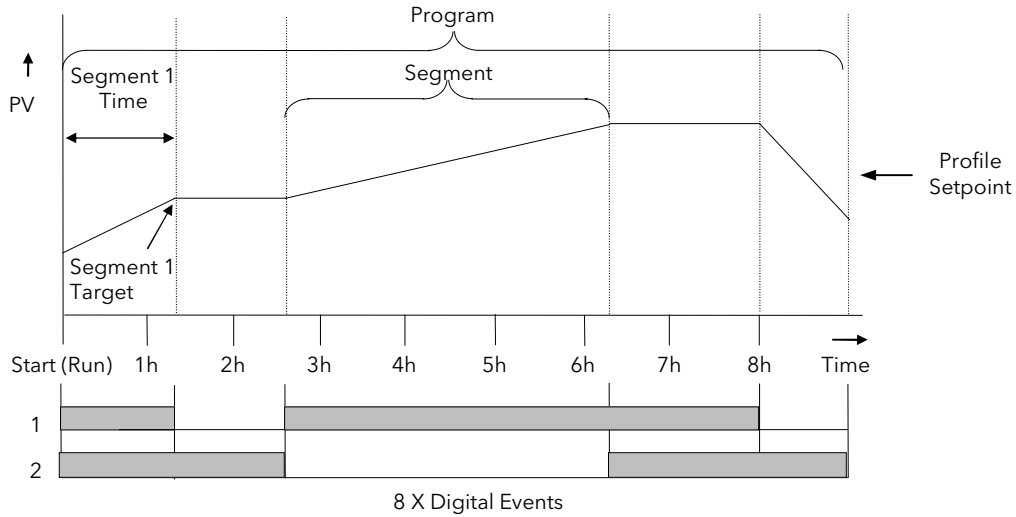

Figure 18-1: A Setpoint Program

18.1.1 Time to Target Programmer

Each segment consists of a **single duration parameter** and a set of **target values** for the profiled variables.

1. The **duration** specifies the time that the segment takes to change the profiled variables from their current values to the new targets.
2. A **dwell** type segment is set up by leaving the target setpoint at the previous value.
3. A **Step** type segment is set up by setting the segment time to zero.

A program with all segments configured as Time-to-Target is shown below.

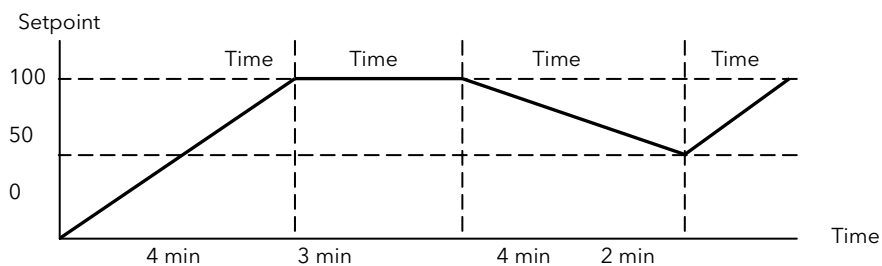

Figure 18-2: Time to Target Programmer

18.1.2 Ramp Rate Programmer

A ramp rate programmer specifies its ramp segments as maximum setpoint changes per time unit.

Each segment can be specified by the operator as **Ramp Rate, Dwell or Step**.

1. Ramp Rate - the setpoint changes at a rate in units/time
2. Dwell - the time period is set - there is no need to set the target value as this is inherited from the previous segment
3. Step - specify target setpoint only - the controller will use that setpoint when the segment is reached

The diagram below shows an example of a ramp rate programmer.

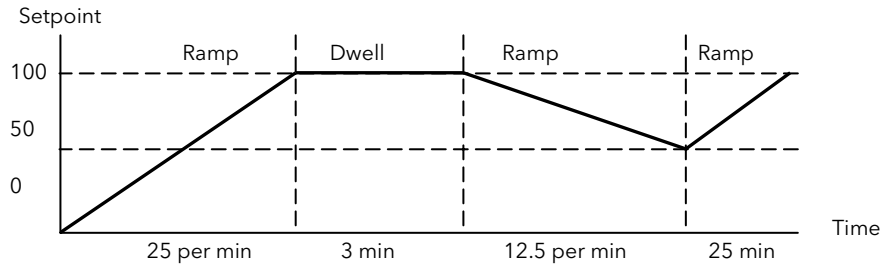

Figure 18-3: Ramp Rate Programmer

18.2 Mini8 Controller Programmer Block(s)

Mini8 Controller Version 2.xx have **8** programmer blocks available. Each of these blocks has **one** program of up to **16** segments. One block may be wired to all 16 loops or up to 8 loops may have their own programmer block. In this situation Loop 1, Programmer block 1 and program 1 are associated together, Loop 2, Programmer block 2 and program 2 are associated together, and so on up to Loop 8, Programmer block 8 and program 8 being associated together.

Mini8 Controller Version 1.xx have a single programmer block. The total number of segments available is **200** or **50 per program** and it is possible to store up to **50 separate programs**. Parameter tables of this version are included in Appendix D.

Note: Version 1.xx Mini8 controller clone files with programs included will not load correctly into a version 2.xx Mini8.

18.3 Segment Types

Depending on the type of program configured, a segment may be set as:-

18.3.1 Rate

A Ramp segment provides a controlled change of setpoint from an original to a target setpoint. The duration of the ramp is determined by the rate of change specified. Two styles of ramp are possible in the range, Ramp-Rate or Time-To-Target.

The segment is specified by the target setpoint and the desired ramp rate. The ramp rate parameter is presented in engineering units ($^{\circ}\text{C}$, $^{\circ}\text{F}$, Eng.) per real time units (Seconds, Minutes or Hours). If the units are changed, all ramp rates are re-calculated to the new units and clipped if necessary

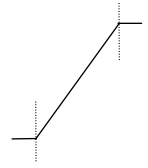

18.3.2 Dwell

The setpoint remains constant for a specified period at the specified target. The operating setpoint of a dwell is inherited from the previous segment.

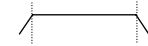

18.3.3 Step

The setpoint changes instantaneously from its current value to a new value at the beginning of a segment. A Step segment has a minimum duration of 1 second.



18.3.4 Time

A time segment defines the duration of the segment. In this case the target setpoint is defined and the time taken to reach this value. A dwell period is set by making the target setpoint the same value as the previous setpoint.

18.3.5 GoBack

Go Back allows segments in a program to be repeated a set number of times. The diagram shows an example of a program which is required to repeat the same section a number of times and then continue the program.

When planning a program it is advisable to ensure that the end and start setpoints of the program are the same otherwise it will step to the different levels. A Go Back segment is defined when editing a program.

'Goback Seg' specifies the segment to go back to

'Goback Cycles' specifies the number of times the goback loop is executed

Overlapping Goback loops are disallowed

Note 1. If a second or more 'Go Back' segments are created, they cannot return to a segment before the previous 'Go Back' segment as shown.

In this diagram a Go Back segment can be created from 3 to 2 or 1. Go Back segments can also be created from 7 to 6 or 5 or 4 but not from 7 to 2 or 1

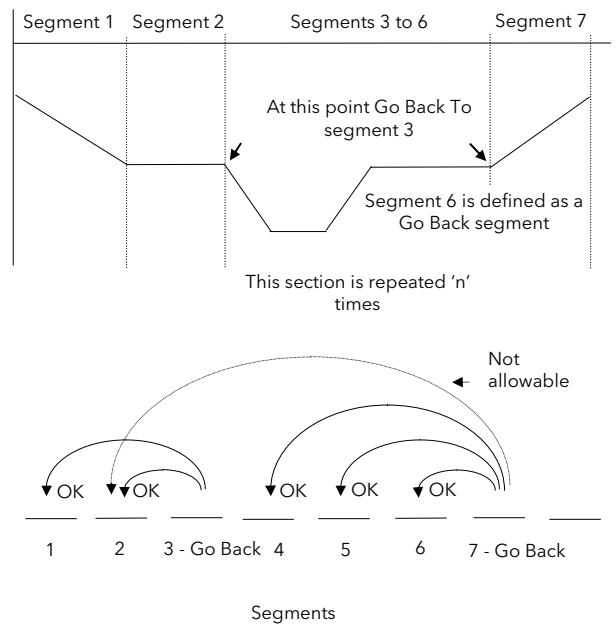

18.3.6 Wait

Wait specifies the criterion for which a segment cannot proceed to the next segment. Any segment can be defined as 'Wait' in the 'Program Edit' page. The next parameter is then '**Wait For**' and here you define the criterion.

'Wait For' criteria:-

- None No action
- PrgIn1 Wait until Input 1 is true
- PrgIn2 Wait until Input 2 is true
- PrgIn1n2 Wait until Input 1 AND Input 2 are true
- PrgIn1or2 Wait until Input 1 OR Input 2 is true

PVWaitIP Wait until PV has met the criteria against the parameter '**WaitVal**' as shown:

'Wait For' set to 'PVWaitIP' PSP = 100 'WaitVal' = 5	
PVWait	Segment will wait until
Abs Hi	PVWaitIP >= 5
Dev Lo	PVWaitIP >= 95
Abs Lo	PVWaitIP <= 5
Dev Hi	PVWaitIP <= 105

Example where the temperature must have reached 550 °C before the program continues:

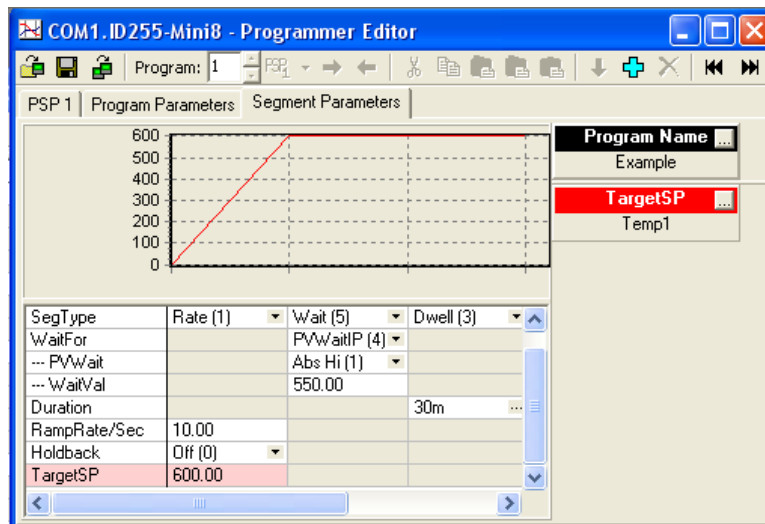

This and subsequent screen shots are from the Programmer editor in iTools.

Wait segments do not have Events or Holdback.

18.3.7 End

A program may contain one End segment. This allows the program to be truncated to the number of segments required.

The end segment can be configured to have an indefinite dwell at the last target setpoint or to reset to the start of the program or to go to a defined level of power output (SafeOP). This is selectable by the user.

If a number of program cycles are specified for the program, then the End segment is not executed until the last cycle has completed

18.4 Output Events

Program segments have configurable events. 'Wait' 'GoBack' and 'End' segments do not have events. There are up to 8 digital events, PV Events and Time Events.

18.4.1 Digital Events

These are digital flags which can be set on or off for each of the segments.

These are enabled by setting Programmer.n.Setup.MaxEvents to the required maximum number of events (>0 and <=8).

	1	2	3
SegType	Rate (1) ▾	Dwell (3) ▾	Step (4) ▾
Duration		30m ...	
RampRate/Min	600.00		
Holdback	Off (0) ▾		Off (0) ▾
TargetSP	600.00		0.00
GSoakType		Low (1) ▾	
... GSoakVal		5.00	
PIDSet	Set1 (1) ▾	Set2 (2) ▾	Set1 (1) ▾
EventOuts

Clicking the icon on the right in an 'EventOuts' cell opens digital events window:

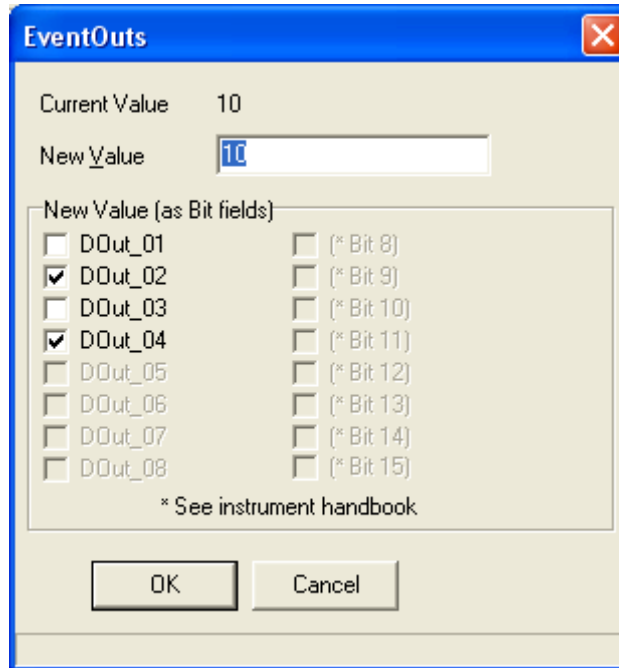

In this example Programmer.n.Setup.MaxEvents has been set to 4. Tick the boxes of the outputs that are required. The value shown is the bit mask for the outputs (10 = 2 + 8 i.e. outputs 2 and 4)

The EventOuts row above shows this setup for each segment.

18.4.2 PV Event & User Value

PV Events are essentially a simplified analogue alarm per segment based on the programmer PV input. For this feature the Programmer.n.Setup.EnablePVEvent must be set to 'Yes'. The PV Event Output (PVEventOP) may be used to trigger the required response.

- Each Segment has one *PV Event Type* (*Off, Hi, Lo, Dev Hi, Dev Lo, Dev Band**)
- Each Segment has one *PV Threshold*

* Dev refers to deviation of the PV parameter from Programmer Setpoint (i.e. there is no reference input).

If the **PVEvent** type is set to *None* in a segment then the User value may be used as a general purpose analogue value per segment. For this feature the Programmer.n.Setup.EnableUValue must be set to 'Yes'. By default, the parameter is named '**UserVal**' - it may be renamed in Programmer.n.Setup.UValName.

	1	2	3
SegType	Rate (1)	Wait (5)	Dwell (3)
WaitFor		PVWaitIP (4)	
... PVWait		None (0)	
Duration			30m
RampRate/Sec	10.00		
Holdback	Off (0)		
TargetSP	600.00		
PVEvent	None (0)		Dev Band (5)
... PVThreshold			0.00
UserVal	0.00		

In segment 1 there is no PVEvent so the UserVal may be set but in segment 3 the PVEvent type is not 'None' so only the PVThreshold may be set.

The event output is Programmer.n.Setup.PVEventOP, the UserVal output is Programmer.n.Setup.UserValOP

18.4.3 Time Event

Digital events can simply be the turning on of a digital output for the duration of a segment. An extension of this is the Time Event. For this feature Programmer.n.Setup.MaxEvents must be > 0 and the Programmer.n.Setup.EnableTimeEvent must be set to 'Yes'. In this case the first digital event Event1 can have a delay (On Time) and an (Off Time) specified. 'On Time' defines when the digital output will turn on after the beginning of the segment and 'Off Time' defines when the digital output will turn off. The reference point for the On and Off times is the **start of the segment**.

- Only the first digital event **Event1** may be configured as a Time Event.
- Each segment has one Time Event parameter (OFF, Event1).
- The first digital event cannot be set (read only if TimeEvent is not OFF).

The following example of a timed event in segment 3 shows that Programmer.n.Setup.EventOut1 will be on for 10 minutes during segment 3 starting 10 minutes after segment 3 begins.

	1	2	3
SegType	Rate (1)	Wait (5)	Dwell (3)
WaitFor		PVWaitIP (4)	
--- PVWait		None (0)	
Duration			30m ...
RampRate/Sec	10.00		
Holdback	Off (0)		
TargetSP	600.00		
TimeEvent	Off (0)		Event1 (1)
--- OnTime			10m ...
--- OffTime			20m ...
EventOuts

Editing of the Time Events follows a number of simple rules to make programming easier for the operator - these are shown in the 3 diagrams below:

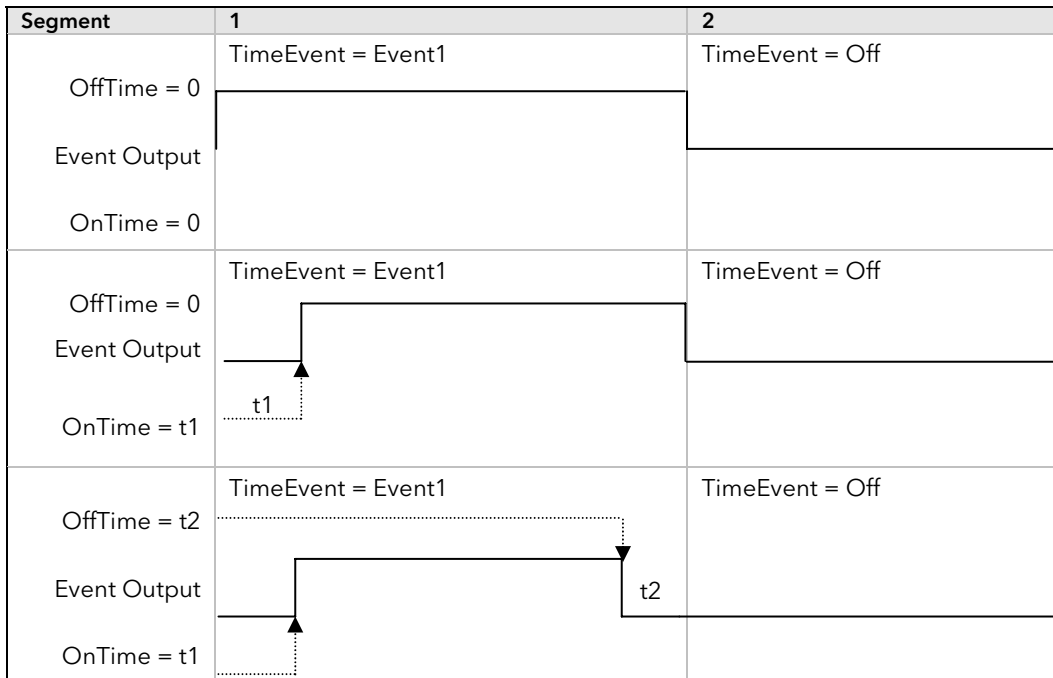

Segment	1	2
OffTime	TimeEvent = Event1 OffTime * = 0	TimeEvent = On OffTime
Event Output		OnTime=0
OnTime		
OffTime	Time Event = Event1	Time Event = Off
Event Output		
OnTime = 0		
OffTime	Time Event = Event1	TimeEvent = Off
Event Output	Error : OffTime > segment 1 duration 	
OnTime		

- To configure an event which straddles two segments configure Ton in Segment n and Toff in segment n+1.

Segment	1	2
OffTime	Time Event = Event1	Time Event = Off
OnTime	Error : OnTime = OffTime 	
Event Output Off		
OffTime	Time Event = Event1	Time Event = Off
OnTime	Error : OnTime > OffTime 	
Event Output Off		
OffTime	Time Event = Event1	Time Event = Off
OnTime	Error : OnTime > seg 1 duration 	
Event Output Off		

OnTime and OffTime are extended by G.Soak periods. If OnTime = 0, the output goes hi at the start of the segment but OffTime is not decremented while Gsoak Wait is applied. Timed event outputs are on a total of Gsoak Wait + (OffTime - OnTime).

In the event of a power fail, time events timing will be unaffected.

18.5 Holdback

Holdback freezes the program if the process value (PV) does not track the setpoint (SP) by more than a user defined amount. The programmer will remain in HOLDBACK until the PV returns to within the requested deviation from setpoint.

In a Ramp it indicates that the PV is lagging the SP by more than the set amount and that the program is waiting for the process to catch up.

Holdback maintains the correct soak period for the product – see Guaranteed Soak below.

Each program can be configured with a holdback value. Each segment determines the holdback function.

Holdback will cause the execution time of the program to extend, if the process cannot match the demanded profile.

Holdback state will not change access to the parameters. The parameters will behave as if in the RUN state.

The diagram below demonstrates that the demanded setpoint (SP) will only change at the rate specified by the program when the PV's deviation is less than the holdback value. When the Deviation between the setpoint and PV is greater than the holdback value (HBk Val) the setpoint ramp will pause until the deviation returns to within the band.

The next segment will not start until the deviation between Setpoint and PV is less than the holdback value.

Four types of Holdback are available:-

None Holdback is disabled for this segment.

High Holdback is entered when the PV is greater than the Setpoint **plus** HBk Val.

Low Holdback is entered when the PV is lower than the Setpoint **minus** HBk Val.

Band Holdback is entered when the PV is **either** greater than the Setpoint **plus** HBk Val **or** lower than the Setpoint **minus** HBk Val

18.5.1 Guaranteed Soak

Guaranteed Soak (guaranteed time workpiece stays at SP within a specified tolerance) is achieved in the previous single programmer version by using Holdback Band during a dwell segment. Since only one holdback value per program is available, this imposes a limitation where different tolerance values are required to guarantee the soak.

In 2.xx Mini8 controller Holdback Type in Dwell segments is replaced by a Guaranteed Soak Type (G.Soak) which can be set as Off, Lo, Hi or Band. A Guaranteed Soak Value (G.Soak Val) is available in Dwell segments and this provides the ability to set different values in any Dwell segment.

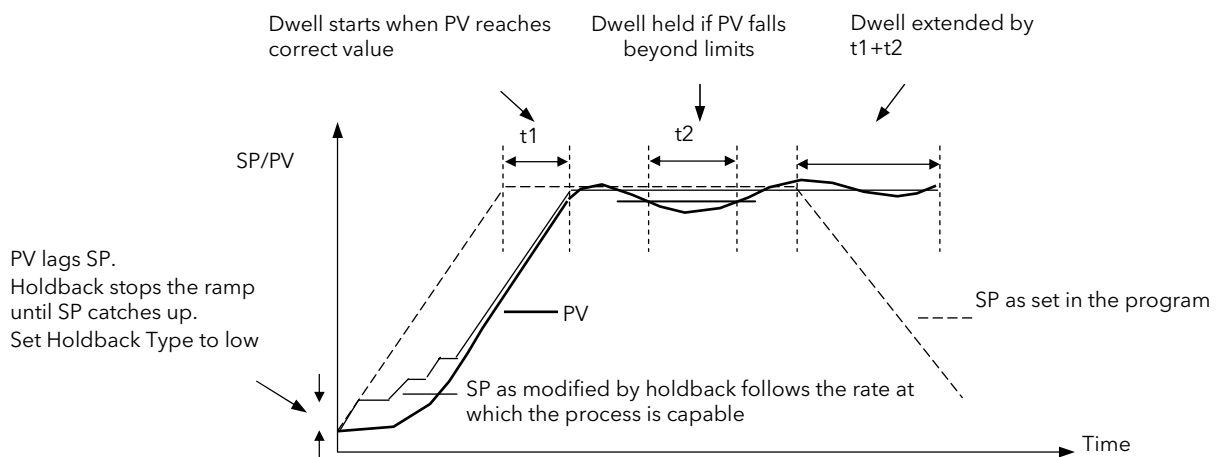

18.6 PID Select

It is possible to set up three sets of PID values, see section 17.4.9. Any one of these sets may be activated in any segment of the program, except if the segment is configured as Wait, Goback or End. For this feature Programmer.n.Setup.EnablePIDSched must be set to 'Yes'. The last PID set in the program (SET1 by default) will be applied during these segments. When reset the usual PID strategy for the loop takes over.

In the following example the ramp uses PID set 1 and the dwell uses PID set 2.

It also shows that the segment 2 dwell guarantees that the PV will be above 595 °C for the full 30 minutes.

	1	2	3
SegType	Rate (1) ▾	Dwell (3) ▾	Step (4) ▾
Duration		30m ...	
RampRate/Sec	10.00		
Holdback	Off (0) ▾		Off (0) ▾
TargetSP	600.00		0.00
GSoakType		Low (1) ▾	
--- GSoakVal		5.00	
PIDSet	Set1 (1) ▾	Set2 (2) ▾	Set1 (1) ▾
EventOuts

18.7 Program Cycles

If the Program Cycles parameter is chosen as greater than 1, the program will execute all its segments then repeat from the beginning. The number of cycles is determined by the parameter value. The Program Cycles parameter has a range of 0 to 999 where 0 is enumerated to CONTinuous.

18.7.1 Servo

Servo can be set in configuration so that when a program is run the setpoint can start from the initial controller setpoint or from the current process value. Whichever it is, the starting point is called the servo point. This can be set in the program.

Servo to PV will produce a smooth and bumpless start to the process.

Servo to SP may be used in a Ramp Rate programmer to guarantee the time period of the first segment. (Note: in a Time to Target programmer the segment duration will always be determined by the setting of the Segment Duration parameter.)

18.8 Power Fail Recovery

In the event of power fail to the Mini8 controller, a strategy may be set in configuration level, which defines how the controller behaves on restoration of the power.

The action on power failure is selecte3d using Programmer.n.Setup.PowerFailAct and offers:

Ramp	This will servo the program setpoint to the measured value (the PV Input parameter value), then return to the target setpoint at the current (or previous) ramp rate. (Default). The setpoint is not allowed to step change the program setpoint. The outputs will take the state of the segment which was active before power was interrupted. See examples below.
Reset	The process is aborted by resetting the program. All event outputs will take the reset state.
Continue	The program setpoint returns immediately to its last value prior to the power down. This may cause full power to be applied to the process for a short period to heat the process back to its value prior to the power failure.

18.8.1 Ramp (Power fail during Dwell segments.)

If the interrupted segment was a Dwell, then the ramp rate will be determined by the previous ramp segment.

On achieving the Dwell setpoint, the dwell will continue from the point at which the power was interrupted.

Note: If a previous ramp segment does not exist, i.e. the first segment of a program is a dwell, then the Dwell will continue at the "servo to PV" setpoint.

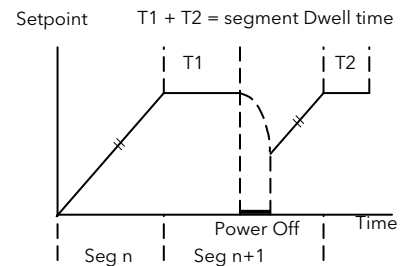

18.8.2 Ramp (power fail during Ramp segments)

If the interrupted segment was a ramp, then the programmer will servo the program setpoint to the PV, then ramp towards the target setpoint at the previous ramp rate. Previous ramp rate is the ramp rate at power fail.

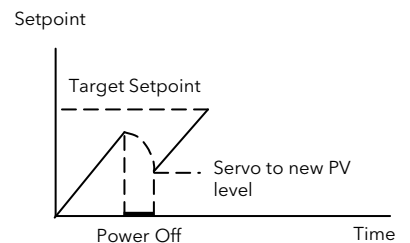

18.8.3 Ramp (power fail during Time-to-target segments)

If the programmer was defined as a Time-to-Target programmer then when the power is returned the previous ramp rate will be recovered. The Time remaining will be recalculated. The rule is to maintain RAMP RATE, but alter TIME REMAINING.

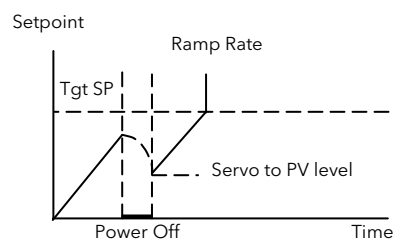

18.9 To Run, Hold or Reset a Program

The program is operated via parameters found in the Program Setup lists, Programmer.n.Setup.ProgRun, .ProgReset, .ProgHold, .ProgRunReset and .ProgRunHold. These parameters can be wired to digital inputs or written to over comms.

The status of the program is in Program.n.Run.ProgStatus

18.9.1 Run

A program will always run - non configured programs will default to a single Dwell end segment. In run the programmer working setpoint varies in accordance with the profile set in the active program. Parameters are Programmer.n.Setup.ProgRun or Programmer.n.Setup.ProgRunReset.

ProgRun runs the program when input goes from false to true.

ProgRunReset runs the program if true, resets it if false.

18.9.2 Reset

In reset the programmer is inactive and the controller behaves as a standard controller. It will:-

1. Continue to control with the setpoint determined by the next available source, SP1, SP2, Alternative Setpoint.
2. Allow edits to all segments
3. Return all controlled outputs to the configured reset state.

Parameters are Programmer.n.Setup.ProgReset or Programmer.n.Setup.ProgRunReset.

ProgReset resets the program when input goes from false to true.

ProgRunReset resets the program if false, runs it if true.

18.9.3 Hold

A programmer may only be placed in Hold from the Run or Holdback state. In hold the setpoint is frozen at the current programmer setpoint and the time remaining parameter frozen at its last value. In this state you can make temporary changes to program parameters such as a target setpoint, ramp rates and times. These changes will only remain effective until the end of the currently running segment, when they will be overwritten by the stored program values.

Parameters are Programmer.n.Setup.ProgHold or Programmer.n.Setup.ProgRunHold.

ProgHold holds the program when input goes from false to true.

ProgRunHold runs the program if true, holds it if false.

18.9.4 Skip segment

Skip jumps immediately to the beginning of next segment and starts that segment from the current setpoint value.

Parameter is Programmer.n.Setup.SkipSeg and will skip to next segment when input goes from false to true.

18.9.5 Advance segment

Advance sets the program setpoint equal to the target setpoint and moves to the next segment.

Parameter is Programmer.n.Setup.AdvSeg and will advance to next segment when input goes from false to true.

18.9.6 Fast

Executes the program at 10x the normal speed. It is provided so that programs can be tested **but the process should not be run in this state.**

Parameter is Programmer.n.Run.FastRun .

18.10 PV Start

When Run is initiated PV start (for each channel) allows the program to automatically advance to the correct point in the profile which corresponds to the current PV. For example, if the process is already at PV3 when run is initiated then the program will start from the third segment as shown in the diagram below.

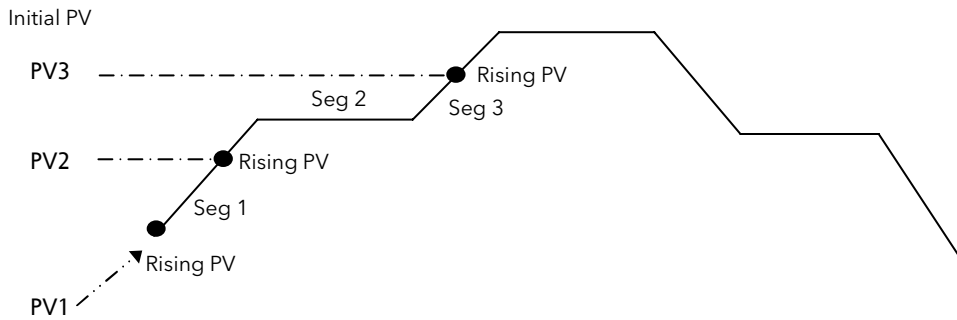

The user may specify the start point based on a Rising PV as shown in the diagram above or on a Falling PV as shown below depending on type of profile being run.

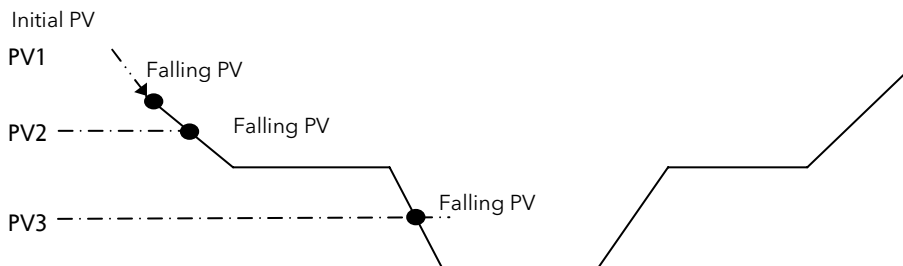

When PV Start is used, the program always servos to PV (i.e. servo to SP will be ignored).

PV Start is enabled by setting parameter Instrument.Options.ProgPVstart to 'Yes'.

18.11 Configuring the Programmer

Programmer.n.Setup contains the general configuration settings for the Programmer Block and the parameters used to operate the programmer.

Programs are created and stored in the **Program** Folder.

The Programmer status can be viewed using the parameters in the **Programmer.n.Run** folder.

The program can also be operated by setting the **Programmer.n.Run.ProgStatus** parameter to the required state.

Folder - Programmer.1 to .8		Sub-folder: Setup			
Name	Parameter Description	Value		Default	Access Level
SyncIn	The synchronise input is a way of synchronising programs. At the end of a segment the programmer will inspect the sync. input, if it is True (1) then the programmer will advance to the next segment. It is typically wired from the end of segment output of another programmer. Only appears if 'SyncMode' = 'Yes'	0 1	This will normally be wired to the 'End of Seg' parameter.		Oper
Units	Units of the Output			None	Conf
Resolution	Programmer Output resolution	X to X.XXXX		X	Conf
RateResolution	Ramp Rate Resolution	X to X.XXXX		X.X	Conf
PVIn	The programmer uses the PV input for a number of functions In holdback, the PV is monitored against the setpoint, and if a deviation occurs the program is paused. The programmer can be configured to start its profile from the current PV value (servo to PV). The programmer monitors the PV value for Sensor Break. The programmer holds in sensor break.	The PV Input is normally wired from the loop TrackPV parameter. Note: This input is automatically wired when the programmer and loop are enabled and there are no existing wires to track interface parameters. Track interface parameters are Programmer.Setup, PVInput, SPInput, Loop.SP, AltSP, Loop.SP, AltSPSelect.			Conf
SPIn	The programmer needs to know the working setpoint of the loop it is trying to control. The SP input is used in the servo to setpoint start type.	SP Input is normally wired from the loop Track SP parameter as the PV input.			Conf
Servo	The transfer of program setpoint to PV Input (normally the Loop PV) or the SP Input (normally the Loop setpoint).	PV SP	See also section 18.7.1.		Conf
PowerFailAct	Power fail recovery strategy	Ramp Reset Cont	See section 18.8		Conf
Max Events	To set the maximum number of output events required for the program. This is for convenience to avoid having to scroll through unwanted events when setting up each segment	1 to 8			Conf
EnablePVEvent	Enable PV Event provides an alarm facility on Programmer's PVInput. PV Event Type and Threshold are defined in each Segment.	No Yes	PV Event parameters are listed in the Program Edit page.	No	Conf

Folder - Programmer.1 to .8		Sub-folder: Setup			
Name	Parameter Description	Value		Default	Access Level
EnableTime Event	Enables the first Event Output to be configured as a Time Event - each segment may then specify an on and an off time, with respect to the start of the segment, for the event.	No		No	Conf
		Yes	Time Event parameters are listed in the Program Edit page		
EnableUserVal	Enables a single analogue value to be set in every segment. It is only available if Ch1/Ch2Event = None in the Program Edit page.	No	User value not shown	No	Conf
		Yes	User value shown in every segment		
UValName	User Value Name			UserVal	Conf
EnableGsoak	Enable Guaranteed soak ensures that the work piece remains at the specified dwell setpoint for a minimum of the specified duration. This parameter is only shown for SyncStart programmers	No	No guaranteed	No	Conf
		Yes	Guaranteed soak parameters are listed in the Program Edit page for all Dwell segments.		
Enable DelayedStart	Enables a time period to be set between starting Run and the program actually running	No	The program will run immediately	No	Conf
		Yes	Delayed start is listed in the Program Status page. It is also listed in the pop up associated with the RUN/HOLD key.		
Enable PID Set	Enables PID set. The setting configured in each segment will automatically select the relevant PID Set for the loop wired to the Programmer. Upon completion of the program, PID setting of the loop will be reset to values prior to execution of the program	No	Each segment uses the same PID values	No	Conf
EnableImmPSP	Enable immediate PSP			No	
Prog Reset	Resets program on transition to true	No/Yes	Can be wired from logic inputs to provide remote program control	Yes	Oper
Prog Run	Runs program on transition to true	No/Yes		No	Oper
Prog Hold	Holds program on transition to true	No/Yes		No	Oper
ProgRunHold	Program runs if true Program holds if false	No/Yes		No	Oper
ProgRunReset	Program runs if true Program holds if false	No/Yes		No	Oper
AdvSeg	Set output to target setpoint and advance to next segment	No/Yes			Oper
SkipSeg	Skip to the next setpoint and start the segment at the current output value.	No/Yes			Oper
PrgIn1 & 2	Programmer Digital Input 1 and 2 These are events and can be wired to any parameter. They are used in 'wait' segments to prevent the program continuing until the event becomes true	Off/On	Used in Wait segment	off	

Folder - Programmer.1 to .8		Sub-folder: Setup			
Name	Parameter Description	Value		Default	Access Level
EventOut1 to 8	Flags showing event states	No/Yes			R/O
End of Seg	Flag showing end of segment state	No/Yes			R/O
ProgError	Program Error	0 No error 1 Sensor Break 2 Empty Program 3 Overrange			R/O

18.12 Programmer Run Status

The 'Run' folder shows the current program status. The program can also be operated by setting the ProgStatus parameter to the required state.

Folder - Programmer.1 to .8		Sub-folder: Run		
Name	Parameter Description	Value	Default	Access Level
CurProg	Current Program Number	1	1	R/O
DelayedStart	Time for Delayed start. Enabled in Programmer.n.Setup.EnableDelayed Start	hh:mm:ss	0	Oper
CurrSeg	Current Running Segment	1 to 255	1	R/O
ProgStatus	Program Status	Reset - Run - Hold - Holdback - End -		Oper
CurSegType	Current Segment type	End Rate Time Dwell Step Call	End	R/O
PSP	Programmer Setpoint		0	R/O
CyclesLeft	Number of Cycles Remaining	0 to 1000	0	R/O
SegTimeLeft	Segment Time Remaining	Hr Min Sec Millisec	0	R/O
SegDuration	Time remaining to end of segment			R/O
SegTarget	Current Target Setpoint Value			R/O
SegRate	Segment Ramp Rate	0.1 to 9999.9	0	R/O
ProgTimeLeft	Program Time Remaining	Hrs Min Sec Millisec	0	R/O
CyclesLeft	Number of cycles remaining			R/O
Goback CyclesLeft	Number of go back cycles left			R/O
FastRun	Fast Run	No (0) Normal Yes (1) Program executes at 10 times real time	No	Oper
EndOutput	End Output	Off (0) Program not in End On (1) Program at End	Off	R/O
EventsOut	Event Outputs	0 to 255, each bit represents an output.	0	R/O
ResetEventOuts	Reset Event Outputs	0 to 255, each bit resets its corresponding output	0	Oper
ResetUVal	Reset User Value			

18.13 Creating a Program

A folder exists for each Program containing a few key parameters listed below. This folder would normally be viewed via the iTools Program Editor under the Program Parameters tab. The Program Editor is used to create the segments of Program itself using the Segment Editor tab.

Folder - Program		Sub-folder: 1 to 50			
Name	Parameter Description	Value		Default	Access Level
Name	Program Name	Up to 8 characters		Null	Oper
Holdback Value	Deviation between SP and PV at which holdback is applied. This value applies to the whole program.	Minimum setting 0		0	Oper
Ramp Units	Time units applied to the segments	Sec Min Hour	Seconds Minutes Hours	sec	Oper
Cycles	Number of times the whole program repeats	Cont (0) 1 to 999	Repeats continuously Program executes once to 999 times	1	Oper

18.14 Program Editor

The Program Editor in iTools provides the method of entering and editing programs directly in the controller. Setpoint programs can be created graphically, stored and downloaded into the controller. From the iTools menu select 'Program Editor OR Press  Programmer to create/edit a Program.

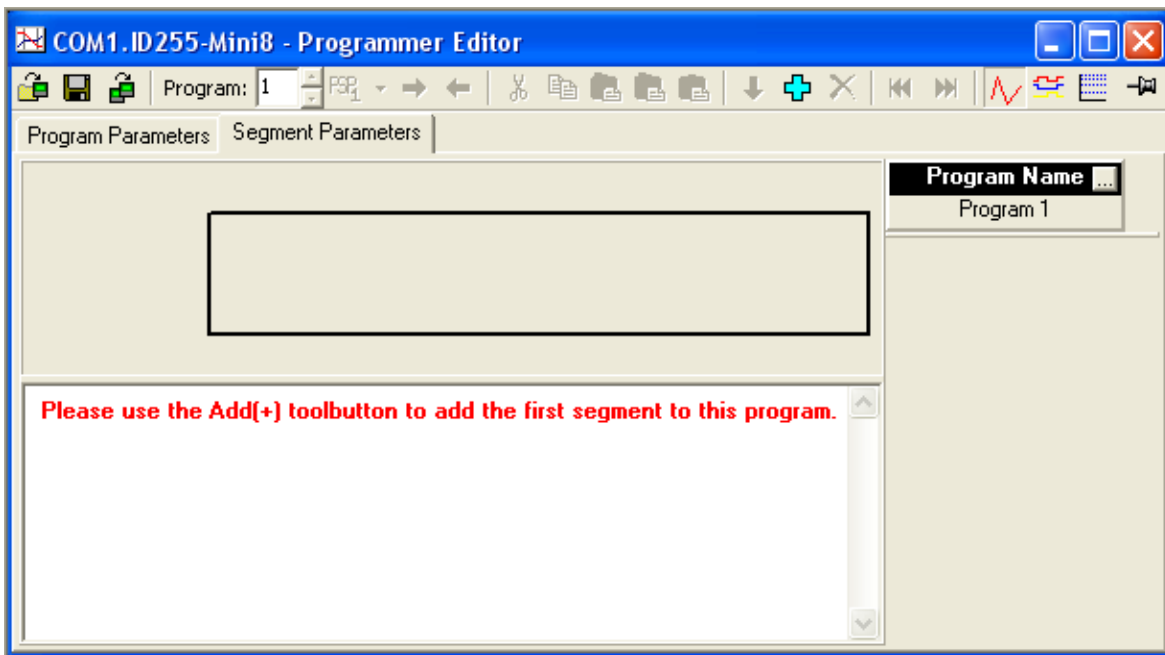

Figure 18-4: Blank Programmer editor - use + or Right Click to add segment

18.14.1 Analog View



This view is used for editing the analogue setpoints.

1. Select a program number using **Program:** [dropdown] - 1 in this example.
2. Double click **Program Name** [dropdown] and enter a name for the program - "Example"
3. Double click **TargetSP** [dropdown] and enter a name for the TargetSP - "Temperature"
4. Right click in the blank area and choose 'Add Segment'

Segment Type	Description	Parameters	Values
End	Ends Program	Reset	Reset - returns to Loop setpoint Dwell - remains at final setpoint SafeOP - goes to SafeOP value
Rate	Ramp at a rate	Target SP Ramp rate	SP range 0.1 - 9999.9
Time	Ramp to a target over an interval	Target SP Duration	SP range hh:mm:ss
Dwell	Soak at a fixed SP	Duration	hh:mm:ss
Wait	Waits for an event	Wait For	In 1 PrgIn1 In 2 PrgIn2 In1 AND In 2 PrgIn1n2 In1 OR In 2 PrgIn1or2 PV wait PVWaitIP

5. Use the drop down to select segment type. Each segment type has the necessary parameters to suit.
6. Right click to insert more segments. End with an 'End' segment.

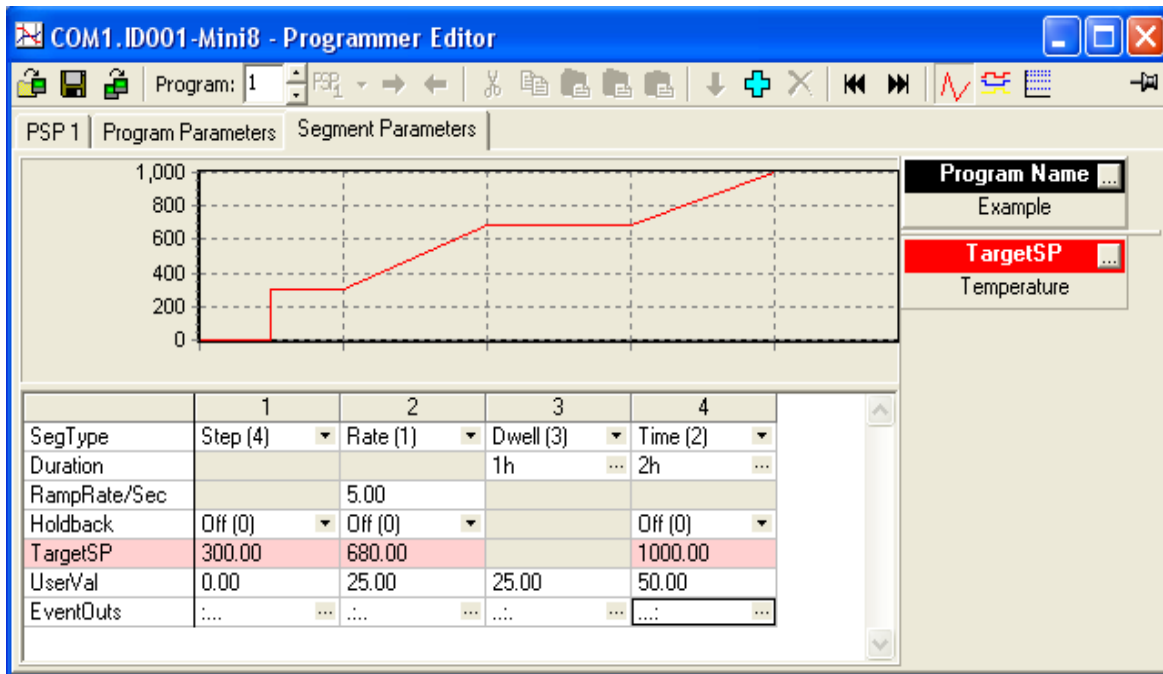

Figure 18-5: Spreadsheet Editor with 4 different segment types

Note PSP1 tab shown in Config mode.
 This tab displays all the parameters in Programmer.1.Setup folder.
 With 8 Programmers enabled 8 PSP tabs would be shown.

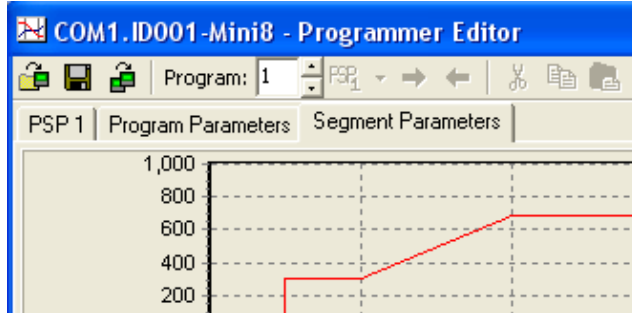

Figure 18-6: PSP tabs

- Click on 'EventOuts' to set up the event outputs for each segment. Note only 4 events have been enabled.

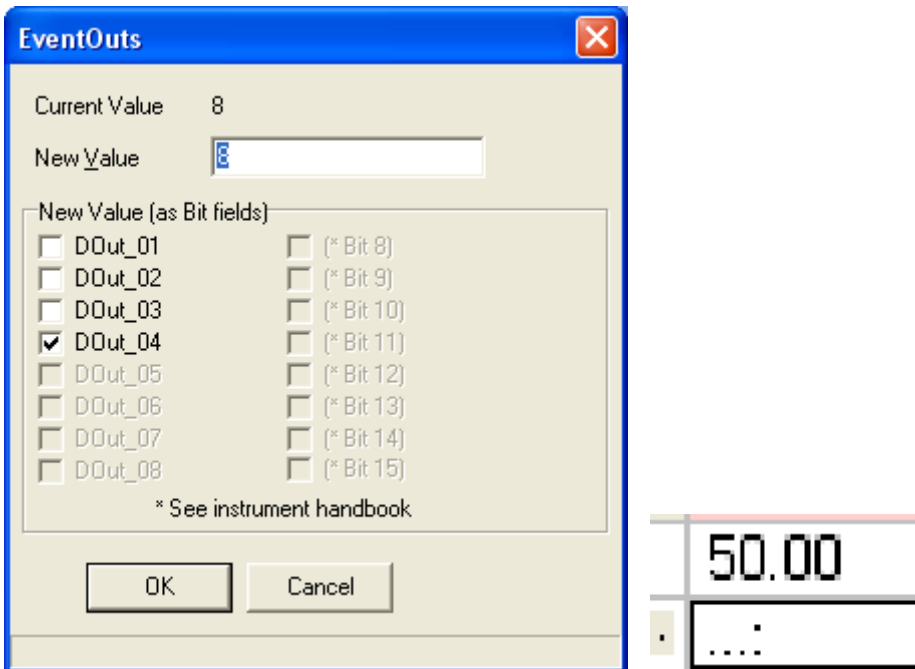

Figure 18-7: EventOuts with Out 4 set

In the Example program, the dots in EventOuts show which are on in each segment - O/P 1 in segment 1, O/P in segment 2 etc.

18.14.2 Digital View



Alternatively click the icon and the Digital Editor is shown (or hit Cntrl D)

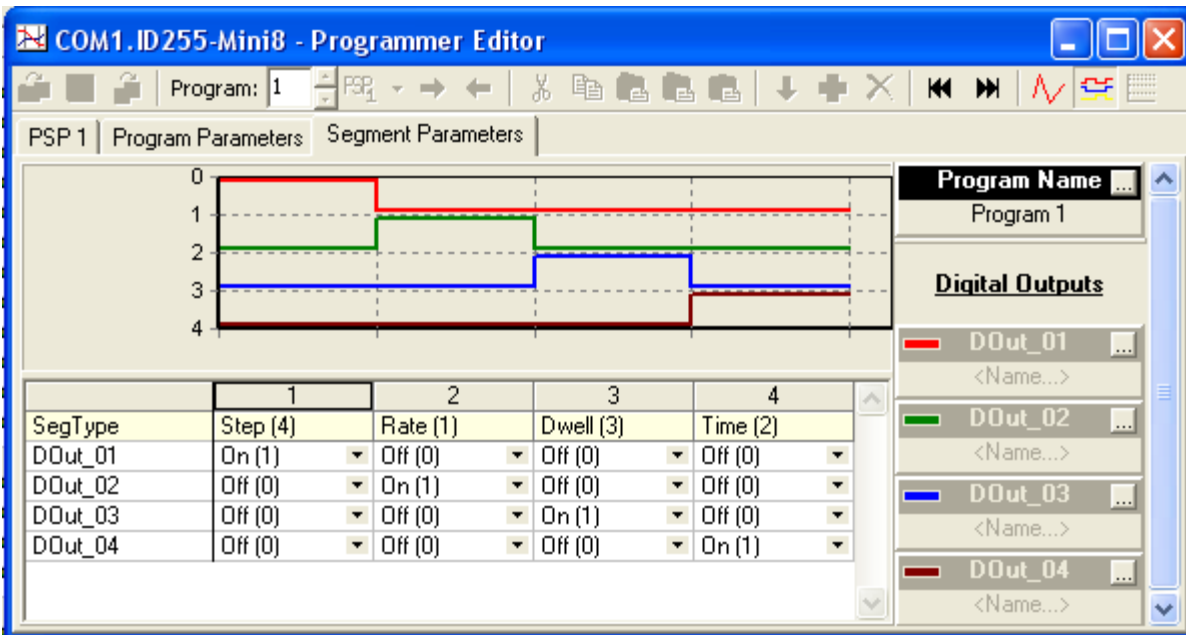

Figure 18-8: Digital Editor showing event outputs

- Once the program is complete it may be saved to file, or loaded to another programmer in this Mini8 controller or in any other Mini8 also connected.



18.14.3 Saving & Loading Programs



If you are online to an instrument the program is already 'loaded'. Use the icon to save it to file. This example would be saved as 'Example.uip' and the programs for ALL the enabled programmer blocks will be saved to this file.

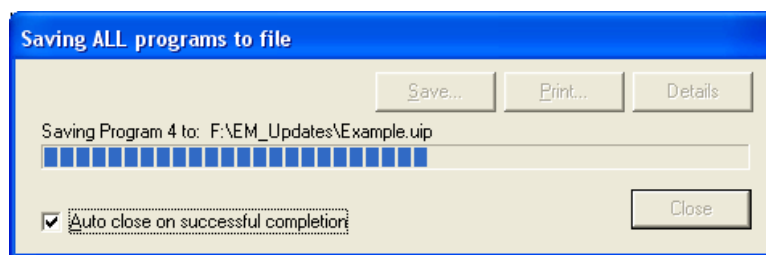

Use  to load a set of programs from disk to ALL the programmer blocks.

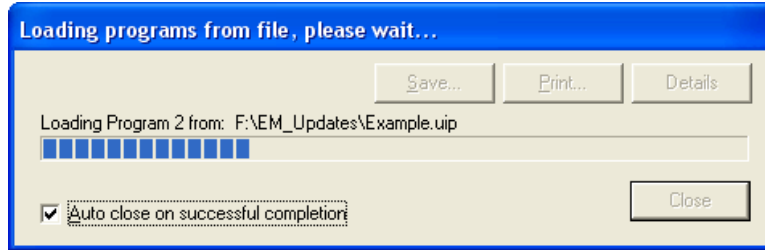

Use  to copy a program from one programmer to another. For this to succeed the source and destination programmer blocks must have the same features enabled - i.e. EventsOut, UserVal etc. Firstly select the instrument on the network, COM1.ID001-Mini8 (or any other Mini8 controller on the network).

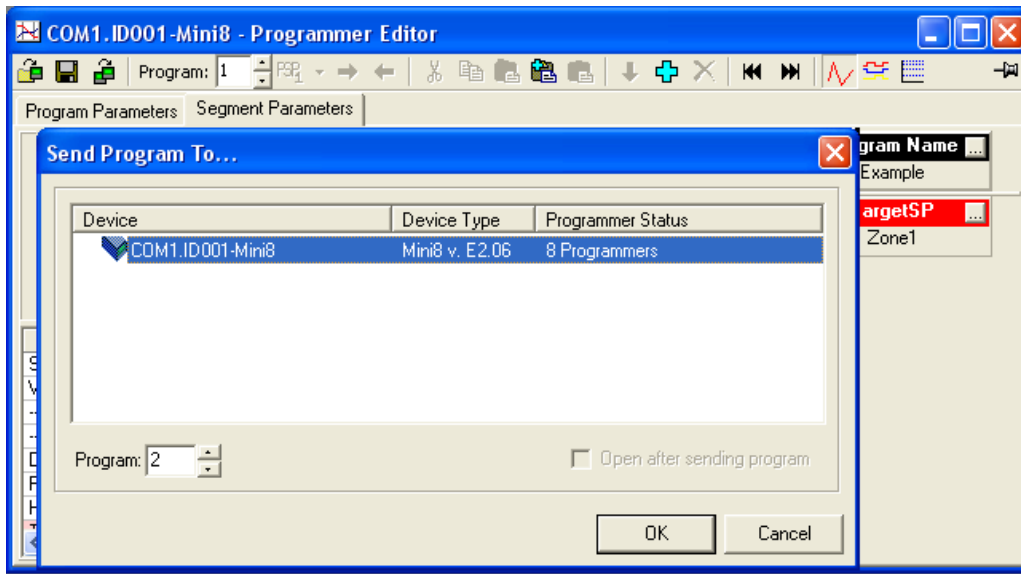

Then set the target programmer number and click OK. In this case the program in Programmer 1 will be sent to Programmer 2. Note it could be sent to a programmer block in any instrument on the network.

18.14.4 Printing a Program

☺ If you select all segments, Cntrl A (or right click 'Select All') and copy spreadsheet cells they are put on the clipboard as tab separated values which can be pasted into Microsoft Excel.

There is no direct printing support in the Programmer Editor, but you can generate a report using Microsoft Excel as follows:

- Right click on the graph and choose 'Copy Chart'.
- Open a new spreadsheet in Excel and paste the chart, position to taste.
- Go back to the Programmer Editor and Choose 'Edit|Select All' followed by 'Edit|Copy'.
- Switch to Excel, choose the top left cell for the segment data and then choose 'Edit|Paste'.
- Optionally delete any columns that have no settings and format the cells.
- Print the spreadsheet.

The program is listed down rather than across the page so long programs can be printed.

18.15 Wiring the Programmer Function Block.

The Programmer block is invariably used with the Loop blocks. When a programmer block is placed on the graphical wiring editor it will **automatically** make the essential connections between itself and its associated Loop block i.e. Programmer 1 with Loop1 etc.

These connections ensure that the program setpoint goes to the loop and that 'servo' and other program options work correctly. Note that for 8 loops & 8 programmers at least 60 wires are required.

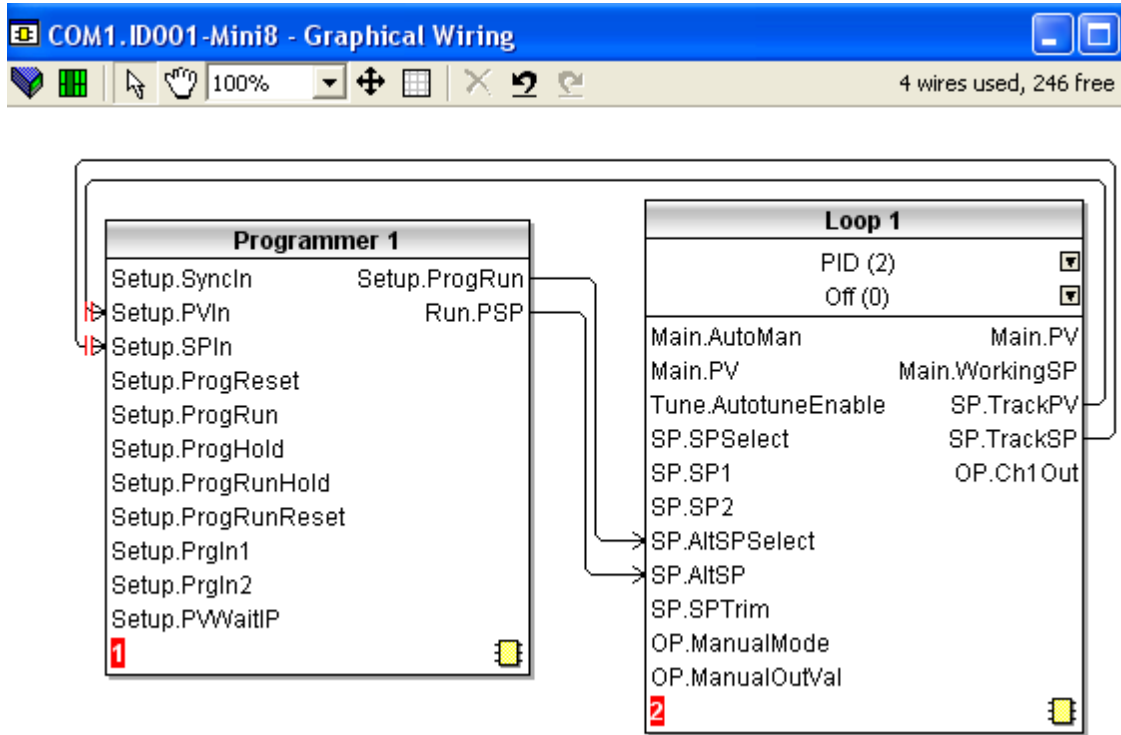

Figure 18-9: Wiring Programmer to Loop Block

When placing a loop block and a programmer block on the graphical wiring editor, if they are the same number (i.e. Loop.1 and Programmer.1), they will automatically wire themselves together as shown. Use this if you require up to 8 loops, each with their own programmer.

In the situation where there are multiple programmer blocks, it is possible to synchronise the programmer blocks by wiring the AND of all the 'Programmer.n.Setup.EndOfSeg' outputs to all the 'Programmer.n.Setup.SyncIn' Inputs.

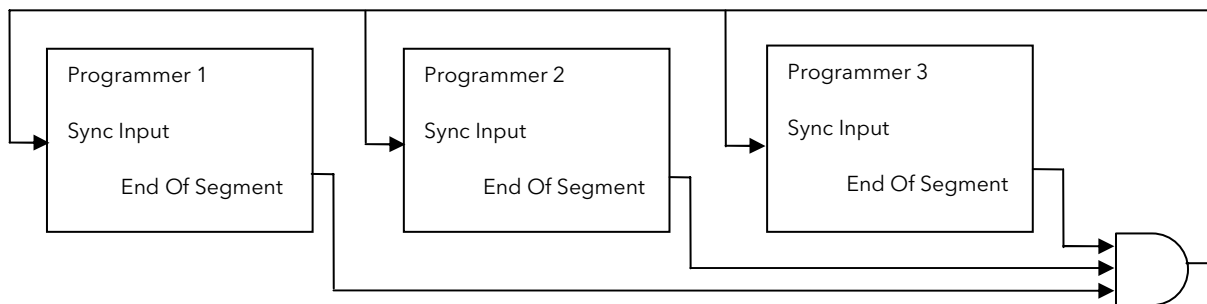

Figure 18-10: Synchronisation of programmer blocks

If a single programmer block is used, wired to several loops then a plan has to be made about the SP & PV feedback to the programmer block. In the design below the AVERAGE PV of the 3 loops has been used for the PV but for the Setpoint Loop1 has been selected as the 'master' and the programmer SP feedback just taken from Loop 1.

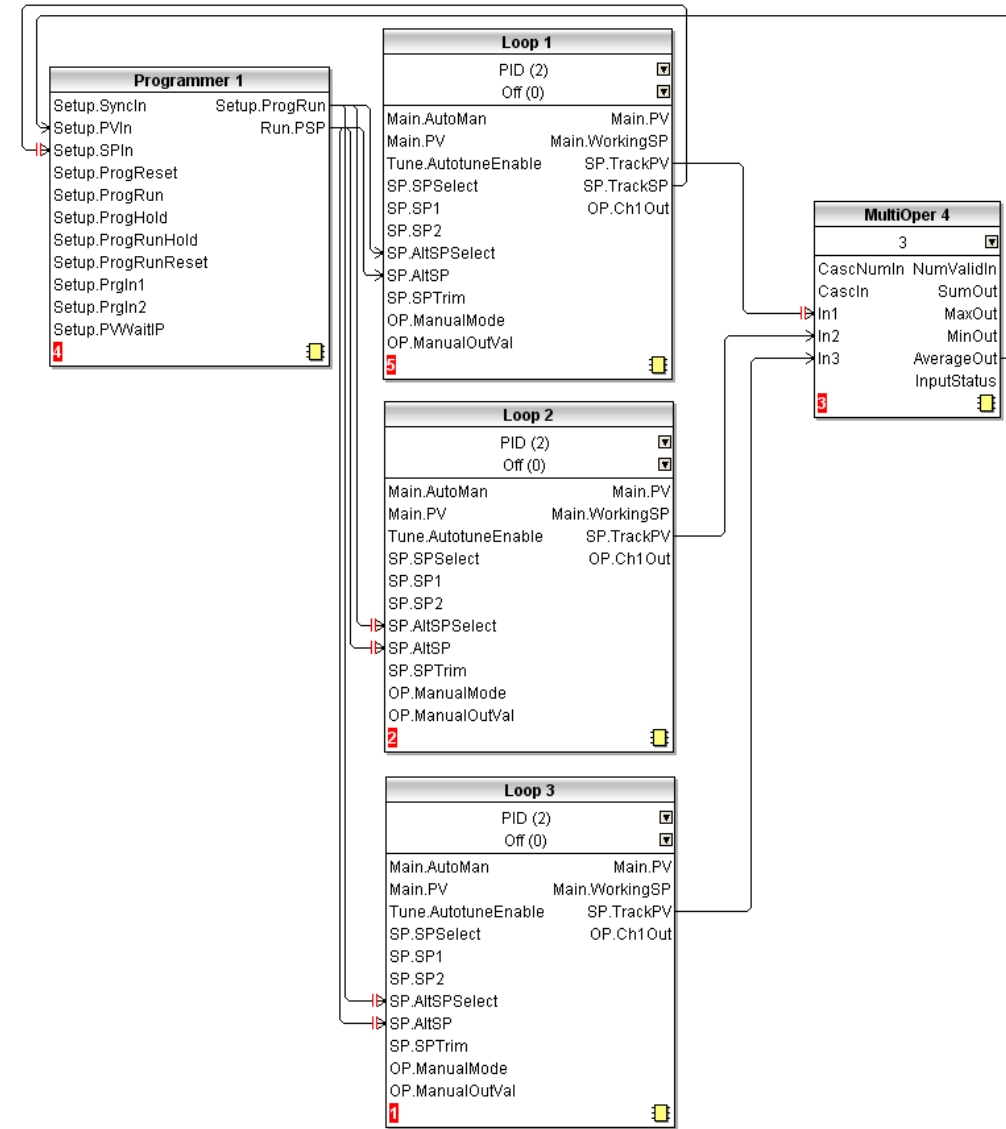

Figure 18-11: Single Programmer with 3 loops.

19. Chapter 19 Switch Over

This facility is commonly used in temperature applications which operate over a wide temperature range. A thermocouple may be used to control at lower temperatures and a pyrometer then controls at very high temperatures. Alternatively two thermocouples of different types may be used.

The diagram below shows a process heating over time with boundaries which define the switching points between the two devices. The higher boundary (2 to 3) is normally set towards the top end of the thermocouple range and this is determined by the 'Switch High' parameter. The lower boundary (1 to 2) is set towards the lower end of the pyrometer (or second thermocouple) range using the parameter 'Switch Low'. The controller calculates a smooth transition between the two devices.

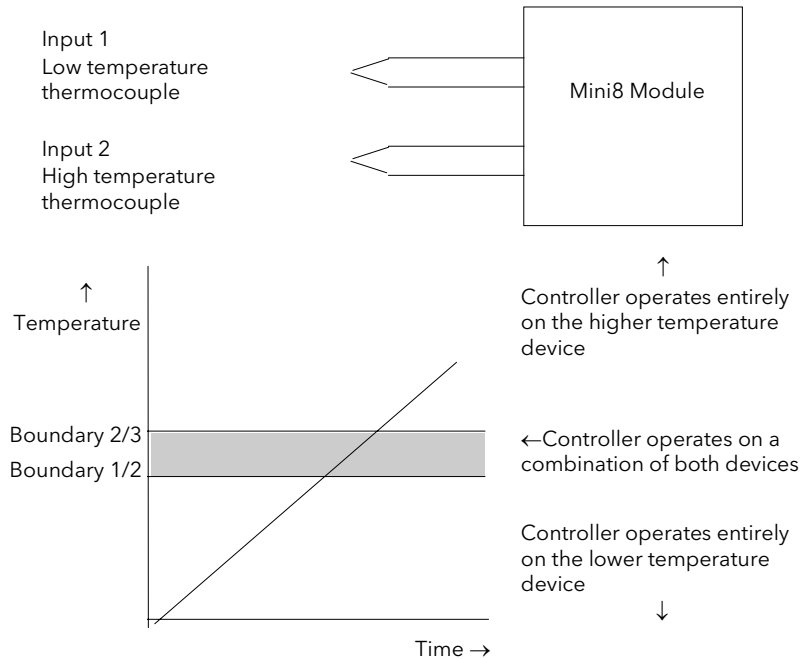

Figure 19-1: Thermocouple to Pyrometer Switching

Example: To Set the Switch Over Levels

Set Access to configuration level

1. Open the 'SwitchOver' Folder
2. Set 'SwitchHigh' to a value which is suitable for the pyrometer (or high temperature thermocouple) to take over the control of the process
3. Set 'SwitchLow' to a value which is suitable for the low temperature thermocouple to control the process

19.1 Switch Over Parameters

Folder - SwitchOver		Sub-folders: .1			
Name	Parameter Description	Value		Default	Access Level
InHigh	Sets the high limit for the switch over block. It is the highest reading from input 2 since it is the high range input sensor.	Input range			Oper
InLow	Sets the low limit for the switch over block. It is the lowest reading from input 1 since it is the low range input sensor				Oper
Switch High	Defines the high boundary of the switchover region	Between Input Hi and Input Lo			Oper
Switch Low	Defines the low boundary of the switchover region.				Oper
In1	The first input value. This must be the low range sensor.	These will normally be wired to the thermocouple/pyrometer input sources via the PV Input or Analogue Input Module. The range will be the range of the input chosen.			R/O if wired
In2	The second input value. This must be the high range sensor				R/O if wired
Fallback Value	In the event of a bad status, the output may be configured to adopt the fallback value. This allows the strategy to dictate a safe output in the event of a fault being detected	Between Input Hi and Input Lo		0.0	Oper
Fallback Type	Fall back type	Clip Bad Clip Good Fall Bad Fall Good Upscale Downscale		Clip Bad	Conf
SelectIn	Indicates which input is currently selected	Input 1	0: Input 1 has been selected 1: Input 2 has been selected		R/O
		Input 2	2: Both inputs are used to calculate the output		
ErrMode	The action taken if the selected input is BAD	UseGood	0: Assumes the value of a good input If the currently selected input is BAD the output will assume the value of the other input if it is GOOD	Use Good	Conf
		ShowBad	1: If selected input is BAD the output is BAD		
Out	Output produced from the 2 input measurements				R/O
Status	Status of the switchover block	Good Bad			R/O

20. Chapter 20 Transducer Scaling

The Mini8 controller includes two transducer calibration function blocks. These are a software function blocks that provide a method of offsetting the calibration of the input when compared to a known input source. Transducer scaling is often performed as a routine operation on a machine to take out system errors. For this reason it can be carried out in operator mode.

Transducer scaling can be applied to any TC8 input set up as a linear PV input. They can be wired to the transducer scaling inputs.

Three types of calibration are explained in this chapter:-

- Auto-tare
- Load Cell Calibration
- Comparison Calibration

20.1 Auto-Tare Calibration

The auto-tare function is used, for example, when it is required to weigh the contents of a container but not the container itself.

The procedure is to place the empty container on the weigh bridge and 'zero' the controller. Since it is likely that following containers may have different tare weights the auto-tare feature is always available.

Further parameters are available which are used to pre-configure the tare measurement or for interrogation purposes. Tare calibration may be carried out no matter what type of transducer is in use.

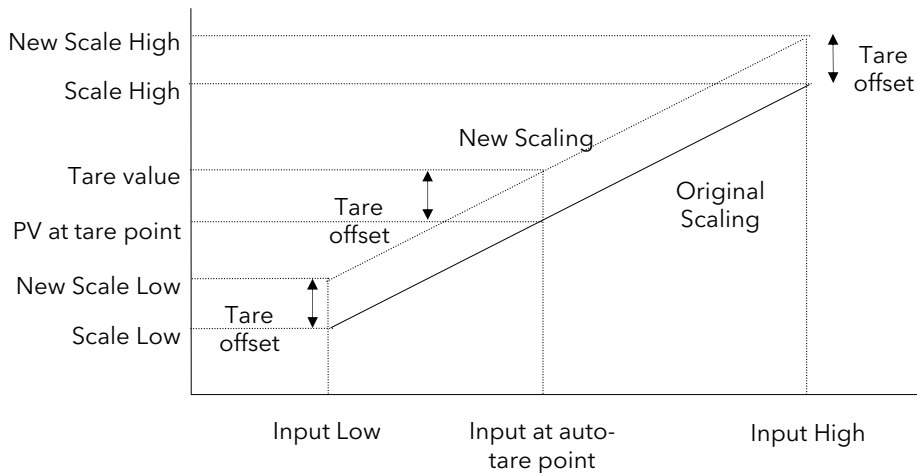

Figure 20-1: Effect of Auto Tare

20.2 Load Cell

A load cell provides a mV analogue output which may be connected to a linear TC8 input.

When no load is placed on the cell the output is normally zero. However, in practice there may be a residual output and this can be calibrated out in the controller.

The high end is calibrated by placing a reference weight on the load cell and performing a high end calibration in the controller.

20.3 Comparison Calibration

Comparison calibration is used to calibrate the controller against a second reference instrument.

The load is removed (or taken to a minimum) from the reference device. The controller low end calibration is done using the 'Cal Enable' parameter and entering the reading from the reference instrument.

Add a weight and when the reading has become stable select the 'Cal Hi Enable' parameter then enter the new reading from the reference instrument.

20.4 Transducer Scaling Parameters

Folder - Txdr		Sub-folders: .1 or .2			
Name	Parameter Description	Value		Default	Access Level
Cal Type	Used to select the type of transducer calibration to perform See descriptions at the beginning of this chapter.	1: Off	Transducer type unconfigured	Off	Conf
		1: Shunt	Shunt calibration		
		2: Load Cell	Load Cell		
		3: Compare	Comparison		
Cal Enable	To make the transducer ready for calibration. Must be set to Yes to allow calibration to be done at L1. This includes Tare Cal.	No Yes	Not ready Ready	No	Conf
Range Max	The maximum permissible range of the scaling block	Range min to 99999		1000	Conf
Range Min	The minimum permissible range of the scaling block	-19999 to Range max		0	Conf
Start Tare	Begin tare calibration	No Yes	Start tare calibration	No	Oper if 'Cal Enable' = 'Yes'
Start Cal	Starts the Calibration process. Note: for Load Cell and Comparison calibration 'Start Cal' starts the first calibration point.	No Yes	Start calibration	No	Oper if 'Cal Enable' = 'Yes'
Start HighCal	For Load Cell and Comparison calibration the 'Start High Cal' must be used to start the second calibration point.	No Yes	Start high calibration	No	Oper if 'Cal Enable' = 'Yes'
Clear Cal	Clears the current calibration constants. This returns the calibration to unity gain	No Yes	To delete previous calibration values	No	Oper
Tare Value	Enter the tare value of the container				Conf
InHigh	Sets the scaling input high point				Oper
InLow	Sets the scaling input low point				Oper
20.4	Sets the scaling output high point. Usually the same as the 'Input Lo'				Oper
Scale Low	Sets the scaling output low point. Usually 80% of 'Input Hi'				Oper

Folder - Txdr		Sub-folders: .1 or .2			
Name	Parameter Description	Value		Default	Access Level
Cal Band	The calibration algorithms use the threshold to determine if the value has settled. When switching in the shunt resistor, the algorithm waits for the value to settle to within the threshold before starting the high calibration point.				Conf
CalAdjust	The adjust is used in the Comparison Calibration method.	When edited, the Adjust parameter can be set to the desired value. On confirm, the new adjust value is used to set the scaling constants			Oper
ShuntOut	Indicates when the internal shunt calibration resistor is switched in. Only appears if 'Cal Type' = 'Shunt'	Off On	Resistor not switched in Resistor switched in		Oper
Cal Active	Indicates calibration taking place	Off On	Inactive Active		R/O
InVal	The input value to be scaled.	-9999.9 to 9999.9			Oper
OutVal	The Input Value is scaled by the block to produce the Output Value				Oper
Status	The status of the output accounting for sensor fail signals passed to the block and the state of the scaling.	Good Bad			Conf
Cal Status	Indicates the progress of calibration	0: Idle 1: Active 2: Passed 3: Failed	No calibration in progress Calibration in progress Calibration Passed Calibration Failed		L1 R/O

20.4.1 Parameter Notes

Enable Cal	<p>This may be wired to a digital input for an external switch. If not wired, then the value may be changed.</p> <p>When enabled the transducer parameters may be altered as described in the previous sections. When the parameter has been turned On it will remain on until turned off manually even if the controller is powered cycled.</p>
Start Tare	<p>This may be wired to a digital input for an external switch. If not wired, then the value may be changed.</p>
Start Cal	<p>This may be wired to a digital input for an external switch. If not wired, then the value may be changed.</p> <p>It starts the calibration procedure for:</p> <ul style="list-style-type: none">Shunt CalibrationThe low point for Load Cell CalibrationThe low point for Comparison Calibration
Start Hi Cal	<p>This may be wired to a digital input for an external switch. If not wired, then the value may be changed.</p> <p>It starts:-</p> <ul style="list-style-type: none">The high point for Load Cell CalibrationThe high point for Comparison Calibration
Clear Cal	<p>This may be wired to a digital input for an external switch. If not wired, then the value may be changed.</p> <p>When enabled the input will reset to default values. A new calibration will overwrite the previous calibration values if Clear Cal is not enabled between calibrations.</p>

20.4.2 Tare Calibration

The Mini8 controller has an auto-tare function that is used, for example, when it is required to weigh the contents of a container but not the container itself.

The procedure is to place the empty container on the weighbridge and 'zero' the controller. The procedure is as follows:-

1. Place container on weighbridge
2. Go to Txdr.1 (or .2) Folder.
3. Transducer calibration Type must be 'Load Cell'.
4. CalEnable must be set to 'Yes'.
5. Set StartTare to 'yes'
6. The controller automatically calibrates the to the tare weight which is measured by the transducer and stores this value.
7. During this measurement Cal Status will show progress. If the cal fails it is probably an 'out of range' problem.

20.4.3 Load Cell

A load cell output must be within the range 0 to 77 mV to go into a TC8 input. Use a shunt for mA inputs, mV can possibly go direct, Volt inputs must use a potential divider.

To calibrate a load cell.

1. Remove all load from the transducer to establish a zero reference.
2. Go to Txdr.1 (or .2) Folder.
3. Transducer calibration Type must be 'Load Cell'.
4. CalEnable must be set to 'Yes'.
5. Set Start Cal to 'yes'
6. The controller will calibrate the low point.
7. Set StartHighCal to 'yes'
8. The controller will calibrate the high point.

Cal Status advises progress and result.

20.4.4 Comparison Calibration

Comparison calibration is used to calibrate the input against a second reference instrument. Typically this might be a local display on the weighing device itself.

To calibrate against a known reference source:-

1. Add a load at the low end of the scale range
2. Go to Txdr.1 (or .2) Folder.
3. Transducer calibration Type must be 'Comparison'.
4. CalEnable must be set to 'Yes'.
5. Enter the reading from the reference instrument into 'Cal Adjust'.
6. Add a load at the high end of the scale.
7. Set StartHighCal to 'yes'
8. The controller will calibrate the high point.

Cal Status advises progress and result.

21. Chapter 21 User Values

User values are registers provided for use in calculations. They may be used as constants in equations or temporary storage in extended calculations. Up to 32 User Values are available. They are arranged in 4 groups of 8. Each User Value can then be set up in the 'UserVal' folder.

21.1 User Value Parameters

Folder - UsrVal		Sub-Folders: .1 to .32		
Name	Parameter Description	Value	Default	Access Level
Units	Units assigned to the User Value	None Abs Temp °C/°F/°K, V, mV, A, mA, PH, mmHg, psi, Bar, mBar, %RH, %, mmWG, inWG, inWW, Ohms, PSIG, %O2, PPM, %CO2, %CP, %/sec, RelTemp °C\°F\°K(rel), Custom 1, Custom 2, Custom 3, Custom 4, Custom 5, Custom 6, sec, min, hrs,		Conf
Resolution	Resolution of the User Value	XXXXX to X.XXXX		Conf
High Limit	The high limit may be set for each user value to prevent the value being set to an out-of-bounds value.			Oper
Low Limit	The low limit of the user value may be set to prevent the user value from being edited to an illegal value. This is important if the user value is to be used as a setpoint.			Oper
Val	To set the value within the range limits	See note 1		Oper
Status	Can be used to force a good or bad status onto a user value. This is useful for testing status inheritance and fallback strategies.	Good Bad	See note 1	Oper

Note 1.

If 'Val' is wired into but 'Status' is not, then, instead of being used to force the Status it will indicate the status of the value as inherited from the wired connection to 'Val'.

22. Chapter 22 Calibration

In this chapter calibration refers to calibration of the inputs of the TC4 / TC8 modules and the RT4 module. Calibration is accessed using the 'Cal State' parameter that is only available in configuration level. Since the controller is calibrated during manufacture to traceable standards for every input range, it is not necessary to calibrate the controller when changing ranges. Furthermore, a continuous automatic check and correction of the calibration during the controllers' normal operation means that it is calibrated for life.

However, it is recognised that, for operational reasons, it may be a requirement to check or re-calibrate the controller. This new calibration is saved as a User Calibration. It is always possible to revert to the factory calibration if necessary.

☺ **Tip:** Consider using the '**Offset**' parameter for User Cal (e.g. Mod.1.Offset). This can be set to correct any measured difference between the Mini8 controller given PV and a calibration value obtained from another source. This is useful where the process setpoint remains at about the same value during use.

Alternatively, if the setpoint range is wide use the two point calibration with the '**LoPoint**', '**LoOffset**', and '**HiPoint**', '**HiOffset**' parameters.

22.1 TC4 / TC8 User calibration

22.1.1 Set Up

No pre-calibration warm-up is required.

As calibration is a single-point on 8 channels, quick enough (a few minutes) to avoid self-heating effects, there are no special environmental, mounting position or ventilation requirements for calibration.

Calibration should be performed at a reasonable ambient temperature (15°C to 35°C). Calibration outside these limits will compromise the expected working accuracy.

Every channel of every TC8 card must be individually connected to the calibrator source using thick copper wire (so the sensor-break voltage drop in the wires and source impedance is minimal).

The voltage source, monitor DVM and the target Mini8 controller should be at the same temperature (to eliminate added series e.m.f. due to thermocouple effects).

The Mini8 controller must be in Configuration Mode.

22.1.2 Zero Calibration

No "zero" calibration point is required for TC4/TC8 input channels

22.1.3 Voltage Calibration

1. Set the Calibrator voltage source to an accurate 50.005mV. (The extra 5uV is to compensate for self-heating tempco effect).
2. Connect the 50mV to channel 1
3. Set Mod.1.CalState to HiCal (23) and then select 'Confirm'
4. When complete set CalState to SaveUser(25)

Exit configuration mode.

22.1.4 CJC Calibration

No CJC calibration required; the sampled values are ratio metric, providing uncalibrated uncertainty of $\pm 1^\circ\text{C}$.

22.1.5 Sensor-Break Limit Check

Apply a 900 Ω resistor to each channel in turn, Sensor Break Type to 'Low', filter to off (0). Verify the SBrkValue is greater than 24.0 and less than 61.0

22.2 To Return to TC4/TC8 Factory Calibration

To clear the User calibration and restore the calibration from the factory.

1. Put Mini8 controller into Configuration Mode
2. Set the 'Mod.1.Calibration State' to LoadFact (24).
3. Return Instrument to Operating Mode.

22.3 RT4 User calibration

22.3.1 Set Up

No pre-calibration warm-up is required.

There are no special environmental, mounting position or ventilation requirements for calibration.

Calibration should be performed at a reasonable ambient temperature (15°C to 35°C). Calibration outside these limits will compromise the expected working accuracy.

Each channel of the RT4 card must be individually connected to the calibrated resistance box using the 4 wire connection.

The Mini8 controller must be in Configuration Mode.

22.3.2 Calibration

1. Wire the resistance box to channel 1 using the four wire connection.
2. Set the Resistance box to **150.0** ohms $\pm 0.02\%$.
3. Set Mod.1.CalState to LoCal (42) and then select 'Confirm'
4. When complete set CalState to SaveUser(45)
5. Set the Resistance box to **400.0** ohms $\pm 0.02\%$.
6. Set Mod.1.CalState to HiCal (43) and then select 'Confirm'
7. When complete set CalState to SaveUser(45)

Exit configuration mode.

22.4 To Return to RT4 Factory Calibration

To clear the User calibration and restore the calibration from the factory.

4. Put Mini8 controller into Configuration Mode
5. Set the 'Mod.1.Calibration State' to LoadFact (44).
6. Return Instrument to Operating Mode.

22.5 Calibration Parameters

List Header - IO		Sub-headers: Mod.1 to Mod.32				
Name	Parameter Description	Value		Default	Access Level	
Cal State	Calibration state of the input	Idle	Normal operation		Idle	Conf
		Hi-50mV	High input calibration for mV ranges			
		Load Fact	Restore factory calibration values			
		Save User	Save the new calibration values			
		Confirm	To start the calibration procedure when one of the above has been selected			
		Go	Starting the automatic calibration procedure			
		Busy	Calibration in progress			
		Passed	Calibration successful			
		Failed	Calibration unsuccessful			
Status	PV Status The current status of the PV.	0	Normal operation			R/O
		1	Initial startup mode			
		2	Input in sensor break			
		3	PV outside operating limits			
		4	Saturated input			
		5	Uncalibrated channel			
		6	No Module			

The above list shows the values of CalState, which appear during a normal calibration procedure. The full list of possible values follows - the number is the enumeration for the parameter.

- | | |
|---|--|
| 1: Idle | 35: User calibration stored |
| 2: Low calibration point for Volts range | 36: Factory calibration stored |
| 3: High calibration point for Volts range | 41: Idle |
| 4: Calibration restored to factory default values | 42: Low calibration point for RTD calibration (150 ohms) |
| 5: User calibration stored | 43: Low calibration point for RTD calibration (400 ohms) |
| 6: Factory calibration stored | 44: Calibration restored to factory default values |
| 11: Idle | 45: User calibration stored |
| 12: Low calibration point for HZ input | 46: Factory calibration stored |
| 13: High calibration point for the HZ input | 51: Idle |
| 14: Calibration restored to factory default values | 52: CJC calibration used in conjunction with Term Temp parameter |
| 15: User calibration stored | 54: Calibration restored to factory default values |
| 16: Factory calibration stored | 55: User calibration stored |
| 20: Calibration point for factory rough calibration | 56: Factory calibration stored |
| 21: Idle | 200: Confirmation of request to calibrate |
| 22: Low calibration point for the mV range | 201: Used to start the calibration procedure |
| 23: Hi calibration point for the mV range | 202: Used to abort the calibration procedure |
| 24: Calibration restored to factory default values | 210: Calibration point for factory rough calibration |
| 25: User calibration stored | 212: Indication that calibration is in progress |
| 26: Factory calibration stored | 213: Used to abort the calibration procedure |
| 30: Calibration point for factory rough calibration | 220: Indication that calibration completed successfully |
| 31: Idle | 221: Calibration accepted but not stored |
| 32: Low calibration point for the mV range | 222: Used to abort the calibration procedure |
| 33: High calibration point for the mV range | 223: Indication that calibration failed |
| 34: Calibration restored to factory default values | |

23. Chapter 23 OEM Security

23.1 Introduction

OEM security allows users, typically OEMs or distributors, to be able to protect their intellectual property by preventing unauthorised cloning of controller configurations.

OEM security is only available as a special order and is identified by special number EU0725 which appears on the label showing the order code.

The feature provides the user with the ability to enter an ***OEM Security Password***, after which, unless the password is entered, it inhibits iTools from communicating with the controller in its normal way.

Notes:

1. It will still be possible to access communication parameters via the SCADA table.
2. If features such as OPC Scope are required then Custom Tags may be used to access the SCADA area.

23.2 Using OEM Security

The OEM Security feature enables three new addresses to become active in the SCADA region. These are:-

1. Address 16116, 'Locked': this is a read only Boolean parameter that returns 1 (TRUE) when the instrument is OEM secured.
2. Address 16117, 'Lock Code': this is a write only parameter which will read back as 0. When the instrument is unlocked, a value entered here will lock the instrument and defines the code needed to unlock. The code and locked status will be saved in non-volatile memory.
3. Address 16118, 'Unlock Code': this is a write only parameter which will read back as 0. When the instrument is locked, a value entered here will be compared with the lock code. If it is the same, the instrument will be unlocked. If the value is different, this parameter will become unavailable for a time period. This time will increase for each failed attempt.

These addresses are not available by default in iTools. It is, therefore, necessary to create Custom Tags in iTools to be able to write or read these parameters. The following procedure shows how to do this and how to use the OEM security features.

23.3 Step 1 - View iTools OPC Server

With iTools open and connected to the target instrument open the iTools OPC server using Options>Advanced>Show Server.

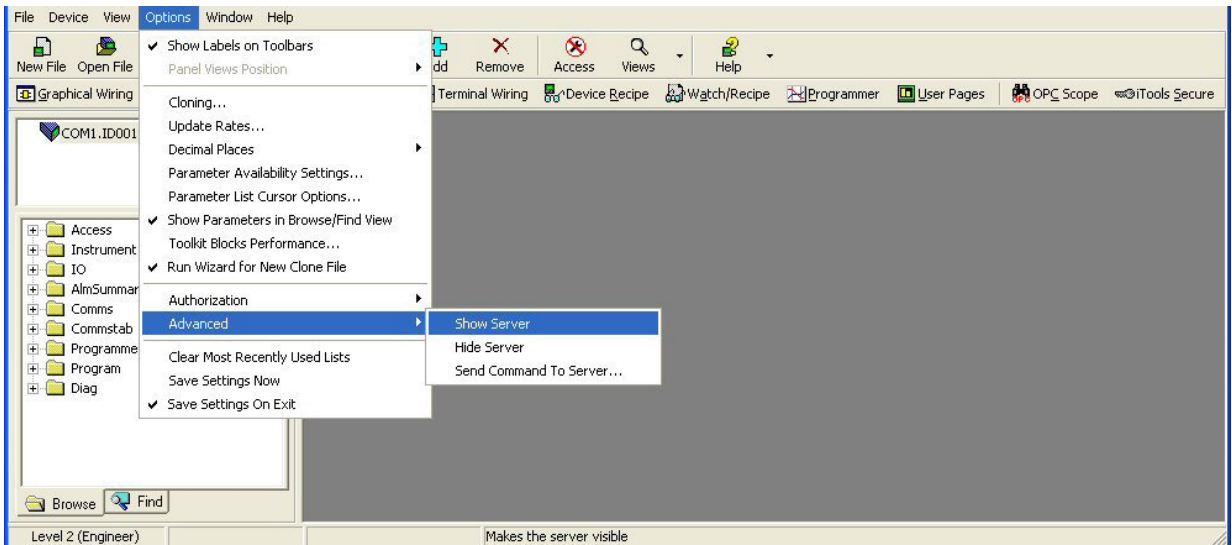

Click on the OPC Server application on your windows Taskbar to view the server.

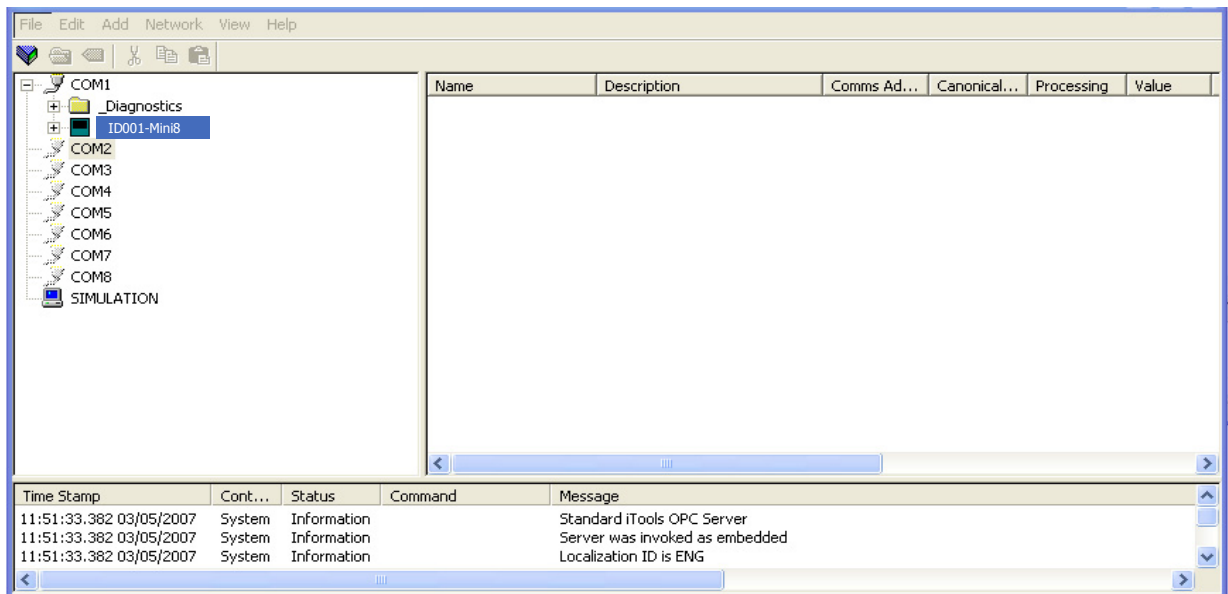

23.4 Step 2 - Create Custom Tags

Expand the connected instrument to show all folders. Close to the bottom of the tree you will find a folder called CustTags.

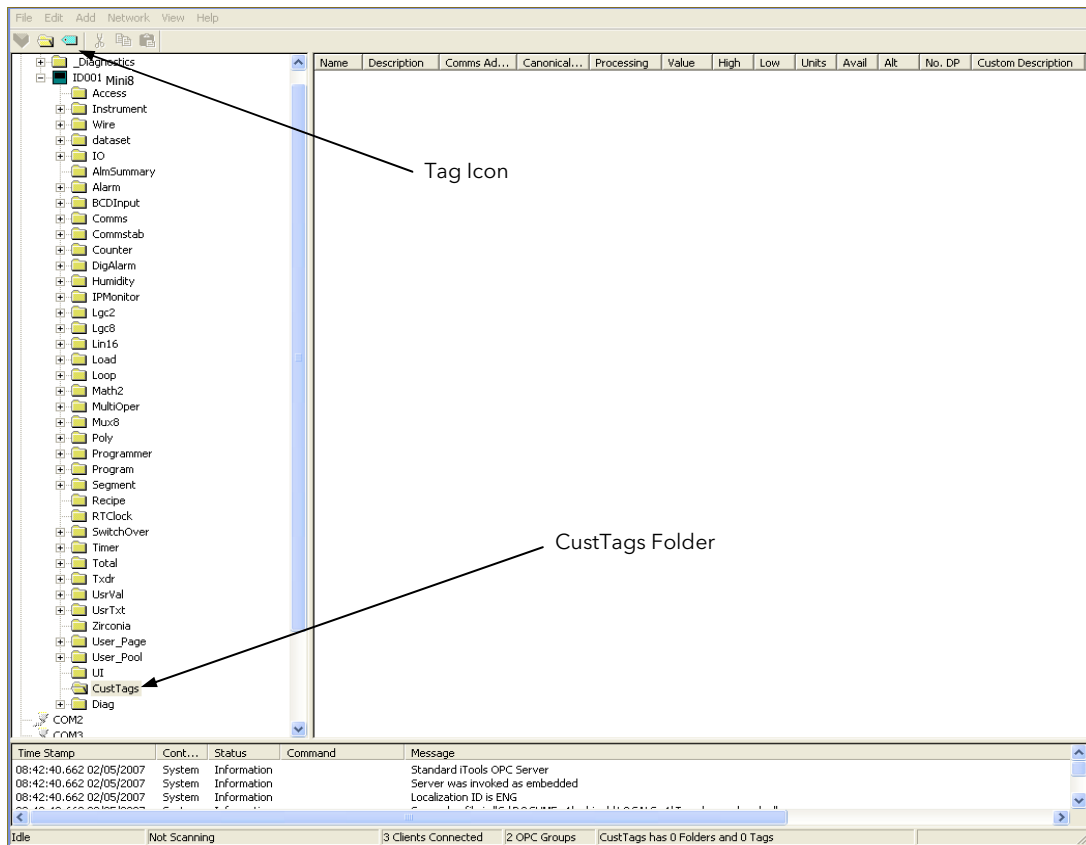

Click on CustTags then click on the Tag icon on the Toolbar. Enter the name of the Tag as 'Locked' and its address as 16116 then press OK. Repeat for the 'Lock' and 'Unlock Code' addresses

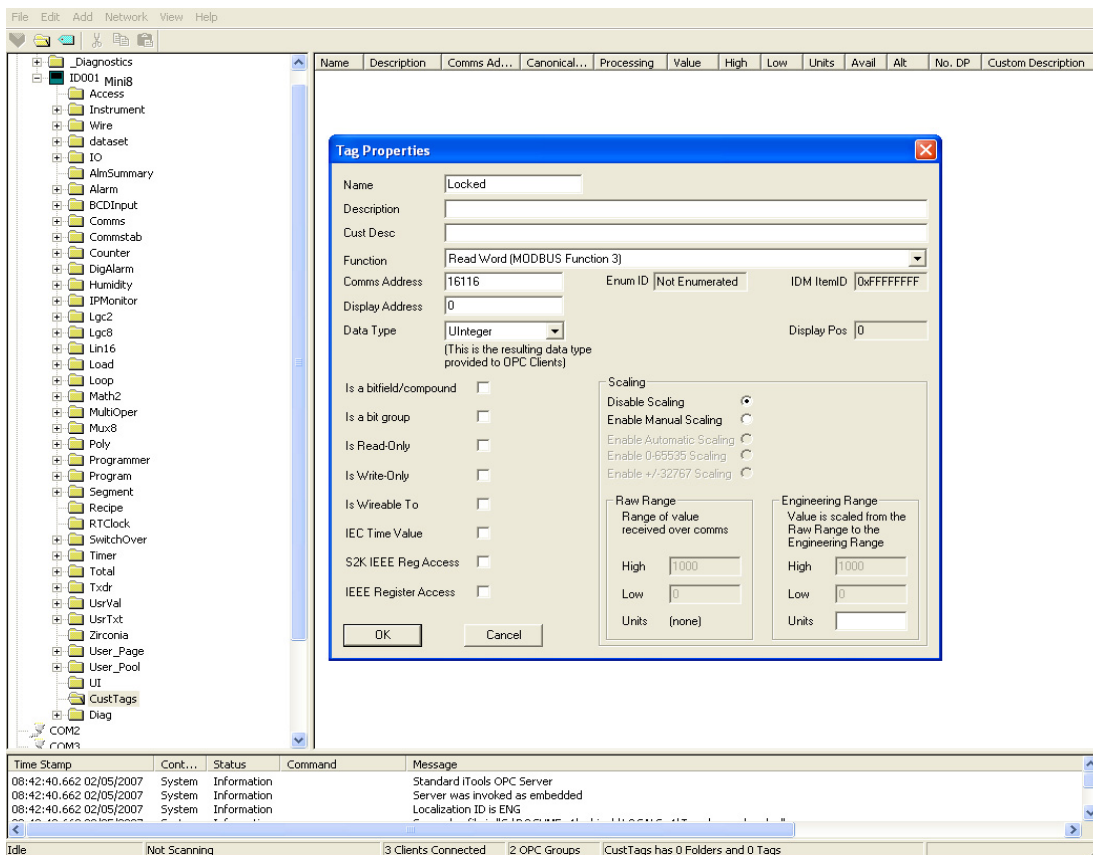

When all three Tags are created you will see the following:-

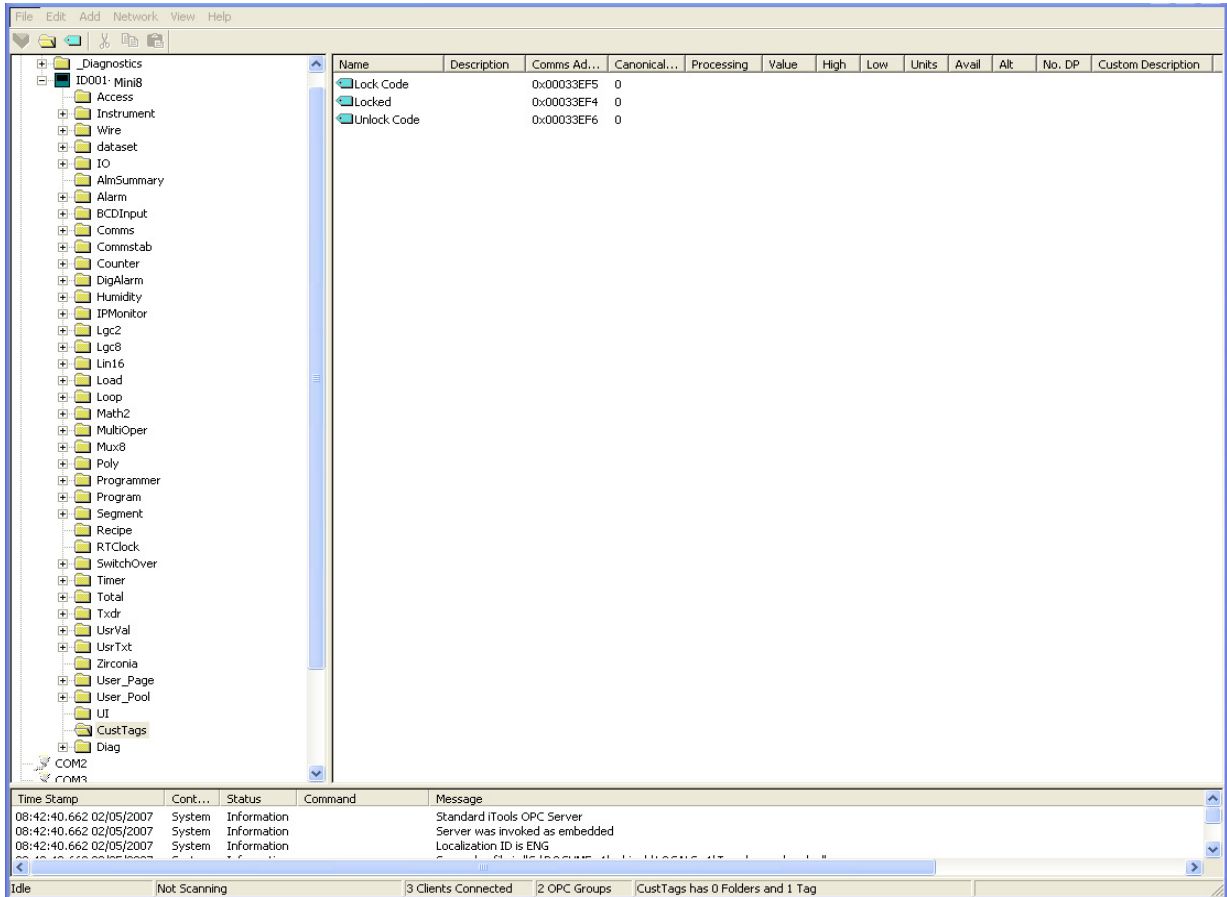

Minimise (do not close) the OPC server to the taskbar and return to iTools. You can now select CustTags on the connected instrument by double clicking on the folder when in the browse tab.

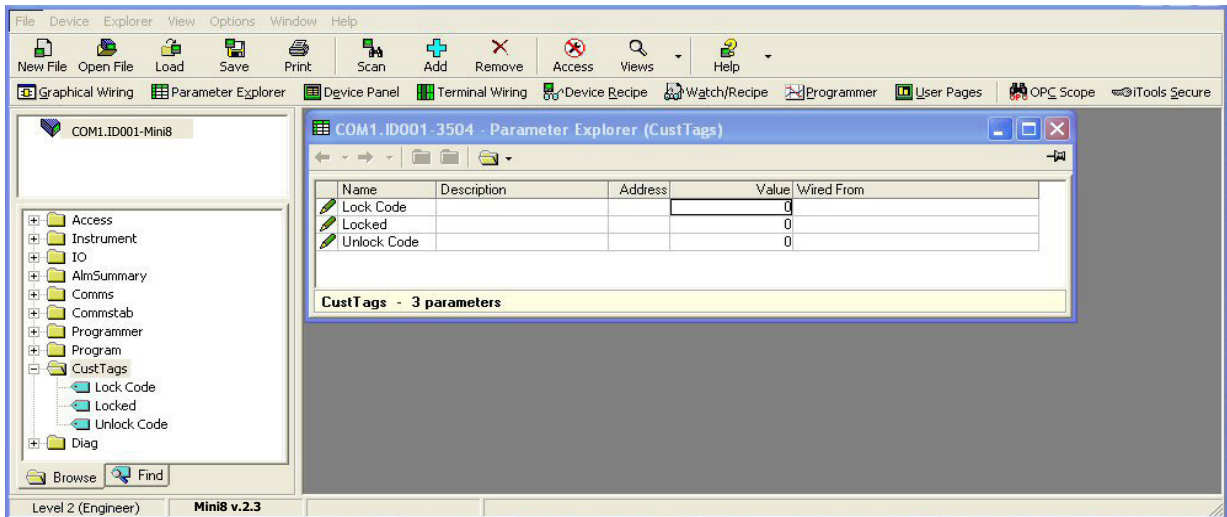

23.5 Step 3 - Activate OEM Security

At the same time as viewing the CustTag parameters double click on another folder and position it show that you can see parameters from both.

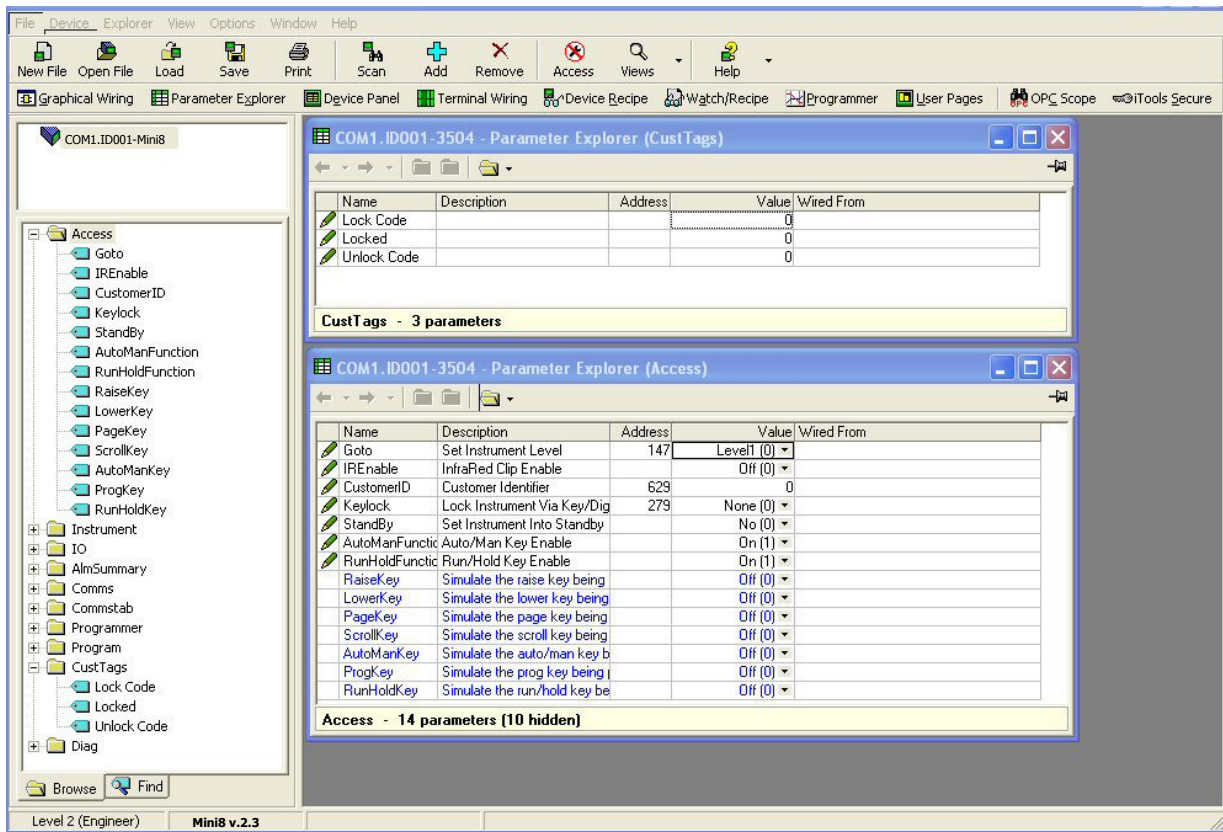

Enter a numerical code for the parameter 'Lock Code' and notice that the 'Locked' parameter now shows true(1) and the parameters in the other folder now show question marks indicating that iTools is no longer reading them.

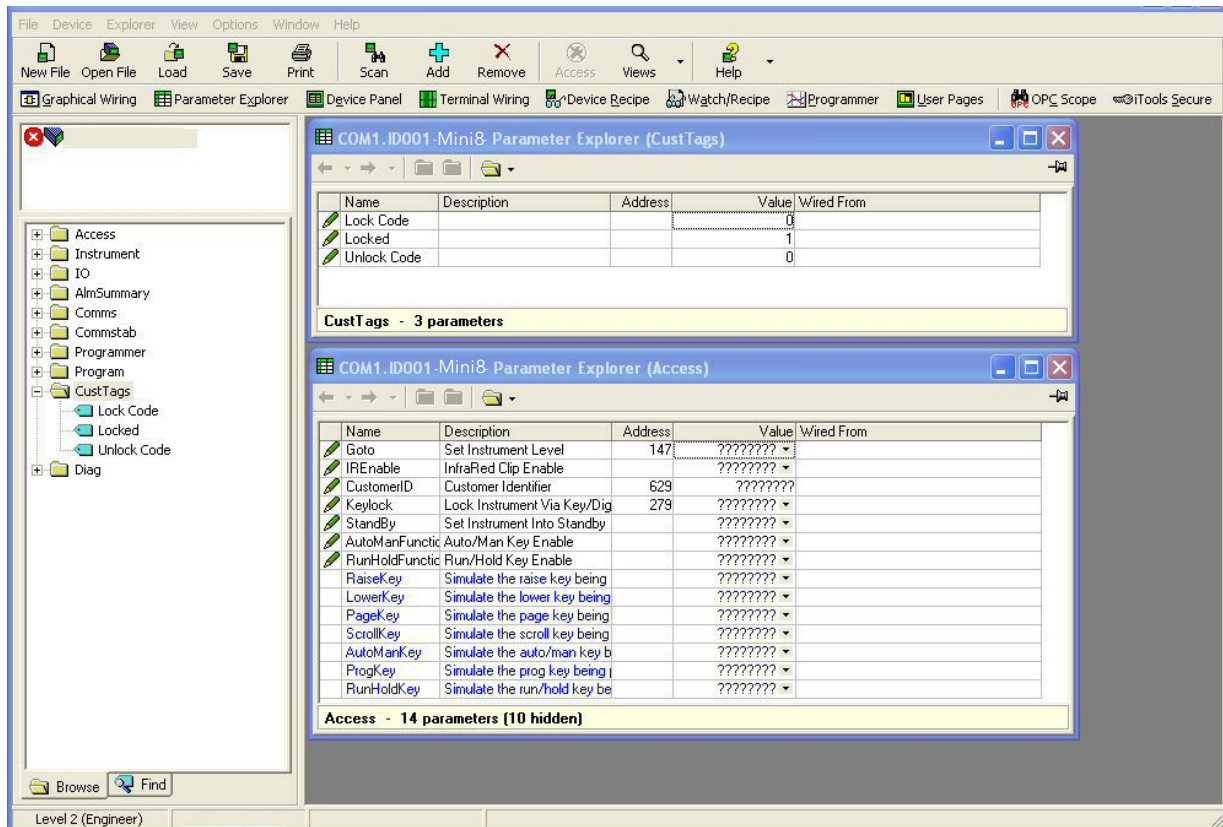

23.6 Step 4 - Deactivate OEM Security

Enter the code you used in step 3 into 'Unlock Code' to enable full iTools communication.

If an incorrect code is entered this parameter will become unavailable for a time period, indicated by a warning message 'Failed to write data to device'. This time will increase for each failed attempt limited to 1 minute. If the correct code is entered while the time delay is in operation it will not be accepted. It will be necessary to wait until the time delay is no longer operative (up to 1 minute) or to power cycle the controller.

23.7 Erasing Memory

Since the OEM Lock/Unlock code is retained in 'normal' non-volatile memory, it may be erased by use of the Access.ClearMemory (Cold Start) parameter. Using this parameter to erase AllMemory will not only unlock the OEM Security but it will also erase the application being protected.

Note that the instrument must be in Config mode to accept the ClearMemory command. This process may also be done via the SCADA area. The Instrument Mode parameter is already in the SCADA area at address 199 - write a value of 2 to set Config mode. The Clear Memory parameter will be found at address 16119. Set a value of 5 (AllMemory) to clear the memory.

24. Appendix A MODBUS SCADA TABLE

These parameters are single register Modbus values for use with Third Party Modbus masters in SCADA packages or plcs. Scaling of the parameters has to be configured - the Modbus master scaling has to match the Mini8 controller parameter resolution to ensure the decimal point is in the correct position.

If a parameter has no address the CommsTab feature can be used to map the parameter to a modbus address, however, it should be noted that the address field will not be updated.

24.1 Comms Table

The tables that follow do not include every parameter in the Mini8 controller. The Comms Table is used to make most parameters available at any SCADA address.

Folder - Commstab		Sub-folders: .1 to .250		
Name	Parameter Description	Value	Default	Access Level
Destination	Modbus Destination	Not Used 0 to 16064	Not used	Conf
Source	Source Parameter	Taken from source parameter		Conf
Native	Native Data Format	0 Integer 1 Native (i.e. Float or long)	Integer	Conf
ReadOnly	Read Only Read/Write only if source is R/W	0 Read/Write 1 Read Only	R/W	Conf
Minutes	Minutes Units in which time is scaled.	0 Seconds 1 Minutes	Seconds	Conf

Entering a value in the Source parameter may be done in two ways:

- 1 - drag the required parameter into the Source
- 2 - right click the Source parameter, select Edit Wire and browse to the required parameter.

In the Example below the PV of Loop 1 would be available at addresses 200 and 201 as a two register floating point number - its native data type.

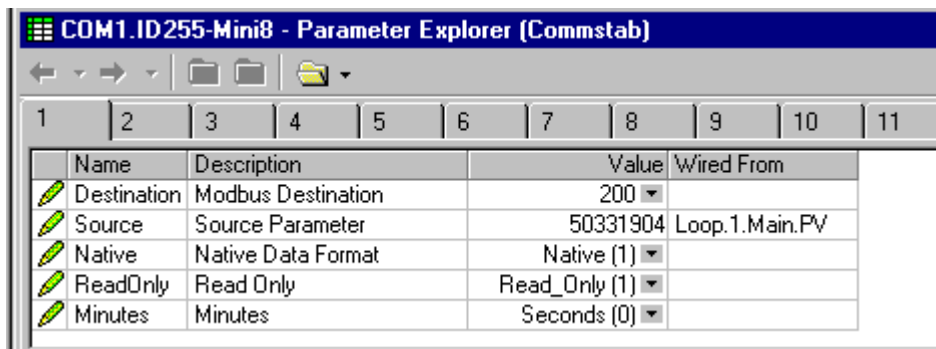

There are 250 comms table entries available.

24.2 SCADA Table

The parameters in the tables following are available in scaled integer format, accessed via their associated Modbus address.

Wherever possible use an OPC client with the iTools OPCserver as the server. In this arrangement the parameters are all referenced by name and the values are floating point so the decimal point for all parameters is inherited.

MINI8 CONTROLLER: ENGINEERING HANDBOOK

Parameter Description / Modbus address	DEC	HEX	Parameter Description / Modbus address	DEC	HEX
Access.CustomerID	4739	0x1283	Alarm.6.Inhibit	10327	0x2857
Access.InstrumentMode	199	0x00c7	Alarm.6.Latch	10324	0x2854
Alarm.1.Ack	10250	0x280a	Alarm.6.Out	10329	0x2859
Alarm.1.Block	10246	0x2806	Alarm.6.Reference	10323	0x2853
Alarm.1.Delay	10248	0x2808	Alarm.6.Threshold	10321	0x2851
Alarm.1.Hysteresis	10242	0x2802	Alarm.6.Type	10320	0x2850
Alarm.1.Inhibit	10247	0x2807	Alarm.7.Ack	10346	0x286a
Alarm.1.Latch	10244	0x2804	Alarm.7.Block	10342	0x2866
Alarm.1.Out	10249	0x2809	Alarm.7.Delay	10344	0x2868
Alarm.1.Reference	10243	0x2803	Alarm.7.Hysteresis	10338	0x2862
Alarm.1.Threshold	10241	0x2801	Alarm.7.Inhibit	10343	0x2867
Alarm.1.Type	10240	0x2800	Alarm.7.Latch	10340	0x2864
Alarm.2.Ack	10266	0x281a	Alarm.7.Out	10345	0x2869
Alarm.2.Block	10262	0x2816	Alarm.7.Reference	10339	0x2863
Alarm.2.Delay	10264	0x2818	Alarm.7.Threshold	10337	0x2861
Alarm.2.Hysteresis	10258	0x2812	Alarm.7.Type	10336	0x2860
Alarm.2.Inhibit	10263	0x2817	Alarm.8.Ack	10362	0x287a
Alarm.2.Latch	10260	0x2814	Alarm.8.Block	10358	0x2876
Alarm.2.Out	10265	0x2819	Alarm.8.Delay	10360	0x2878
Alarm.2.Reference	10259	0x2813	Alarm.8.Hysteresis	10354	0x2872
Alarm.2.Threshold	10257	0x2811	Alarm.8.Inhibit	10359	0x2877
Alarm.2.Type	10256	0x2810	Alarm.8.Latch	10356	0x2874
Alarm.3.Ack	10282	0x282a	Alarm.8.Out	10361	0x2879
Alarm.3.Block	10278	0x2826	Alarm.8.Reference	10355	0x2873
Alarm.3.Delay	10280	0x2828	Alarm.8.Threshold	10353	0x2871
Alarm.3.Hysteresis	10274	0x2822	Alarm.8.Type	10352	0x2870
Alarm.3.Inhibit	10279	0x2827	Alarm.9.Ack	10378	0x288a
Alarm.3.Latch	10276	0x2824	Alarm.9.Block	10374	0x2886
Alarm.3.Out	10281	0x2829	Alarm.9.Delay	10376	0x2888
Alarm.3.Reference	10275	0x2823	Alarm.9.Hysteresis	10370	0x2882
Alarm.3.Threshold	10273	0x2821	Alarm.9.Inhibit	10375	0x2887
Alarm.3.Type	10272	0x2820	Alarm.9.Latch	10372	0x2884
Alarm.4.Ack	10298	0x283a	Alarm.9.Out	10377	0x2889
Alarm.4.Block	10294	0x2836	Alarm.9.Reference	10371	0x2883
Alarm.4.Delay	10296	0x2838	Alarm.9.Threshold	10369	0x2881
Alarm.4.Hysteresis	10290	0x2832	Alarm.9.Type	10368	0x2880
Alarm.4.Inhibit	10295	0x2837	Alarm.10.Ack	10394	0x289a
Alarm.4.Latch	10292	0x2834	Alarm.10.Block	10390	0x2896
Alarm.4.Out	10297	0x2839	Alarm.10.Delay	10392	0x2898
Alarm.4.Reference	10291	0x2833	Alarm.10.Hysteresis	10386	0x2892
Alarm.4.Threshold	10289	0x2831	Alarm.10.Inhibit	10391	0x2897
Alarm.4.Type	10288	0x2830	Alarm.10.Latch	10388	0x2894
Alarm.5.Ack	10314	0x284a	Alarm.10.Out	10393	0x2899
Alarm.5.Block	10310	0x2846	Alarm.10.Reference	10387	0x2893
Alarm.5.Delay	10312	0x2848	Alarm.10.Threshold	10385	0x2891
Alarm.5.Hysteresis	10306	0x2842	Alarm.10.Type	10384	0x2890
Alarm.5.Inhibit	10311	0x2847	Alarm.11.Ack	10410	0x28aa
Alarm.5.Latch	10308	0x2844	Alarm.11.Block	10406	0x28a6
Alarm.5.Out	10313	0x2849	Alarm.11.Delay	10408	0x28a8
Alarm.5.Reference	10307	0x2843	Alarm.11.Hysteresis	10402	0x28a2
Alarm.5.Threshold	10305	0x2841	Alarm.11.Inhibit	10407	0x28a7
Alarm.5.Type	10304	0x2840	Alarm.11.Latch	10404	0x28a4
Alarm.6.Ack	10330	0x285a	Alarm.11.Out	10409	0x28a9
Alarm.6.Block	10326	0x2856	Alarm.11.Reference	10403	0x28a3
Alarm.6.Delay	10328	0x2858	Alarm.11.Threshold	10401	0x28a1
Alarm.6.Hysteresis	10322	0x2852	Alarm.11.Type	10400	0x28a0

MINI8 CONTROLLER: ENGINEERING HANDBOOK

Parameter Description / Modbus address	DEC	HEX	Parameter Description / Modbus address	DEC	HEX
Alarm.12.Ack	10426	0x28ba	Alarm.17.Latch	10500	0x2904
Alarm.12.Block	10422	0x28b6	Alarm.17.Out	10505	0x2909
Alarm.12.Delay	10424	0x28b8	Alarm.17.Reference	10499	0x2903
Alarm.12.Hysteresis	10418	0x28b2	Alarm.17.Threshold	10497	0x2901
Alarm.12.Inhibit	10423	0x28b7	Alarm.17.Type	10496	0x2900
Alarm.12.Latch	10420	0x28b4	Alarm.18.Ack	10522	0x291a
Alarm.12.Out	10425	0x28b9	Alarm.18.Block	10518	0x2916
Alarm.12.Reference	10419	0x28b3	Alarm.18.Delay	10520	0x2918
Alarm.12.Threshold	10417	0x28b1	Alarm.18.Hysteresis	10514	0x2912
Alarm.12.Type	10416	0x28b0	Alarm.18.Inhibit	10519	0x2917
Alarm.13.Ack	10442	0x28ca	Alarm.18.Latch	10516	0x2914
Alarm.13.Block	10438	0x28c6	Alarm.18.Out	10521	0x2919
Alarm.13.Delay	10440	0x28c8	Alarm.18.Reference	10515	0x2913
Alarm.13.Hysteresis	10434	0x28c2	Alarm.18.Threshold	10513	0x2911
Alarm.13.Inhibit	10439	0x28c7	Alarm.18.Type	10512	0x2910
Alarm.13.Latch	10436	0x28c4	Alarm.19.Ack	10538	0x292a
Alarm.13.Out	10441	0x28c9	Alarm.19.Block	10534	0x2926
Alarm.13.Reference	10435	0x28c3	Alarm.19.Delay	10536	0x2928
Alarm.13.Threshold	10433	0x28c1	Alarm.19.Hysteresis	10530	0x2922
Alarm.13.Type	10432	0x28c0	Alarm.19.Inhibit	10535	0x2927
Alarm.14.Ack	10458	0x28da	Alarm.19.Latch	10532	0x2924
Alarm.14.Block	10454	0x28d6	Alarm.19.Out	10537	0x2929
Alarm.14.Delay	10456	0x28d8	Alarm.19.Reference	10531	0x2923
Alarm.14.Hysteresis	10450	0x28d2	Alarm.19.Threshold	10529	0x2921
Alarm.14.Inhibit	10455	0x28d7	Alarm.19.Type	10528	0x2920
Alarm.14.Latch	10452	0x28d4	Alarm.20.Ack	10554	0x293a
Alarm.14.Out	10457	0x28d9	Alarm.20.Block	10550	0x2936
Alarm.14.Reference	10451	0x28d3	Alarm.20.Delay	10552	0x2938
Alarm.14.Threshold	10449	0x28d1	Alarm.20.Hysteresis	10546	0x2932
Alarm.14.Type	10448	0x28d0	Alarm.20.Inhibit	10551	0x2937
Alarm.15.Ack	10474	0x28ea	Alarm.20.Latch	10548	0x2934
Alarm.15.Block	10470	0x28e6	Alarm.20.Out	10553	0x2939
Alarm.15.Delay	10472	0x28e8	Alarm.20.Reference	10547	0x2933
Alarm.15.Hysteresis	10466	0x28e2	Alarm.20.Threshold	10545	0x2931
Alarm.15.Inhibit	10471	0x28e7	Alarm.20.Type	10544	0x2930
Alarm.15.Latch	10468	0x28e4	Alarm.21.Ack	10570	0x294a
Alarm.15.Out	10473	0x28e9	Alarm.21.Block	10566	0x2946
Alarm.15.Reference	10467	0x28e3	Alarm.21.Delay	10568	0x2948
Alarm.15.Threshold	10465	0x28e1	Alarm.21.Hysteresis	10562	0x2942
Alarm.15.Type	10464	0x28e0	Alarm.21.Inhibit	10567	0x2947
Alarm.16.Ack	10490	0x28fa	Alarm.21.Latch	10564	0x2944
Alarm.16.Block	10486	0x28f6	Alarm.21.Out	10569	0x2949
Alarm.16.Delay	10488	0x28f8	Alarm.21.Reference	10563	0x2943
Alarm.16.Hysteresis	10482	0x28f2	Alarm.21.Threshold	10561	0x2941
Alarm.16.Inhibit	10487	0x28f7	Alarm.21.Type	10560	0x2940
Alarm.16.Latch	10484	0x28f4	Alarm.22.Ack	10586	0x295a
Alarm.16.Out	10489	0x28f9	Alarm.22.Block	10582	0x2956
Alarm.16.Reference	10483	0x28f3	Alarm.22.Delay	10584	0x2958
Alarm.16.Threshold	10481	0x28f1	Alarm.22.Hysteresis	10578	0x2952
Alarm.16.Type	10480	0x28f0	Alarm.22.Inhibit	10583	0x2957
Alarm.17.Ack	10506	0x290a	Alarm.22.Latch	10580	0x2954
Alarm.17.Block	10502	0x2906	Alarm.22.Out	10585	0x2959
Alarm.17.Delay	10504	0x2908	Alarm.22.Reference	10579	0x2953
Alarm.17.Hysteresis	10498	0x2902	Alarm.22.Threshold	10577	0x2951
Alarm.17.Inhibit	10503	0x2907	Alarm.22.Type	10576	0x2950

MINI8 CONTROLLER: ENGINEERING HANDBOOK

Parameter Description / Modbus address	DEC	HEX	Parameter Description / Modbus address	DEC	HEX
Alarm.23.Ack	10602	0x296a	Alarm.28.Out	10681	0x29b9
Alarm.23.Block	10598	0x2966	Alarm.28.Reference	10675	0x29b3
Alarm.23.Delay	10600	0x2968	Alarm.28.Threshold	10673	0x29b1
Alarm.23.Hysteresis	10594	0x2962	Alarm.28.Type	10672	0x29b0
Alarm.23.Inhibit	10599	0x2967	Alarm.29.Ack	10698	0x29ca
Alarm.23.Latch	10596	0x2964	Alarm.29.Block	10694	0x29c6
Alarm.23.Out	10601	0x2969	Alarm.29.Delay	10696	0x29c8
Alarm.23.Reference	10595	0x2963	Alarm.29.Hysteresis	10690	0x29c2
Alarm.23.Threshold	10593	0x2961	Alarm.29.Inhibit	10695	0x29c7
Alarm.23.Type	10592	0x2960	Alarm.29.Latch	10692	0x29c4
Alarm.24.Ack	10618	0x297a	Alarm.29.Out	10697	0x29c9
Alarm.24.Block	10614	0x2976	Alarm.29.Reference	10691	0x29c3
Alarm.24.Delay	10616	0x2978	Alarm.29.Threshold	10689	0x29c1
Alarm.24.Hysteresis	10610	0x2972	Alarm.29.Type	10688	0x29c0
Alarm.24.Inhibit	10615	0x2977	Alarm.30.Ack	10714	0x29da
Alarm.24.Latch	10612	0x2974	Alarm.30.Block	10710	0x29d6
Alarm.24.Out	10617	0x2979	Alarm.30.Delay	10712	0x29d8
Alarm.24.Reference	10611	0x2973	Alarm.30.Hysteresis	10706	0x29d2
Alarm.24.Threshold	10609	0x2971	Alarm.30.Inhibit	10711	0x29d7
Alarm.24.Type	10608	0x2970	Alarm.30.Latch	10708	0x29d4
Alarm.25.Ack	10634	0x298a	Alarm.30.Out	10713	0x29d9
Alarm.25.Block	10630	0x2986	Alarm.30.Reference	10707	0x29d3
Alarm.25.Delay	10632	0x2988	Alarm.30.Threshold	10705	0x29d1
Alarm.25.Hysteresis	10626	0x2982	Alarm.30.Type	10704	0x29d0
Alarm.25.Inhibit	10631	0x2987	Alarm.31.Ack	10730	0x29ea
Alarm.25.Latch	10628	0x2984	Alarm.31.Block	10726	0x29e6
Alarm.25.Out	10633	0x2989	Alarm.31.Delay	10728	0x29e8
Alarm.25.Reference	10627	0x2983	Alarm.31.Hysteresis	10722	0x29e2
Alarm.25.Threshold	10625	0x2981	Alarm.31.Inhibit	10727	0x29e7
Alarm.25.Type	10624	0x2980	Alarm.31.Latch	10724	0x29e4
Alarm.26.Ack	10650	0x299a	Alarm.31.Out	10729	0x29e9
Alarm.26.Block	10646	0x2996	Alarm.31.Reference	10723	0x29e3
Alarm.26.Delay	10648	0x2998	Alarm.31.Threshold	10721	0x29e1
Alarm.26.Hysteresis	10642	0x2992	Alarm.31.Type	10720	0x29e0
Alarm.26.Inhibit	10647	0x2997	Alarm.32.Ack	10746	0x29fa
Alarm.26.Latch	10644	0x2994	Alarm.32.Block	10742	0x29f6
Alarm.26.Out	10649	0x2999	Alarm.32.Delay	10744	0x29f8
Alarm.26.Reference	10643	0x2993	Alarm.32.Hysteresis	10738	0x29f2
Alarm.26.Threshold	10641	0x2991	Alarm.32.Inhibit	10743	0x29f7
Alarm.26.Type	10640	0x2990	Alarm.32.Latch	10740	0x29f4
Alarm.27.Ack	10666	0x29aa	Alarm.32.Out	10745	0x29f9
Alarm.27.Block	10662	0x29a6	Alarm.32.Reference	10739	0x29f3
Alarm.27.Delay	10664	0x29a8	Alarm.32.Threshold	10737	0x29f1
Alarm.27.Hysteresis	10658	0x29a2	Alarm.32.Type	10736	0x29f0
Alarm.27.Inhibit	10663	0x29a7	AlmSummary.General.AnAlarmStatus1	10176	0x27c0
Alarm.27.Latch	10660	0x29a4	AlmSummary.General.AnAlarmStatus2	10177	0x27c1
Alarm.27.Out	10665	0x29a9	AlmSummary.General.AnAlarmStatus3	10178	0x27c2
Alarm.27.Reference	10659	0x29a3	AlmSummary.General.AnAlarmStatus4	10179	0x27c3
Alarm.27.Threshold	10657	0x29a1	AlmSummary.General.AnyAlarm	10213	0x27e5
Alarm.27.Type	10656	0x29a0	AlmSummary.General.CTAlarmStatus1	4192	0x1060
Alarm.28.Ack	10682	0x29ba	AlmSummary.General.CTAlarmStatus2	4193	0x1061
Alarm.28.Block	10678	0x29b6	AlmSummary.General.CTAlarmStatus3	4194	0x1062
Alarm.28.Delay	10680	0x29b8	AlmSummary.General.CTAlarmStatus4	4195	0x1063
Alarm.28.Hysteresis	10674	0x29b2	AlmSummary.General.DigAlarmStatus1	10188	0x27cc
Alarm.28.Inhibit	10679	0x29b7	AlmSummary.General.DigAlarmStatus2	10189	0x27cd
Alarm.28.Latch	10676	0x29b4	AlmSummary.General.DigAlarmStatus3	10190	0x27ce

MINI8 CONTROLLER: ENGINEERING HANDBOOK

Parameter Description / Modbus address	DEC	HEX	Parameter Description / Modbus address	DEC	HEX
AlmSummary.General.DigAlarmStatus4	10191	0x27cf	DigAlarm.7.Ack	11370	0x2c6a
AlmSummary.General.GlobalAck	10214	0x27e6	DigAlarm.7.Block	11366	0x2c66
AlmSummary.General.NewAlarm	10212	0x27e4	DigAlarm.7.Delay	11368	0x2c68
AlmSummary.General.NewCTAlarm	4196	0x1064	DigAlarm.7.Inhibit	11367	0x2c67
AlmSummary.General.RstNewAlarm	10215	0x27e7	DigAlarm.7.Latch	11364	0x2c64
AlmSummary.General.RstNewCTAlarm	4197	0x1065	DigAlarm.7.Out	11369	0x2c69
AlmSummary.General.SBrkAlarmStatus1	10200	0x27d8	DigAlarm.7.Type	11360	0x2c60
AlmSummary.General.SBrkAlarmStatus2	10201	0x27d9	DigAlarm.8.Ack	11386	0x2c7a
AlmSummary.General.SBrkAlarmStatus3	10202	0x27da	DigAlarm.8.Block	11382	0x2c76
AlmSummary.General.SBrkAlarmStatus4	10203	0x27db	DigAlarm.8.Delay	11384	0x2c78
BCDInput.1.BCDVal	5072	0x13d0	DigAlarm.8.Inhibit	11383	0x2c77
BCDInput.2.BCDVal	5073	0x13d1	DigAlarm.8.Latch	11380	0x2c74
Comms.FC.Ident	12963	0x32a3	DigAlarm.8.Out	11385	0x2c79
DigAlarm.1.Ack	11274	0x2c0a	DigAlarm.8.Type	11376	0x2c70
DigAlarm.1.Block	11270	0x2c06	DigAlarm.9.Ack	11402	0x2c8a
DigAlarm.1.Delay	11272	0x2c08	DigAlarm.9.Block	11398	0x2c86
DigAlarm.1.Inhibit	11271	0x2c07	DigAlarm.9.Delay	11400	0x2c88
DigAlarm.1.Latch	11268	0x2c04	DigAlarm.9.Inhibit	11399	0x2c87
DigAlarm.1.Out	11273	0x2c09	DigAlarm.9.Latch	11396	0x2c84
DigAlarm.1.Type	11264	0x2c00	DigAlarm.9.Out	11401	0x2c89
DigAlarm.2.Ack	11290	0x2c1a	DigAlarm.9.Type	11392	0x2c80
DigAlarm.2.Block	11286	0x2c16	DigAlarm.10.Ack	11418	0x2c9a
DigAlarm.2.Delay	11288	0x2c18	DigAlarm.10.Block	11414	0x2c96
DigAlarm.2.Inhibit	11287	0x2c17	DigAlarm.10.Delay	11416	0x2c98
DigAlarm.2.Latch	11284	0x2c14	DigAlarm.10.Inhibit	11415	0x2c97
DigAlarm.2.Out	11289	0x2c19	DigAlarm.10.Latch	11412	0x2c94
DigAlarm.2.Type	11280	0x2c10	DigAlarm.10.Out	11417	0x2c99
DigAlarm.3.Ack	11306	0x2c2a	DigAlarm.10.Type	11408	0x2c90
DigAlarm.3.Block	11302	0x2c26	DigAlarm.11.Ack	11434	0x2caa
DigAlarm.3.Delay	11304	0x2c28	DigAlarm.11.Block	11430	0x2ca6
DigAlarm.3.Inhibit	11303	0x2c27	DigAlarm.11.Delay	11432	0x2ca8
DigAlarm.3.Latch	11300	0x2c24	DigAlarm.11.Inhibit	11431	0x2ca7
DigAlarm.3.Out	11305	0x2c29	DigAlarm.11.Latch	11428	0x2ca4
DigAlarm.3.Type	11296	0x2c20	DigAlarm.11.Out	11433	0x2ca9
DigAlarm.4.Ack	11322	0x2c3a	DigAlarm.11.Type	11424	0x2ca0
DigAlarm.4.Block	11318	0x2c36	DigAlarm.12.Ack	11450	0x2cba
DigAlarm.4.Delay	11320	0x2c38	DigAlarm.12.Block	11446	0x2cb6
DigAlarm.4.Inhibit	11319	0x2c37	DigAlarm.12.Delay	11448	0x2cb8
DigAlarm.4.Latch	11316	0x2c34	DigAlarm.12.Inhibit	11447	0x2cb7
DigAlarm.4.Out	11321	0x2c39	DigAlarm.12.Latch	11444	0x2cb4
DigAlarm.4.Type	11312	0x2c30	DigAlarm.12.Out	11449	0x2cb9
DigAlarm.5.Ack	11338	0x2c4a	DigAlarm.12.Type	11440	0x2cb0
DigAlarm.5.Block	11334	0x2c46	DigAlarm.13.Ack	11466	0x2cca
DigAlarm.5.Delay	11336	0x2c48	DigAlarm.13.Block	11462	0x2cc6
DigAlarm.5.Inhibit	11335	0x2c47	DigAlarm.13.Delay	11464	0x2cc8
DigAlarm.5.Latch	11332	0x2c44	DigAlarm.13.Inhibit	11463	0x2cc7
DigAlarm.5.Out	11337	0x2c49	DigAlarm.13.Latch	11460	0x2cc4
DigAlarm.5.Type	11328	0x2c40	DigAlarm.13.Out	11465	0x2cc9
DigAlarm.6.Ack	11354	0x2c5a	DigAlarm.13.Type	11456	0x2cc0
DigAlarm.6.Block	11350	0x2c56	DigAlarm.14.Ack	11482	0x2cda
DigAlarm.6.Delay	11352	0x2c58	DigAlarm.14.Block	11478	0x2cd6
DigAlarm.6.Inhibit	11351	0x2c57	DigAlarm.14.Delay	11480	0x2cd8
DigAlarm.6.Latch	11348	0x2c54	DigAlarm.14.Inhibit	11479	0x2cd7
DigAlarm.6.Out	11353	0x2c59	DigAlarm.14.Latch	11476	0x2cd4
DigAlarm.6.Type	11344	0x2c50	DigAlarm.14.Out	11481	0x2cd9

MINI8 CONTROLLER: ENGINEERING HANDBOOK

Parameter Description / Modbus address	DEC	HEX	Parameter Description / Modbus address	DEC	HEX
DigAlarm.14.Type	11472	0x2cd0	DigAlarm.22.Type	11600	0x2d50
DigAlarm.15.Ack	11498	0x2cea	DigAlarm.23.Ack	11626	0x2d6a
DigAlarm.15.Block	11494	0x2ce6	DigAlarm.23.Block	11622	0x2d66
DigAlarm.15.Delay	11496	0x2ce8	DigAlarm.23.Delay	11624	0x2d68
DigAlarm.15.Inhibit	11495	0x2ce7	DigAlarm.23.Inhibit	11623	0x2d67
DigAlarm.15.Latch	11492	0x2ce4	DigAlarm.23.Latch	11620	0x2d64
DigAlarm.15.Out	11497	0x2ce9	DigAlarm.23.Out	11625	0x2d69
DigAlarm.15.Type	11488	0x2ce0	DigAlarm.23.Type	11616	0x2d60
DigAlarm.16.Ack	11514	0x2cfa	DigAlarm.24.Ack	11642	0x2d7a
DigAlarm.16.Block	11510	0x2cf6	DigAlarm.24.Block	11638	0x2d76
DigAlarm.16.Delay	11512	0x2cf8	DigAlarm.24.Delay	11640	0x2d78
DigAlarm.16.Inhibit	11511	0x2cf7	DigAlarm.24.Inhibit	11639	0x2d77
DigAlarm.16.Latch	11508	0x2cf4	DigAlarm.24.Latch	11636	0x2d74
DigAlarm.16.Out	11513	0x2cf9	DigAlarm.24.Out	11641	0x2d79
DigAlarm.16.Type	11504	0x2cf0	DigAlarm.24.Type	11632	0x2d70
DigAlarm.17.Ack	11530	0x2d0a	DigAlarm.25.Ack	11658	0x2d8a
DigAlarm.17.Block	11526	0x2d06	DigAlarm.25.Block	11654	0x2d86
DigAlarm.17.Delay	11528	0x2d08	DigAlarm.25.Delay	11656	0x2d88
DigAlarm.17.Inhibit	11527	0x2d07	DigAlarm.25.Inhibit	11655	0x2d87
DigAlarm.17.Latch	11524	0x2d04	DigAlarm.25.Latch	11652	0x2d84
DigAlarm.17.Out	11529	0x2d09	DigAlarm.25.Out	11657	0x2d89
DigAlarm.17.Type	11520	0x2d00	DigAlarm.25.Type	11648	0x2d80
DigAlarm.18.Ack	11546	0x2d1a	DigAlarm.26.Ack	11674	0x2d9a
DigAlarm.18.Block	11542	0x2d16	DigAlarm.26.Block	11670	0x2d96
DigAlarm.18.Delay	11544	0x2d18	DigAlarm.26.Delay	11672	0x2d98
DigAlarm.18.Inhibit	11543	0x2d17	DigAlarm.26.Inhibit	11671	0x2d97
DigAlarm.18.Latch	11540	0x2d14	DigAlarm.26.Latch	11668	0x2d94
DigAlarm.18.Out	11545	0x2d19	DigAlarm.26.Out	11673	0x2d99
DigAlarm.18.Type	11536	0x2d10	DigAlarm.26.Type	11664	0x2d90
DigAlarm.19.Ack	11562	0x2d2a	DigAlarm.27.Ack	11690	0x2daa
DigAlarm.19.Block	11558	0x2d26	DigAlarm.27.Block	11686	0x2da6
DigAlarm.19.Delay	11560	0x2d28	DigAlarm.27.Delay	11688	0x2da8
DigAlarm.19.Inhibit	11559	0x2d27	DigAlarm.27.Inhibit	11687	0x2da7
DigAlarm.19.Latch	11556	0x2d24	DigAlarm.27.Latch	11684	0x2da4
DigAlarm.19.Out	11561	0x2d29	DigAlarm.27.Out	11689	0x2da9
DigAlarm.19.Type	11552	0x2d20	DigAlarm.27.Type	11680	0x2da0
DigAlarm.20.Ack	11578	0x2d3a	DigAlarm.28.Ack	11706	0x2dba
DigAlarm.20.Block	11574	0x2d36	DigAlarm.28.Block	11702	0x2db6
DigAlarm.20.Delay	11576	0x2d38	DigAlarm.28.Delay	11704	0x2db8
DigAlarm.20.Inhibit	11575	0x2d37	DigAlarm.28.Inhibit	11703	0x2db7
DigAlarm.20.Latch	11572	0x2d34	DigAlarm.28.Latch	11700	0x2db4
DigAlarm.20.Out	11577	0x2d39	DigAlarm.28.Out	11705	0x2db9
DigAlarm.20.Type	11568	0x2d30	DigAlarm.28.Type	11696	0x2db0
DigAlarm.21.Ack	11594	0x2d4a	DigAlarm.29.Ack	11722	0x2dca
DigAlarm.21.Block	11590	0x2d46	DigAlarm.29.Block	11718	0x2dc6
DigAlarm.21.Delay	11592	0x2d48	DigAlarm.29.Delay	11720	0x2dc8
DigAlarm.21.Inhibit	11591	0x2d47	DigAlarm.29.Inhibit	11719	0x2dc7
DigAlarm.21.Latch	11588	0x2d44	DigAlarm.29.Latch	11716	0x2dc4
DigAlarm.21.Out	11593	0x2d49	DigAlarm.29.Out	11721	0x2dc9
DigAlarm.21.Type	11584	0x2d40	DigAlarm.29.Type	11712	0x2dc0
DigAlarm.22.Ack	11610	0x2d5a	DigAlarm.30.Ack	11738	0x2dda
DigAlarm.22.Block	11606	0x2d56	DigAlarm.30.Block	11734	0x2dd6
DigAlarm.22.Delay	11608	0x2d58	DigAlarm.30.Delay	11736	0x2dd8
DigAlarm.22.Inhibit	11607	0x2d57	DigAlarm.30.Inhibit	11735	0x2dd7
DigAlarm.22.Latch	11604	0x2d54	DigAlarm.30.Latch	11732	0x2dd4
DigAlarm.22.Out	11609	0x2d59	DigAlarm.30.Out	11737	0x2dd9

MINI8 CONTROLLER: ENGINEERING HANDBOOK

Parameter Description / Modbus address	DEC	HEX
DigAlarm.30.Type	11728	0x2dd0
DigAlarm.31.Ack	11754	0x2dea
DigAlarm.31.Block	11750	0x2de6
DigAlarm.31.Delay	11752	0x2de8
DigAlarm.31.Inhibit	11751	0x2de7
DigAlarm.31.Latch	11748	0x2de4
DigAlarm.31.Out	11753	0x2de9
DigAlarm.31.Type	11744	0x2de0
DigAlarm.32.Ack	11770	0x2dfa
DigAlarm.32.Block	11766	0x2df6
DigAlarm.32.Delay	11768	0x2df8
DigAlarm.32.Inhibit	11767	0x2df7
DigAlarm.32.Latch	11764	0x2df4
DigAlarm.32.Out	11769	0x2df9
DigAlarm.32.Type	11760	0x2df0
Humidity.DewPoint	13317	0x3405
Humidity.DryTemp	13318	0x3406
Humidity.Pressure	13313	0x3401
Humidity.PsychroConst	13315	0x3403
Humidity.RelHumid	13316	0x3404
Humidity.Resolution	13320	0x3408
Humidity.SBrk	13314	0x3402
Humidity.WetOffset	13312	0x3400
Humidity.WetTemp	13319	0x3407
Instrument.Diagnostics.CntrlOverrun	4737	0x1281
Instrument.Diagnostics.ErrCount	4736	0x1280
Instrument.Diagnostics.PSUident	13027	0x32e3
Instrument.InstInfo.CompanyID	121	0x0079
Instrument.InstInfo.InstType	122	0x007a
Instrument.InstInfo.Version	107	0x006b
Instrument.Options.Units	4738	0x1282
IO.CurrentMonitor.Config.CalibrateCT1	4170	0x104a
IO.CurrentMonitor.Config.CalibrateCT2	4171	0x104b
IO.CurrentMonitor.Config.CalibrateCT3	4172	0x104c
IO.CurrentMonitor.Config.Commission	4096	0x1000
IO.CurrentMonitor.Config.CommissionStatus	4097	0x1001
IO.CurrentMonitor.Config.CT1Range	4103	0x1007
IO.CurrentMonitor.Config.CT1Resolution	4198	0x1066
IO.CurrentMonitor.Config.CT2Range	4104	0x1008
IO.CurrentMonitor.Config.CT2Resolution	4199	0x1067
IO.CurrentMonitor.Config.CT3Range	4105	0x1009
IO.CurrentMonitor.Config.CT3Resolution	4200	0x1068
IO.CurrentMonitor.Config.Inhibit	4099	0x1003
IO.CurrentMonitor.Config.Interval	4098	0x1002
IO.CurrentMonitor.Config.Load1CTInput	4107	0x100b
IO.CurrentMonitor.Config.Load1DrivenBy	4106	0x100a
IO.CurrentMonitor.Config.Load1OCFthreshold	4109	0x100d
IO.CurrentMonitor.Config.Load1PLFthreshold	4108	0x100c
IO.CurrentMonitor.Config.Load1Resolution	4201	0x1069
IO.CurrentMonitor.Config.Load2CTInput	4111	0x100f
IO.CurrentMonitor.Config.Load2DrivenBy	4110	0x100e
IO.CurrentMonitor.Config.Load2OCFthreshold	4113	0x1011
IO.CurrentMonitor.Config.Load2PLFthreshold	4112	0x1010
IO.CurrentMonitor.Config.Load2Resolution	4202	0x106a
IO.CurrentMonitor.Config.Load3CTInput	4115	0x1013

Parameter Description / Modbus address	DEC	HEX
IO.CurrentMonitor.Config.Load3DrivenBy	4114	0x1012
IO.CurrentMonitor.Config.Load3OCFthreshold	4117	0x1015
IO.CurrentMonitor.Config.Load3PLFthreshold	4116	0x1014
IO.CurrentMonitor.Config.Load3Resolution	4203	0x106b
IO.CurrentMonitor.Config.Load4CTInput	4119	0x1017
IO.CurrentMonitor.Config.Load4DrivenBy	4118	0x1016
IO.CurrentMonitor.Config.Load4OCFthreshold	4121	0x1019
IO.CurrentMonitor.Config.Load4PLFthreshold	4120	0x1018
IO.CurrentMonitor.Config.Load4Resolution	4204	0x106c
IO.CurrentMonitor.Config.Load5CTInput	4123	0x101b
IO.CurrentMonitor.Config.Load5DrivenBy	4122	0x101a
IO.CurrentMonitor.Config.Load5OCFthreshold	4125	0x101d
IO.CurrentMonitor.Config.Load5PLFthreshold	4124	0x101c
IO.CurrentMonitor.Config.Load5Resolution	4205	0x106d
IO.CurrentMonitor.Config.Load6CTInput	4127	0x101f
IO.CurrentMonitor.Config.Load6DrivenBy	4126	0x101e
IO.CurrentMonitor.Config.Load6OCFthreshold	4129	0x1021
IO.CurrentMonitor.Config.Load6PLFthreshold	4128	0x1020
IO.CurrentMonitor.Config.Load6Resolution	4206	0x106e
IO.CurrentMonitor.Config.Load7CTInput	4131	0x1023
IO.CurrentMonitor.Config.Load7DrivenBy	4130	0x1022
IO.CurrentMonitor.Config.Load7OCFthreshold	4133	0x1025
IO.CurrentMonitor.Config.Load7PLFthreshold	4132	0x1024
IO.CurrentMonitor.Config.Load7Resolution	4207	0x106f
IO.CurrentMonitor.Config.Load8CTInput	4135	0x1027
IO.CurrentMonitor.Config.Load8DrivenBy	4134	0x1026
IO.CurrentMonitor.Config.Load8OCFthreshold	4137	0x1029
IO.CurrentMonitor.Config.Load8PLFthreshold	4136	0x1028
IO.CurrentMonitor.Config.Load8Resolution	4208	0x1070
IO.CurrentMonitor.Config.Load9CTInput	4139	0x102b
IO.CurrentMonitor.Config.Load9DrivenBy	4138	0x102a
IO.CurrentMonitor.Config.Load9OCFthreshold	4141	0x102d
IO.CurrentMonitor.Config.Load9PLFthreshold	4140	0x102c
IO.CurrentMonitor.Config.Load9Resolution	4209	0x1071
IO.CurrentMonitor.Config.Load10CTInput	4143	0x102f
IO.CurrentMonitor.Config.Load10DrivenBy	4142	0x102e
IO.CurrentMonitor.Config.Load10OCFthreshold	4145	0x1031
IO.CurrentMonitor.Config.Load10PLFthreshold	4144	0x1030
IO.CurrentMonitor.Config.Load10Resolution	4210	0x1072
IO.CurrentMonitor.Config.Load11CTInput	4147	0x1033
IO.CurrentMonitor.Config.Load11DrivenBy	4146	0x1032
IO.CurrentMonitor.Config.Load11OCFthreshold	4149	0x1035
IO.CurrentMonitor.Config.Load11PLFthreshold	4148	0x1034
IO.CurrentMonitor.Config.Load11Resolution	4211	0x1073
IO.CurrentMonitor.Config.Load12CTInput	4151	0x1037
IO.CurrentMonitor.Config.Load12DrivenBy	4150	0x1036
IO.CurrentMonitor.Config.Load12OCFthreshold	4153	0x1039
IO.CurrentMonitor.Config.Load12PLFthreshold	4152	0x1038
IO.CurrentMonitor.Config.Load12Resolution	4212	0x1074
IO.CurrentMonitor.Config.Load13CTInput	4155	0x103b
IO.CurrentMonitor.Config.Load13DrivenBy	4154	0x103a
IO.CurrentMonitor.Config.Load13OCFthreshold	4157	0x103d
IO.CurrentMonitor.Config.Load13PLFthreshold	4156	0x103c
IO.CurrentMonitor.Config.Load13Resolution	4213	0x1075
IO.CurrentMonitor.Config.Load14CTInput	4159	0x103f

MINI8 CONTROLLER: ENGINEERING HANDBOOK

Parameter Description / Modbus address	DEC	HEX	Parameter Description / Modbus address	DEC	HEX
IO.CurrentMonitor.Config.Load14DrivenBy	4158	0x103e	IO.Mod.3.HiPoint	4390	0x1126
IO.CurrentMonitor.Config.Load14OCFthreshold	4161	0x1041	IO.Mod.3.LoOffset	4358	0x1106
IO.CurrentMonitor.Config.Load14PLFthreshold	4160	0x1040	IO.Mod.3.LoPoint	4326	0x10e6
IO.CurrentMonitor.Config.Load14Resolution	4214	0x1076	IO.Mod.3.MinOnTime	4294	0x10c6
IO.CurrentMonitor.Config.Load15CTInput	4163	0x1043	IO.Mod.3.PV	4230	0x1086
IO.CurrentMonitor.Config.Load15DrivenBy	4162	0x1042	IO.Mod.4.AlarmAck	4263	0x10a7
IO.CurrentMonitor.Config.Load15OCFthreshold	4165	0x1045	IO.Mod.4.HiOffset	4423	0x1147
IO.CurrentMonitor.Config.Load15PLFthreshold	4164	0x1044	IO.Mod.4.HiPoint	4391	0x1127
IO.CurrentMonitor.Config.Load15Resolution	4215	0x1077	IO.Mod.4.LoOffset	4359	0x1107
IO.CurrentMonitor.Config.Load16CTInput	4167	0x1047	IO.Mod.4.LoPoint	4327	0x10e7
IO.CurrentMonitor.Config.Load16DrivenBy	4166	0x1046	IO.Mod.4.MinOnTime	4295	0x10c7
IO.CurrentMonitor.Config.Load16OCFthreshold	4169	0x1049	IO.Mod.4.PV	4231	0x1087
IO.CurrentMonitor.Config.Load16PLFthreshold	4168	0x1048	IO.Mod.5.AlarmAck	4264	0x10a8
IO.CurrentMonitor.Config.Load16Resolution	4216	0x1078	IO.Mod.5.HiOffset	4424	0x1148
IO.CurrentMonitor.Config.MaxLeakPh1	4100	0x1004	IO.Mod.5.HiPoint	4392	0x1128
IO.CurrentMonitor.Config.MaxLeakPh2	4101	0x1005	IO.Mod.5.LoOffset	4360	0x1108
IO.CurrentMonitor.Config.MaxLeakPh3	4102	0x1006	IO.Mod.5.LoPoint	4328	0x10e8
IO.CurrentMonitor.Status.Load1Current	4173	0x104d	IO.Mod.5.MinOnTime	4296	0x10c8
IO.CurrentMonitor.Status.Load2Current	4174	0x104e	IO.Mod.5.PV	4232	0x1088
IO.CurrentMonitor.Status.Load3Current	4175	0x104f	IO.Mod.6.AlarmAck	4265	0x10a9
IO.CurrentMonitor.Status.Load4Current	4176	0x1050	IO.Mod.6.HiOffset	4425	0x1149
IO.CurrentMonitor.Status.Load5Current	4177	0x1051	IO.Mod.6.HiPoint	4393	0x1129
IO.CurrentMonitor.Status.Load6Current	4178	0x1052	IO.Mod.6.LoOffset	4361	0x1109
IO.CurrentMonitor.Status.Load7Current	4179	0x1053	IO.Mod.6.LoPoint	4329	0x10e9
IO.CurrentMonitor.Status.Load8Current	4180	0x1054	IO.Mod.6.MinOnTime	4297	0x10c9
IO.CurrentMonitor.Status.Load9Current	4181	0x1055	IO.Mod.6.PV	4233	0x1089
IO.CurrentMonitor.Status.Load10Current	4182	0x1056	IO.Mod.7.AlarmAck	4266	0x10aa
IO.CurrentMonitor.Status.Load11Current	4183	0x1057	IO.Mod.7.HiOffset	4426	0x114a
IO.CurrentMonitor.Status.Load12Current	4184	0x1058	IO.Mod.7.HiPoint	4394	0x112a
IO.CurrentMonitor.Status.Load13Current	4185	0x1059	IO.Mod.7.LoOffset	4362	0x110a
IO.CurrentMonitor.Status.Load14Current	4186	0x105a	IO.Mod.7.LoPoint	4330	0x10ea
IO.CurrentMonitor.Status.Load15Current	4187	0x105b	IO.Mod.7.MinOnTime	4298	0x10ca
IO.CurrentMonitor.Status.Load16Current	4188	0x105c	IO.Mod.7.PV	4234	0x108a
IO.CurrentMonitor.Status.Ph1AllOff	4189	0x105d	IO.Mod.8.AlarmAck	4267	0x10ab
IO.CurrentMonitor.Status.Ph2AllOff	4190	0x105e	IO.Mod.8.HiOffset	4427	0x114b
IO.CurrentMonitor.Status.Ph3AllOff	4191	0x105f	IO.Mod.8.HiPoint	4395	0x112b
IO.FixedIO.A.PV	4226	0x1082	IO.Mod.8.LoOffset	4363	0x110b
IO.FixedIO.B.PV	4227	0x1083	IO.Mod.8.LoPoint	4331	0x10eb
IO.FixedIO.D1.PV	4224	0x1080	IO.Mod.8.MinOnTime	4299	0x10cb
IO.FixedIO.D2.PV	4225	0x1081	IO.Mod.8.PV	4235	0x108b
IO.Mod.1.AlarmAck	4260	0x10a4	IO.Mod.9.AlarmAck	4268	0x10ac
IO.Mod.1.HiOffset	4420	0x1144	IO.Mod.9.HiOffset	4428	0x114c
IO.Mod.1.HiPoint	4388	0x1124	IO.Mod.9.HiPoint	4396	0x112c
IO.Mod.1.LoOffset	4356	0x1104	IO.Mod.9.LoOffset	4364	0x110c
IO.Mod.1.LoPoint	4324	0x10e4	IO.Mod.9.LoPoint	4332	0x10ec
IO.Mod.1.MinOnTime	4292	0x10c4	IO.Mod.9.MinOnTime	4300	0x10cc
IO.Mod.1.PV	4228	0x1084	IO.Mod.9.PV	4236	0x108c
IO.Mod.2.AlarmAck	4261	0x10a5	IO.Mod.10.AlarmAck	4269	0x10ad
IO.Mod.2.HiOffset	4421	0x1145	IO.Mod.10.HiOffset	4429	0x114d
IO.Mod.2.HiPoint	4389	0x1125	IO.Mod.10.HiPoint	4397	0x112d
IO.Mod.2.LoOffset	4357	0x1105	IO.Mod.10.LoOffset	4365	0x110d
IO.Mod.2.LoPoint	4325	0x10e5	IO.Mod.10.LoPoint	4333	0x10ed
IO.Mod.2.MinOnTime	4293	0x10c5	IO.Mod.10.MinOnTime	4301	0x10cd
IO.Mod.2.PV	4229	0x1085	IO.Mod.10.PV	4237	0x108d
IO.Mod.3.AlarmAck	4262	0x10a6	IO.Mod.11.AlarmAck	4270	0x10ae
IO.Mod.3.HiOffset	4422	0x1146	IO.Mod.11.HiOffset	4430	0x114e

MINI8 CONTROLLER: ENGINEERING HANDBOOK

Parameter Description / Modbus address	DEC	HEX	Parameter Description / Modbus address	DEC	HEX
IO.Mod.11.HiPoint	4398	0x112e	IO.Mod.19.HiOffset	4438	0x1156
IO.Mod.11.LoOffset	4366	0x110e	IO.Mod.19.HiPoint	4406	0x1136
IO.Mod.11.LoPoint	4334	0x10ee	IO.Mod.19.LoOffset	4374	0x1116
IO.Mod.11.MinOnTime	4302	0x10ce	IO.Mod.19.LoPoint	4342	0x10f6
IO.Mod.11.PV	4238	0x108e	IO.Mod.19.MinOnTime	4310	0x10d6
IO.Mod.12.AlarmAck	4271	0x10af	IO.Mod.19.PV	4246	0x1096
IO.Mod.12.HiOffset	4431	0x114f	IO.Mod.20.AlarmAck	4279	0x10b7
IO.Mod.12.HiPoint	4399	0x112f	IO.Mod.20.HiOffset	4439	0x1157
IO.Mod.12.LoOffset	4367	0x110f	IO.Mod.20.HiPoint	4407	0x1137
IO.Mod.12.LoPoint	4335	0x10ef	IO.Mod.20.LoOffset	4375	0x1117
IO.Mod.12.MinOnTime	4303	0x10cf	IO.Mod.20.LoPoint	4343	0x10f7
IO.Mod.12.PV	4239	0x108f	IO.Mod.20.MinOnTime	4311	0x10d7
IO.Mod.13.AlarmAck	4272	0x10b0	IO.Mod.20.PV	4247	0x1097
IO.Mod.13.HiOffset	4432	0x1150	IO.Mod.21.AlarmAck	4280	0x10b8
IO.Mod.13.HiPoint	4400	0x1130	IO.Mod.21.HiOffset	4440	0x1158
IO.Mod.13.LoOffset	4368	0x1110	IO.Mod.21.HiPoint	4408	0x1138
IO.Mod.13.LoPoint	4336	0x10f0	IO.Mod.21.LoOffset	4376	0x1118
IO.Mod.13.MinOnTime	4304	0x10d0	IO.Mod.21.LoPoint	4344	0x10f8
IO.Mod.13.PV	4240	0x1090	IO.Mod.21.MinOnTime	4312	0x10d8
IO.Mod.14.AlarmAck	4273	0x10b1	IO.Mod.21.PV	4248	0x1098
IO.Mod.14.HiOffset	4433	0x1151	IO.Mod.22.AlarmAck	4281	0x10b9
IO.Mod.14.HiPoint	4401	0x1131	IO.Mod.22.HiOffset	4441	0x1159
IO.Mod.14.LoOffset	4369	0x1111	IO.Mod.22.HiPoint	4409	0x1139
IO.Mod.14.LoPoint	4337	0x10f1	IO.Mod.22.LoOffset	4377	0x1119
IO.Mod.14.MinOnTime	4305	0x10d1	IO.Mod.22.LoPoint	4345	0x10f9
IO.Mod.14.PV	4241	0x1091	IO.Mod.22.MinOnTime	4313	0x10d9
IO.Mod.15.AlarmAck	4274	0x10b2	IO.Mod.22.PV	4249	0x1099
IO.Mod.15.HiOffset	4434	0x1152	IO.Mod.23.AlarmAck	4282	0x10ba
IO.Mod.15.HiPoint	4402	0x1132	IO.Mod.23.HiOffset	4442	0x115a
IO.Mod.15.LoOffset	4370	0x1112	IO.Mod.23.HiPoint	4410	0x113a
IO.Mod.15.LoPoint	4338	0x10f2	IO.Mod.23.LoOffset	4378	0x111a
IO.Mod.15.MinOnTime	4306	0x10d2	IO.Mod.23.LoPoint	4346	0x10fa
IO.Mod.15.PV	4242	0x1092	IO.Mod.23.MinOnTime	4314	0x10da
IO.Mod.16.AlarmAck	4275	0x10b3	IO.Mod.23.PV	4250	0x109a
IO.Mod.16.HiOffset	4435	0x1153	IO.Mod.24.AlarmAck	4283	0x10bb
IO.Mod.16.HiPoint	4403	0x1133	IO.Mod.24.HiOffset	4443	0x115b
IO.Mod.16.LoOffset	4371	0x1113	IO.Mod.24.HiPoint	4411	0x113b
IO.Mod.16.LoPoint	4339	0x10f3	IO.Mod.24.LoOffset	4379	0x111b
IO.Mod.16.MinOnTime	4307	0x10d3	IO.Mod.24.LoPoint	4347	0x10fb
IO.Mod.16.PV	4243	0x1093	IO.Mod.24.MinOnTime	4315	0x10db
IO.Mod.17.AlarmAck	4276	0x10b4	IO.Mod.24.PV	4251	0x109b
IO.Mod.17.HiOffset	4436	0x1154	IO.Mod.25.AlarmAck	4284	0x10bc
IO.Mod.17.HiPoint	4404	0x1134	IO.Mod.25.HiOffset	4444	0x115c
IO.Mod.17.LoOffset	4372	0x1114	IO.Mod.25.HiPoint	4412	0x113c
IO.Mod.17.LoPoint	4340	0x10f4	IO.Mod.25.LoOffset	4380	0x111c
IO.Mod.17.MinOnTime	4308	0x10d4	IO.Mod.25.LoPoint	4348	0x10fc
IO.Mod.17.PV	4244	0x1094	IO.Mod.25.MinOnTime	4316	0x10dc
IO.Mod.18.AlarmAck	4277	0x10b5	IO.Mod.25.PV	4252	0x109c
IO.Mod.18.HiOffset	4437	0x1155	IO.Mod.26.AlarmAck	4285	0x10bd
IO.Mod.18.HiPoint	4405	0x1135	IO.Mod.26.HiOffset	4445	0x115d
IO.Mod.18.LoOffset	4373	0x1115	IO.Mod.26.HiPoint	4413	0x113d
IO.Mod.18.LoPoint	4341	0x10f5	IO.Mod.26.LoOffset	4381	0x111d
IO.Mod.18.MinOnTime	4309	0x10d5	IO.Mod.26.LoPoint	4349	0x10fd
IO.Mod.18.PV	4245	0x1095	IO.Mod.26.MinOnTime	4317	0x10dd
IO.Mod.19.AlarmAck	4278	0x10b6	IO.Mod.26.PV	4253	0x109d

MINI8 CONTROLLER: ENGINEERING HANDBOOK

Parameter Description / Modbus address	DEC	HEX	Parameter Description / Modbus address	DEC	HEX
IO.Mod.27.AlarmAck	4286	0x10be	Lgc2.1.In1	4822	0x12d6
IO.Mod.27.HiOffset	4446	0x115e	Lgc2.1.In2	4823	0x12d7
IO.Mod.27.HiPoint	4414	0x113e	Lgc2.1.Out	4824	0x12d8
IO.Mod.27.LoOffset	4382	0x111e	Lgc2.2.In1	4825	0x12d9
IO.Mod.27.LoPoint	4350	0x10fe	Lgc2.2.In2	4826	0x12da
IO.Mod.27.MinOnTime	4318	0x10de	Lgc2.2.Out	4827	0x12db
IO.Mod.27.PV	4254	0x109e	Lgc2.3.In1	4828	0x12dc
IO.Mod.28.AlarmAck	4287	0x10bf	Lgc2.3.In2	4829	0x12dd
IO.Mod.28.HiOffset	4447	0x115f	Lgc2.3.Out	4830	0x12de
IO.Mod.28.HiPoint	4415	0x113f	Lgc2.4.In1	4831	0x12df
IO.Mod.28.LoOffset	4383	0x111f	Lgc2.4.In2	4832	0x12e0
IO.Mod.28.LoPoint	4351	0x10ff	Lgc2.4.Out	4833	0x12e1
IO.Mod.28.MinOnTime	4319	0x10df	Lgc2.5.In1	4834	0x12e2
IO.Mod.28.PV	4255	0x109f	Lgc2.5.In2	4835	0x12e3
IO.Mod.29.AlarmAck	4288	0x10c0	Lgc2.5.Out	4836	0x12e4
IO.Mod.29.HiOffset	4448	0x1160	Lgc2.6.In1	4837	0x12e5
IO.Mod.29.HiPoint	4416	0x1140	Lgc2.6.In2	4838	0x12e6
IO.Mod.29.LoOffset	4384	0x1120	Lgc2.6.Out	4839	0x12e7
IO.Mod.29.LoPoint	4352	0x1100	Lgc2.7.In1	4840	0x12e8
IO.Mod.29.MinOnTime	4320	0x10e0	Lgc2.7.In2	4841	0x12e9
IO.Mod.29.PV	4256	0x10a0	Lgc2.7.Out	4842	0x12ea
IO.Mod.30.AlarmAck	4289	0x10c1	Lgc2.8.In1	4843	0x12eb
IO.Mod.30.HiOffset	4449	0x1161	Lgc2.8.In2	4844	0x12ec
IO.Mod.30.HiPoint	4417	0x1141	Lgc2.8.Out	4845	0x12ed
IO.Mod.30.LoOffset	4385	0x1121	Lgc2.9.In1	4846	0x12ee
IO.Mod.30.LoPoint	4353	0x1101	Lgc2.9.In2	4847	0x12ef
IO.Mod.30.MinOnTime	4321	0x10e1	Lgc2.9.Out	4848	0x12f0
IO.Mod.30.PV	4257	0x10a1	Lgc2.10.In1	4849	0x12f1
IO.Mod.31.AlarmAck	4290	0x10c2	Lgc2.10.In2	4850	0x12f2
IO.Mod.31.HiOffset	4450	0x1162	Lgc2.10.Out	4851	0x12f3
IO.Mod.31.HiPoint	4418	0x1142	Lgc2.11.In1	4852	0x12f4
IO.Mod.31.LoOffset	4386	0x1122	Lgc2.11.In2	4853	0x12f5
IO.Mod.31.LoPoint	4354	0x1102	Lgc2.11.Out	4854	0x12f6
IO.Mod.31.MinOnTime	4322	0x10e2	Lgc2.12.In1	4855	0x12f7
IO.Mod.31.PV	4258	0x10a2	Lgc2.12.In2	4856	0x12f8
IO.Mod.32.AlarmAck	4291	0x10c3	Lgc2.12.Out	4857	0x12f9
IO.Mod.32.HiOffset	4451	0x1163	Lgc2.13.In1	4858	0x12fa
IO.Mod.32.HiPoint	4419	0x1143	Lgc2.13.In2	4859	0x12fb
IO.Mod.32.LoOffset	4387	0x1123	Lgc2.13.Out	4860	0x12fc
IO.Mod.32.LoPoint	4355	0x1103	Lgc2.14.In1	4861	0x12fd
IO.Mod.32.MinOnTime	4323	0x10e3	Lgc2.14.In2	4862	0x12fe
IO.Mod.32.PV	4259	0x10a3	Lgc2.14.Out	4863	0x12ff
IO.ModIDs.Module1	12707	0x31a3	Lgc2.15.In1	4864	0x1300
IO.ModIDs.Module2	12771	0x31e3	Lgc2.15.In2	4865	0x1301
IO.ModIDs.Module3	12835	0x3223	Lgc2.15.Out	4866	0x1302
IO.ModIDs.Module4	12899	0x3263	Lgc2.16.In1	4867	0x1303
IPMonitor.1.Max	4915	0x1333	Lgc2.16.In2	4868	0x1304
IPMonitor.1.Min	4916	0x1334	Lgc2.16.Out	4869	0x1305
IPMonitor.1.Reset	4919	0x1337	Lgc2.17.In1	4870	0x1306
IPMonitor.1.Threshold	4917	0x1335	Lgc2.17.In2	4871	0x1307
IPMonitor.1.TimeAbove	4918	0x1336	Lgc2.17.Out	4872	0x1308
IPMonitor.2.Max	4920	0x1338	Lgc2.18.In1	4873	0x1309
IPMonitor.2.Min	4921	0x1339	Lgc2.18.In2	4874	0x130a
IPMonitor.2.Reset	4924	0x133c	Lgc2.18.Out	4875	0x130b
IPMonitor.2.Threshold	4922	0x133a	Lgc2.19.In1	4876	0x130c
IPMonitor.2.TimeAbove	4923	0x133b	Lgc2.19.In2	4877	0x130d

MINI8 CONTROLLER: ENGINEERING HANDBOOK

Parameter Description / Modbus address	DEC	HEX	Parameter Description / Modbus address	DEC	HEX
Lgc2.19.Out	4878	0x130e	Lin16.In3	4931	0x1343
Lgc2.20.In1	4879	0x130f	Lin16.In4	4932	0x1344
Lgc2.20.In2	4880	0x1310	Lin16.In5	4933	0x1345
Lgc2.20.Out	4881	0x1311	Lin16.In6	4934	0x1346
Lgc2.21.In1	4882	0x1312	Lin16.In7	4935	0x1347
Lgc2.21.In2	4883	0x1313	Lin16.In8	4936	0x1348
Lgc2.21.Out	4884	0x1314	Lin16.In9	4937	0x1349
Lgc2.22.In1	4885	0x1315	Lin16.In10	4938	0x134a
Lgc2.22.In2	4886	0x1316	Lin16.In11	4939	0x134b
Lgc2.22.Out	4887	0x1317	Lin16.In12	4940	0x134c
Lgc2.23.In1	4888	0x1318	Lin16.In13	4941	0x134d
Lgc2.23.In2	4889	0x1319	Lin16.In14	4942	0x134e
Lgc2.23.Out	4890	0x131a	Lin16.InHighLimit	4943	0x134f
Lgc2.24.In1	4891	0x131b	Lin16.InLowLimit	4928	0x1340
Lgc2.24.In2	4892	0x131c	Lin16.Out	4961	0x1361
Lgc2.24.Out	4893	0x131d	Lin16.Out1	4945	0x1351
Lgc8.1.In1	4894	0x131e	Lin16.Out2	4946	0x1352
Lgc8.1.In2	4895	0x131f	Lin16.Out3	4947	0x1353
Lgc8.1.In3	4896	0x1320	Lin16.Out4	4948	0x1354
Lgc8.1.In4	4897	0x1321	Lin16.Out5	4949	0x1355
Lgc8.1.In5	4898	0x1322	Lin16.Out6	4950	0x1356
Lgc8.1.In6	4899	0x1323	Lin16.Out7	4951	0x1357
Lgc8.1.In7	4900	0x1324	Lin16.Out8	4952	0x1358
Lgc8.1.In8	4901	0x1325	Lin16.Out9	4953	0x1359
Lgc8.1.Out	4902	0x1326	Lin16.Out10	4954	0x135a
Lgc8.2.In1	4903	0x1327	Lin16.Out11	4955	0x135b
Lgc8.2.In2	4904	0x1328	Lin16.Out12	4956	0x135c
Lgc8.2.In3	4905	0x1329	Lin16.Out13	4957	0x135d
Lgc8.2.In4	4906	0x132a	Lin16.Out14	4958	0x135e
Lgc8.2.In5	4907	0x132b	Lin16.OutHighLimit	4959	0x135f
Lgc8.2.In6	4908	0x132c	Lin16.OutLowLimit	4944	0x1350
Lgc8.2.In7	4909	0x132d	Loop.1.Diag.DerivativeOutContrib	119	0x0077
Lgc8.2.In8	4910	0x132e	Loop.1.Diag.Error	113	0x0071
Lgc8.2.Out	4911	0x132f	Loop.1.Diag.IntegralOutContrib	118	0x0076
Lgc8.3.In1	5054	0x13be	Loop.1.Diag.LoopBreakAlarm	116	0x0074
Lgc8.3.In2	5055	0x13bf	Loop.1.Diag.LoopMode	114	0x0072
Lgc8.3.In3	5056	0x13c0	Loop.1.Diag.PropOutContrib	117	0x0075
Lgc8.3.In4	5057	0x13c1	Loop.1.Diag.SBrk	120	0x0078
Lgc8.3.In5	5058	0x13c2	Loop.1.Diag.SchedCBH	32	0x0020
Lgc8.3.In6	5059	0x13c3	Loop.1.Diag.SchedCBL	33	0x0021
Lgc8.3.In7	5060	0x13c4	Loop.1.Diag.SchedLPBrk	35	0x0023
Lgc8.3.In8	5061	0x13c5	Loop.1.Diag.SchedMR	34	0x0022
Lgc8.3.Out	5062	0x13c6	Loop.1.Diag.SchedOPHi	37	0x0025
Lgc8.4.In1	5063	0x13c7	Loop.1.Diag.SchedOPLo	38	0x0026
Lgc8.4.In2	5064	0x13c8	Loop.1.Diag.SchedPB	29	0x001d
Lgc8.4.In3	5065	0x13c9	Loop.1.Diag.SchedR2G	36	0x0024
Lgc8.4.In4	5066	0x13ca	Loop.1.Diag.SchedTd	31	0x001f
Lgc8.4.In5	5067	0x13cb	Loop.1.Diag.SchedTi	30	0x001e
Lgc8.4.In6	5068	0x13cc	Loop.1.Diag.TargetOutVal	115	0x0073
Lgc8.4.In7	5069	0x13cd	Loop.1.Main.ActiveOut	4	0x0004
Lgc8.4.In8	5070	0x13ce	Loop.1.Main.AutoMan	10	0x000a
Lgc8.4.Out	5071	0x13cf	Loop.1.Main.Inhibit	20	0x0014
Lin16.In	4960	0x1360	Loop.1.Main.PV	1	0x0001
Lin16.In1	4929	0x1341	Loop.1.Main.TargetSP	2	0x0002
Lin16.In2	4930	0x1342	Loop.1.Main.WorkingSP	5	0x0005

MINI8 CONTROLLER: ENGINEERING HANDBOOK

Parameter Description / Modbus address	DEC	HEX	Parameter Description / Modbus address	DEC	HEX
Loop.1.OP.Ch1OnOffHysteresis	84	0x0054	Loop.1.PID.ProportionalBand2	43	0x002b
Loop.1.OP.Ch1Out	82	0x0052	Loop.1.PID.ProportionalBand3	53	0x0035
Loop.1.OP.Ch2Deadband	16	0x0010	Loop.1.PID.RelCh2Gain	19	0x0013
Loop.1.OP.Ch2OnOffHysteresis	85	0x0055	Loop.1.PID.RelCh2Gain2	50	0x0032
Loop.1.OP.Ch2Out	83	0x0053	Loop.1.PID.RelCh2Gain3	60	0x003c
Loop.1.OP.CoolType	93	0x005d	Loop.1.PID.SchedulerRemoteInput	65	0x0041
Loop.1.OP.EnablePowerFeedforward	91	0x005b	Loop.1.PID.SchedulerType	63	0x003f
Loop.1.OP.FeedForwardGain	95	0x005f	Loop.1.Setup.CH1ControlType	22	0x0016
Loop.1.OP.FeedForwardOffset	96	0x0060	Loop.1.Setup.CH2ControlType	23	0x0017
Loop.1.OP.FeedForwardTrimLimit	97	0x0061	Loop.1.Setup.ControlAction	7	0x0007
Loop.1.OP.FeedForwardType	94	0x005e	Loop.1.Setup.DerivativeType	25	0x0019
Loop.1.OP.FeedForwardVal	98	0x0062	Loop.1.Setup.LoopType	21	0x0015
Loop.1.OP.FF_Rem	103	0x0067	Loop.1.Setup.PBUnits	24	0x0018
Loop.1.OP.ManualMode	90	0x005a	Loop.1.SP.AltSP	68	0x0044
Loop.1.OP.ManualOutVal	3	0x0003	Loop.1.SP.AltSPSelect	69	0x0045
Loop.1.OP.MeasuredPower	92	0x005c	Loop.1.SP.ManualTrack	75	0x004b
Loop.1.OP.OutputHighLimit	80	0x0050	Loop.1.SP.RangeHigh	12	0x000c
Loop.1.OP.OutputLowLimit	81	0x0051	Loop.1.SP.RangeLow	11	0x000b
Loop.1.OP.Rate	86	0x0056	Loop.1.SP.Rate	70	0x0046
Loop.1.OP.RateDisable	87	0x0057	Loop.1.SP.RateDisable	71	0x0047
Loop.1.OP.RemOPH	102	0x0066	Loop.1.SP.RateDone	79	0x004f
Loop.1.OP.RemOPL	101	0x0065	Loop.1.SP.SP1	13	0x000d
Loop.1.OP.SafeOutVal	89	0x0059	Loop.1.SP.SP2	14	0x000e
Loop.1.OP.SBrkOP	123	0x007B	Loop.1.SP.SPHighLimit	66	0x0042
Loop.1.OP.SensorBreakMode	88	0x0058	Loop.1.SP.SPLowLimit	67	0x0043
Loop.1.OP.TrackEnable	100	0x0064	Loop.1.SP.SPSelect	15	0x000f
Loop.1.OP.TrackOutVal	99	0x0063	Loop.1.SP.SPTrack	76	0x004c
Loop.1.PID.ActiveSet	28	0x001c	Loop.1.SP.SPTrim	72	0x0048
Loop.1.PID.Boundary1-2	26	0x001a	Loop.1.SP.SPTrimHighLimit	73	0x0049
Loop.1.PID.Boundary2-3	27	0x001b	Loop.1.SP.SPTrimLowLimit	74	0x004a
Loop.1.PID.CutbackHigh	18	0x0012	Loop.1.SP.TrackPV	77	0x004d
Loop.1.PID.CutbackHigh2	46	0x002e	Loop.1.SP.TrackSP	78	0x004e
Loop.1.PID.CutbackHigh3	56	0x0038	Loop.1.Tune.AutotuneEnable	108	0x006c
Loop.1.PID.CutbackLow	17	0x0011	Loop.1.Tune.OutputHighLimit	105	0x0069
Loop.1.PID.CutbackLow2	47	0x002f	Loop.1.Tune.OutputLowLimit	106	0x006a
Loop.1.PID.CutbackLow3	57	0x0039	Loop.1.Tune.Stage	111	0x006f
Loop.1.PID.DerivativeTime	9	0x0009	Loop.1.Tune.StageTime	112	0x0070
Loop.1.PID.DerivativeTime2	45	0x002d	Loop.1.Tune.State	110	0x006e
Loop.1.PID.DerivativeTime3	55	0x0037	Loop.1.Tune.StepSize	109	0x006d
Loop.1.PID.IntegralTime	8	0x0008	Loop.1.Tune.Type	104	0x0068
Loop.1.PID.IntegralTime2	44	0x002c	Loop.2.Diag.DerivativeOutContrib	375	0x0177
Loop.1.PID.IntegralTime3	54	0x0036	Loop.2.Diag.Error	369	0x0171
Loop.1.PID.LoopBreakTime	40	0x0028	Loop.2.Diag.IntegralOutContrib	374	0x0176
Loop.1.PID.LoopBreakTime2	49	0x0031	Loop.2.Diag.LoopBreakAlarm	372	0x0174
Loop.1.PID.LoopBreakTime3	59	0x003b	Loop.2.Diag.LoopMode	370	0x0172
Loop.1.PID.ManualReset	39	0x0027	Loop.2.Diag.PropOutContrib	373	0x0175
Loop.1.PID.ManualReset2	48	0x0030	Loop.2.Diag.SBrk	376	0x0178
Loop.1.PID.ManualReset3	58	0x003a	Loop.2.Diag.SchedCBH	288	0x0120
Loop.1.PID.NumSets	64	0x0040	Loop.2.Diag.SchedCBL	289	0x0121
Loop.1.PID.OutputHi	41	0x0029	Loop.2.Diag.SchedLPBrk	291	0x0123
Loop.1.PID.OutputHi2	51	0x0033	Loop.2.Diag.SchedMR	290	0x0122
Loop.1.PID.OutputHi3	61	0x003d	Loop.2.Diag.SchedOPHi	293	0x0125
Loop.1.PID.OutputLo	42	0x002a	Loop.2.Diag.SchedOPLo	294	0x0126
Loop.1.PID.OutputLo2	52	0x0034	Loop.2.Diag.SchedPB	285	0x011d
Loop.1.PID.OutputLo3	62	0x003e	Loop.2.Diag.SchedR2G	292	0x0124
Loop.1.PID.ProportionalBand	6	0x0006	Loop.2.Diag.SchedTd	287	0x011f

MINI8 CONTROLLER: ENGINEERING HANDBOOK

Parameter Description / Modbus address	DEC	HEX	Parameter Description / Modbus address	DEC	HEX
Loop.2.Diag.SchedTi	286	0x011e	Loop.2.PID.ManualReset3	314	0x013a
Loop.2.Diag.TargetOutVal	371	0x0173	Loop.2.PID.NumSets	320	0x0140
Loop.2.Main.ActiveOut	260	0x0104	Loop.2.PID.OutputHi	297	0x0129
Loop.2.Main.AutoMan	266	0x010a	Loop.2.PID.OutputHi2	307	0x0133
Loop.2.Main.Inhibit	276	0x0114	Loop.2.PID.OutputHi3	317	0x013d
Loop.2.Main.PV	257	0x0101	Loop.2.PID.OutputLo	298	0x012a
Loop.2.Main.TargetSP	258	0x0102	Loop.2.PID.OutputLo2	308	0x0134
Loop.2.Main.WorkingSP	261	0x0105	Loop.2.PID.OutputLo3	318	0x013e
Loop.2.OP.Ch1OnOffHysteresis	340	0x0154	Loop.2.PID.ProportionalBand	262	0x0106
Loop.2.OP.Ch1Out	338	0x0152	Loop.2.PID.ProportionalBand2	299	0x012b
Loop.2.OP.Ch2Deadband	272	0x0110	Loop.2.PID.ProportionalBand3	309	0x0135
Loop.2.OP.Ch2OnOffHysteresis	341	0x0155	Loop.2.PID.RelCh2Gain	275	0x0113
Loop.2.OP.Ch2Out	339	0x0153	Loop.2.PID.RelCh2Gain2	306	0x0132
Loop.2.OP.CoolType	349	0x015d	Loop.2.PID.RelCh2Gain3	316	0x013c
Loop.2.OP.EnablePowerFeedforward	347	0x015b	Loop.2.PID.SchedulerRemoteInput	321	0x0141
Loop.2.OP.FeedForwardGain	351	0x015f	Loop.2.PID.SchedulerType	319	0x013f
Loop.2.OP.FeedForwardOffset	352	0x0160	Loop.2.Setup.CH1ControlType	278	0x0116
Loop.2.OP.FeedForwardTrimLimit	353	0x0161	Loop.2.Setup.CH2ControlType	279	0x0117
Loop.2.OP.FeedForwardType	350	0x015e	Loop.2.Setup.ControlAction	263	0x0107
Loop.2.OP.FeedForwardVal	354	0x0162	Loop.2.Setup.DerivativeType	281	0x0119
Loop.2.OP.FF_Rem	359	0x0167	Loop.2.Setup.LoopType	277	0x0115
Loop.2.OP.ManualMode	346	0x015a	Loop.2.Setup.PBUnits	280	0x0118
Loop.2.OP.ManualOutVal	259	0x0103	Loop.2.SP.AltSP	324	0x0144
Loop.2.OP.MeasuredPower	348	0x015c	Loop.2.SP.AltSPSelect	325	0x0145
Loop.2.OP.OutputHighLimit	336	0x0150	Loop.2.SP.ManualTrack	331	0x014b
Loop.2.OP.OutputLowLimit	337	0x0151	Loop.2.SP.RangeHigh	268	0x010c
Loop.2.OP.Rate	342	0x0156	Loop.2.SP.RangeLow	267	0x010b
Loop.2.OP.RateDisable	343	0x0157	Loop.2.SP.Rate	326	0x0146
Loop.2.OP.RemOPH	358	0x0166	Loop.2.SP.RateDisable	327	0x0147
Loop.2.OP.RemOPL	357	0x0165	Loop.2.SP.RateDone	335	0x014f
Loop.2.OP.SafeOutVal	345	0x0159	Loop.2.SP.SP1	269	0x010d
Loop.2.OP.SBrkOP	379	0x017B	Loop.2.SP.SP2	270	0x010e
Loop.2.OP.SensorBreakMode	344	0x0158	Loop.2.SP.SPHighLimit	322	0x0142
Loop.2.OP.TrackEnable	356	0x0164	Loop.2.SP.SPLowLimit	323	0x0143
Loop.2.OP.TrackOutVal	355	0x0163	Loop.2.SP.SPSelect	271	0x010f
Loop.2.PID.ActiveSet	284	0x011c	Loop.2.SP.SPTrack	332	0x014c
Loop.2.PID.Boundary1-2	282	0x011a	Loop.2.SP.SPTrim	328	0x0148
Loop.2.PID.Boundary2-3	283	0x011b	Loop.2.SP.SPTrimHighLimit	329	0x0149
Loop.2.PID.CutbackHigh	274	0x0112	Loop.2.SP.SPTrimLowLimit	330	0x014a
Loop.2.PID.CutbackHigh2	302	0x012e	Loop.2.SP.TrackPV	333	0x014d
Loop.2.PID.CutbackHigh3	312	0x0138	Loop.2.SP.TrackSP	334	0x014e
Loop.2.PID.CutbackLow	273	0x0111	Loop.2.Tune.AutotuneEnable	364	0x016c
Loop.2.PID.CutbackLow2	303	0x012f	Loop.2.Tune.OutputHighLimit	361	0x0169
Loop.2.PID.CutbackLow3	313	0x0139	Loop.2.Tune.OutputLowLimit	362	0x016a
Loop.2.PID.DerivativeTime	265	0x0109	Loop.2.Tune.Stage	367	0x016f
Loop.2.PID.DerivativeTime2	301	0x012d	Loop.2.Tune.StageTime	368	0x0170
Loop.2.PID.DerivativeTime3	311	0x0137	Loop.2.Tune.State	366	0x016e
Loop.2.PID.IntegralTime	264	0x0108	Loop.2.Tune.StepSize	365	0x016d
Loop.2.PID.IntegralTime2	300	0x012c	Loop.2.Tune.Type	360	0x0168
Loop.2.PID.IntegralTime3	310	0x0136	Loop.3.Diag.DerivativeOutContrib	631	0x0277
Loop.2.PID.LoopBreakTime	296	0x0128	Loop.3.Diag.Error	625	0x0271
Loop.2.PID.LoopBreakTime2	305	0x0131	Loop.3.Diag.IntegralOutContrib	630	0x0276
Loop.2.PID.LoopBreakTime3	315	0x013b	Loop.3.Diag.LoopBreakAlarm	628	0x0274
Loop.2.PID.ManualReset	295	0x0127	Loop.3.Diag.LoopMode	626	0x0272
Loop.2.PID.ManualReset2	304	0x0130	Loop.3.Diag.PropOutContrib	629	0x0275

MINI8 CONTROLLER: ENGINEERING HANDBOOK

Parameter Description / Modbus address	DEC	HEX	Parameter Description / Modbus address	DEC	HEX
Loop.3.Diag.SBrk	632	0x0278	Loop.3.PID.DerivativeTime3	567	0x0237
Loop.3.Diag.SchedCBH	544	0x0220	Loop.3.PID.IntegralTime	520	0x0208
Loop.3.Diag.SchedCBL	545	0x0221	Loop.3.PID.IntegralTime2	556	0x022c
Loop.3.Diag.SchedLPBrk	547	0x0223	Loop.3.PID.IntegralTime3	566	0x0236
Loop.3.Diag.SchedMR	546	0x0222	Loop.3.PID.LoopBreakTime	552	0x0228
Loop.3.Diag.SchedOPHi	549	0x0225	Loop.3.PID.LoopBreakTime2	561	0x0231
Loop.3.Diag.SchedOPLo	550	0x0226	Loop.3.PID.LoopBreakTime3	571	0x023b
Loop.3.Diag.SchedPB	541	0x021d	Loop.3.PID.ManualReset	551	0x0227
Loop.3.Diag.SchedR2G	548	0x0224	Loop.3.PID.ManualReset2	560	0x0230
Loop.3.Diag.SchedTd	543	0x021f	Loop.3.PID.ManualReset3	570	0x023a
Loop.3.Diag.SchedTi	542	0x021e	Loop.3.PID.NumSets	576	0x0240
Loop.3.Diag.TargetOutVal	627	0x0273	Loop.3.PID.OutputHi	553	0x0229
Loop.3.Main.ActiveOut	516	0x0204	Loop.3.PID.OutputHi2	563	0x0233
Loop.3.Main.AutoMan	522	0x020a	Loop.3.PID.OutputHi3	573	0x023d
Loop.3.Main.Inhibit	532	0x0214	Loop.3.PID.OutputLo	554	0x022a
Loop.3.Main.PV	513	0x0201	Loop.3.PID.OutputLo2	564	0x0234
Loop.3.Main.TargetSP	514	0x0202	Loop.3.PID.OutputLo3	574	0x023e
Loop.3.Main.WorkingSP	517	0x0205	Loop.3.PID.ProportionalBand	518	0x0206
Loop.3.OP.Ch1OnOffHysteresis	596	0x0254	Loop.3.PID.ProportionalBand2	555	0x022b
Loop.3.OP.Ch1Out	594	0x0252	Loop.3.PID.ProportionalBand3	565	0x0235
Loop.3.OP.Ch2Deadband	528	0x0210	Loop.3.PID.RelCh2Gain	531	0x0213
Loop.3.OP.Ch2OnOffHysteresis	597	0x0255	Loop.3.PID.RelCh2Gain2	562	0x0232
Loop.3.OP.Ch2Out	595	0x0253	Loop.3.PID.RelCh2Gain3	572	0x023c
Loop.3.OP.CoolType	605	0x025d	Loop.3.PID.SchedulerRemoteInput	577	0x0241
Loop.3.OP.EnablePowerFeedforward	603	0x025b	Loop.3.PID.SchedulerType	575	0x023f
Loop.3.OP.FeedForwardGain	607	0x025f	Loop.3.Setup.CH1ControlType	534	0x0216
Loop.3.OP.FeedForwardOffset	608	0x0260	Loop.3.Setup.CH2ControlType	535	0x0217
Loop.3.OP.FeedForwardTrimLimit	609	0x0261	Loop.3.Setup.ControlAction	519	0x0207
Loop.3.OP.FeedForwardType	606	0x025e	Loop.3.Setup.DerivativeType	537	0x0219
Loop.3.OP.FeedForwardVal	610	0x0262	Loop.3.Setup.LoopType	533	0x0215
Loop.3.OP.FF_Rem	615	0x0267	Loop.3.Setup.PBUnits	536	0x0218
Loop.3.OP.ManualMode	602	0x025a	Loop.3.SP.AltSP	580	0x0244
Loop.3.OP.ManualOutVal	515	0x0203	Loop.3.SP.AltSPSelect	581	0x0245
Loop.3.OP.MeasuredPower	604	0x025c	Loop.3.SP.ManualTrack	587	0x024b
Loop.3.OP.OutputHighLimit	592	0x0250	Loop.3.SP.RangeHigh	524	0x020c
Loop.3.OP.OutputLowLimit	593	0x0251	Loop.3.SP.RangeLow	523	0x020b
Loop.3.OP.Rate	598	0x0256	Loop.3.SP.Rate	582	0x0246
Loop.3.OP.RateDisable	599	0x0257	Loop.3.SP.RateDisable	583	0x0247
Loop.3.OP.RemOPH	614	0x0266	Loop.3.SP.RateDone	591	0x024f
Loop.3.OP.RemOPL	613	0x0265	Loop.3.SP.SP1	525	0x020d
Loop.3.OP.SafeOutVal	601	0x0259	Loop.3.SP.SP2	526	0x020e
Loop.3.OP.SBrkOP	635	0x027B	Loop.3.SP.SPHighLimit	578	0x0242
Loop.3.OP.SensorBreakMode	600	0x0258	Loop.3.SP.SPLowLimit	579	0x0243
Loop.3.OP.TrackEnable	612	0x0264	Loop.3.SP.SPSelect	527	0x020f
Loop.3.OP.TrackOutVal	611	0x0263	Loop.3.SP.SPTrack	588	0x024c
Loop.3.PID.ActiveSet	540	0x021c	Loop.3.SP.SPTrim	584	0x0248
Loop.3.PID.Boundary1-2	538	0x021a	Loop.3.SP.SPTrimHighLimit	585	0x0249
Loop.3.PID.Boundary2-3	539	0x021b	Loop.3.SP.SPTrimLowLimit	586	0x024a
Loop.3.PID.CutbackHigh	530	0x0212	Loop.3.SP.TrackPV	589	0x024d
Loop.3.PID.CutbackHigh2	558	0x022e	Loop.3.SP.TrackSP	590	0x024e
Loop.3.PID.CutbackHigh3	568	0x0238	Loop.3.Tune.AutotuneEnable	620	0x026c
Loop.3.PID.CutbackLow	529	0x0211	Loop.3.Tune.OutputHighLimit	617	0x0269
Loop.3.PID.CutbackLow2	559	0x022f	Loop.3.Tune.OutputLowLimit	618	0x026a
Loop.3.PID.CutbackLow3	569	0x0239	Loop.3.Tune.Stage	623	0x026f
Loop.3.PID.DerivativeTime	521	0x0209	Loop.3.Tune.StageTime	624	0x0270
Loop.3.PID.DerivativeTime2	557	0x022d	Loop.3.Tune.State	622	0x026e

MINI8 CONTROLLER: ENGINEERING HANDBOOK

Parameter Description / Modbus address	DEC	HEX
Loop.3.Tune.StepSize	621	0x026d
Loop.3.Tune.Type	616	0x0268
Loop.4.Diag.DerivativeOutContrib	887	0x0377
Loop.4.Diag.Error	881	0x0371
Loop.4.Diag.IntegralOutContrib	886	0x0376
Loop.4.Diag.LoopBreakAlarm	884	0x0374
Loop.4.Diag.LoopMode	882	0x0372
Loop.4.Diag.PropOutContrib	885	0x0375
Loop.4.Diag.SBrk	888	0x0378
Loop.4.Diag.SchedCBH	800	0x0320
Loop.4.Diag.SchedCBL	801	0x0321
Loop.4.Diag.SchedLPBrk	803	0x0323
Loop.4.Diag.SchedMR	802	0x0322
Loop.4.Diag.SchedOPHi	805	0x0325
Loop.4.Diag.SchedOPLo	806	0x0326
Loop.4.Diag.SchedPB	797	0x031d
Loop.4.Diag.SchedR2G	804	0x0324
Loop.4.Diag.SchedTd	799	0x031f
Loop.4.Diag.SchedTi	798	0x031e
Loop.4.Diag.TargetOutVal	883	0x0373
Loop.4.Main.ActiveOut	772	0x0304
Loop.4.Main.AutoMan	778	0x030a
Loop.4.Main.Inhibit	788	0x0314
Loop.4.Main.PV	769	0x0301
Loop.4.Main.TargetSP	770	0x0302
Loop.4.Main.WorkingSP	773	0x0305
Loop.4.OP.Ch1OnOffHysteresis	852	0x0354
Loop.4.OP.Ch1Out	850	0x0352
Loop.4.OP.Ch2Deadband	784	0x0310
Loop.4.OP.Ch2OnOffHysteresis	853	0x0355
Loop.4.OP.Ch2Out	851	0x0353
Loop.4.OP.CoolType	861	0x035d
Loop.4.OP.EnablePowerFeedforward	859	0x035b
Loop.4.OP.FeedForwardGain	863	0x035f
Loop.4.OP.FeedForwardOffset	864	0x0360
Loop.4.OP.FeedForwardTrimLimit	865	0x0361
Loop.4.OP.FeedForwardType	862	0x035e
Loop.4.OP.FeedForwardVal	866	0x0362
Loop.4.OP.FF_Rem	871	0x0367
Loop.4.OP.ManualMode	858	0x035a
Loop.4.OP.ManualOutVal	771	0x0303
Loop.4.OP.MeasuredPower	860	0x035c
Loop.4.OP.OutputHighLimit	848	0x0350
Loop.4.OP.OutputLowLimit	849	0x0351
Loop.4.OP.Rate	854	0x0356
Loop.4.OP.RateDisable	855	0x0357
Loop.4.OP.RemOPH	870	0x0366
Loop.4.OP.RemOPL	869	0x0365
Loop.4.OP.SafeOutVal	857	0x0359
Loop.4.OP.SBrkOP	891	0x037B
Loop.4.OP.SensorBreakMode	856	0x0358
Loop.4.OP.TrackEnable	868	0x0364
Loop.4.OP.TrackOutVal	867	0x0363
Loop.4.PID.ActiveSet	796	0x031c
Loop.4.PID.Boundary1-2	794	0x031a

Parameter Description / Modbus address	DEC	HEX
Loop.4.PID.Boundary2-3	795	0x031b
Loop.4.PID.CutbackHigh	786	0x0312
Loop.4.PID.CutbackHigh2	814	0x032e
Loop.4.PID.CutbackHigh3	824	0x0338
Loop.4.PID.CutbackLow	785	0x0311
Loop.4.PID.CutbackLow2	815	0x032f
Loop.4.PID.CutbackLow3	825	0x0339
Loop.4.PID.DerivativeTime	777	0x0309
Loop.4.PID.DerivativeTime2	813	0x032d
Loop.4.PID.DerivativeTime3	823	0x0337
Loop.4.PID.IntegralTime	776	0x0308
Loop.4.PID.IntegralTime2	812	0x032c
Loop.4.PID.IntegralTime3	822	0x0336
Loop.4.PID.LoopBreakTime	808	0x0328
Loop.4.PID.LoopBreakTime2	817	0x0331
Loop.4.PID.LoopBreakTime3	827	0x033b
Loop.4.PID.ManualReset	807	0x0327
Loop.4.PID.ManualReset2	816	0x0330
Loop.4.PID.ManualReset3	826	0x033a
Loop.4.PID.NumSets	832	0x0340
Loop.4.PID.OutputHi	809	0x0329
Loop.4.PID.OutputHi2	819	0x0333
Loop.4.PID.OutputHi3	829	0x033d
Loop.4.PID.OutputLo	810	0x032a
Loop.4.PID.OutputLo2	820	0x0334
Loop.4.PID.OutputLo3	830	0x033e
Loop.4.PID.ProportionalBand	774	0x0306
Loop.4.PID.ProportionalBand2	811	0x032b
Loop.4.PID.ProportionalBand3	821	0x0335
Loop.4.PID.RelCh2Gain	787	0x0313
Loop.4.PID.RelCh2Gain2	818	0x0332
Loop.4.PID.RelCh2Gain3	828	0x033c
Loop.4.PID.SchedulerRemoteInput	833	0x0341
Loop.4.PID.SchedulerType	831	0x033f
Loop.4.Setup.CH1ControlType	790	0x0316
Loop.4.Setup.CH2ControlType	791	0x0317
Loop.4.Setup.ControlAction	775	0x0307
Loop.4.Setup.DerivativeType	793	0x0319
Loop.4.Setup.LoopType	789	0x0315
Loop.4.Setup.PBUnits	792	0x0318
Loop.4.SP.AltSP	836	0x0344
Loop.4.SP.AltSPSelect	837	0x0345
Loop.4.SP.ManualTrack	843	0x034b
Loop.4.SP.RangeHigh	780	0x030c
Loop.4.SP.RangeLow	779	0x030b
Loop.4.SP.Rate	838	0x0346
Loop.4.SP.RateDisable	839	0x0347
Loop.4.SP.RateDone	847	0x034f
Loop.4.SP.SP1	781	0x030d
Loop.4.SP.SP2	782	0x030e
Loop.4.SP.SPHighLimit	834	0x0342
Loop.4.SP.SPLowLimit	835	0x0343
Loop.4.SP.SPSelect	783	0x030f
Loop.4.SP.SPTrack	844	0x034c
Loop.4.SP.SPTrim	840	0x0348

MINI8 CONTROLLER: ENGINEERING HANDBOOK

Parameter Description / Modbus address	DEC	HEX	Parameter Description / Modbus address	DEC	HEX
Loop.4.SP.SPTTrimHighLimit	841	0x0349	Loop.5.OP.RemOPH	1126	0x0466
Loop.4.SP.SPTTrimLowLimit	842	0x034a	Loop.5.OP.RemOPL	1125	0x0465
Loop.4.SP.TrackPV	845	0x034d	Loop.5.OP.SafeOutVal	1113	0x0459
Loop.4.SP.TrackSP	846	0x034e	Loop.5.OP.SBrkOP	1147	0x047B
Loop.4.Tune.AutotuneEnable	876	0x036c	Loop.5.OP.SensorBreakMode	1112	0x0458
Loop.4.Tune.OutputHighLimit	873	0x0369	Loop.5.OP.TrackEnable	1124	0x0464
Loop.4.Tune.OutputLowLimit	874	0x036a	Loop.5.OP.TrackOutVal	1123	0x0463
Loop.4.Tune.Stage	879	0x036f	Loop.5.PID.ActiveSet	1052	0x041c
Loop.4.Tune.StageTime	880	0x0370	Loop.5.PID.Boundary1-2	1050	0x041a
Loop.4.Tune.State	878	0x036e	Loop.5.PID.Boundary2-3	1051	0x041b
Loop.4.Tune.StepSize	877	0x036d	Loop.5.PID.CutbackHigh	1042	0x0412
Loop.4.Tune.Type	872	0x0368	Loop.5.PID.CutbackHigh2	1070	0x042e
Loop.5.Diag.DerivativeOutContrib	1143	0x0477	Loop.5.PID.CutbackHigh3	1080	0x0438
Loop.5.Diag.Error	1137	0x0471	Loop.5.PID.CutbackLow	1041	0x0411
Loop.5.Diag.IntegralOutContrib	1142	0x0476	Loop.5.PID.CutbackLow2	1071	0x042f
Loop.5.Diag.LoopBreakAlarm	1140	0x0474	Loop.5.PID.CutbackLow3	1081	0x0439
Loop.5.Diag.LoopMode	1138	0x0472	Loop.5.PID.DerivativeTime	1033	0x0409
Loop.5.Diag.PropOutContrib	1141	0x0475	Loop.5.PID.DerivativeTime2	1069	0x042d
Loop.5.Diag.SBrk	1144	0x0478	Loop.5.PID.DerivativeTime3	1079	0x0437
Loop.5.Diag.SchedCBH	1056	0x0420	Loop.5.PID.IntegralTime	1032	0x0408
Loop.5.Diag.SchedCBL	1057	0x0421	Loop.5.PID.IntegralTime2	1068	0x042c
Loop.5.Diag.SchedLPBrk	1059	0x0423	Loop.5.PID.IntegralTime3	1078	0x0436
Loop.5.Diag.SchedMR	1058	0x0422	Loop.5.PID.LoopBreakTime	1064	0x0428
Loop.5.Diag.SchedOPHi	1061	0x0425	Loop.5.PID.LoopBreakTime2	1073	0x0431
Loop.5.Diag.SchedOPLo	1062	0x0426	Loop.5.PID.LoopBreakTime3	1083	0x043b
Loop.5.Diag.SchedPB	1053	0x041d	Loop.5.PID.ManualReset	1063	0x0427
Loop.5.Diag.SchedR2G	1060	0x0424	Loop.5.PID.ManualReset2	1072	0x0430
Loop.5.Diag.SchedTd	1055	0x041f	Loop.5.PID.ManualReset3	1082	0x043a
Loop.5.Diag.SchedTi	1054	0x041e	Loop.5.PID.NumSets	1088	0x0440
Loop.5.Diag.TargetOutVal	1139	0x0473	Loop.5.PID.OutputHi	1065	0x0429
Loop.5.Main.ActiveOut	1028	0x0404	Loop.5.PID.OutputHi2	1075	0x0433
Loop.5.Main.AutoMan	1034	0x040a	Loop.5.PID.OutputHi3	1085	0x043d
Loop.5.Main.Inhibit	1044	0x0414	Loop.5.PID.OutputLo	1066	0x042a
Loop.5.Main.PV	1025	0x0401	Loop.5.PID.OutputLo2	1076	0x0434
Loop.5.Main.TargetSP	1026	0x0402	Loop.5.PID.OutputLo3	1086	0x043e
Loop.5.Main.WorkingSP	1029	0x0405	Loop.5.PID.ProportionalBand	1030	0x0406
Loop.5.OP.Ch1OnOffHysteresis	1108	0x0454	Loop.5.PID.ProportionalBand2	1067	0x042b
Loop.5.OP.Ch1Out	1106	0x0452	Loop.5.PID.ProportionalBand3	1077	0x0435
Loop.5.OP.Ch2Deadband	1040	0x0410	Loop.5.PID.RelCh2Gain	1043	0x0413
Loop.5.OP.Ch2OnOffHysteresis	1109	0x0455	Loop.5.PID.RelCh2Gain2	1074	0x0432
Loop.5.OP.Ch2Out	1107	0x0453	Loop.5.PID.RelCh2Gain3	1084	0x043c
Loop.5.OP.CoolType	1117	0x045d	Loop.5.PID.SchedulerRemotelInput	1089	0x0441
Loop.5.OP.EnablePowerFeedforward	1115	0x045b	Loop.5.PID.SchedulerType	1087	0x043f
Loop.5.OP.FeedForwardGain	1119	0x045f	Loop.5.Setup.CH1ControlType	1046	0x0416
Loop.5.OP.FeedForwardOffset	1120	0x0460	Loop.5.Setup.CH2ControlType	1047	0x0417
Loop.5.OP.FeedForwardTrimLimit	1121	0x0461	Loop.5.Setup.ControlAction	1031	0x0407
Loop.5.OP.FeedForwardType	1118	0x045e	Loop.5.Setup.DerivativeType	1049	0x0419
Loop.5.OP.FeedForwardVal	1122	0x0462	Loop.5.Setup.LoopType	1045	0x0415
Loop.5.OP.FF_Rem	1127	0x0467	Loop.5.Setup.PBUnits	1048	0x0418
Loop.5.OP.ManualMode	1114	0x045a	Loop.5.SP.AltSP	1092	0x0444
Loop.5.OP.ManualOutVal	1027	0x0403	Loop.5.SP.AltSPSelect	1093	0x0445
Loop.5.OP.MeasuredPower	1116	0x045c	Loop.5.SP.ManualTrack	1099	0x044b
Loop.5.OP.OutputHighLimit	1104	0x0450	Loop.5.SP.RangeHigh	1036	0x040c
Loop.5.OP.OutputLowLimit	1105	0x0451	Loop.5.SP.RangeLow	1035	0x040b
Loop.5.OP.Rate	1110	0x0456	Loop.5.SP.Rate	1094	0x0446
Loop.5.OP.RateDisable	1111	0x0457	Loop.5.SP.RateDisable	1095	0x0447

MINI8 CONTROLLER: ENGINEERING HANDBOOK

Parameter Description / Modbus address	DEC	HEX	Parameter Description / Modbus address	DEC	HEX
Loop.5.SP.RateDone	1103	0x044f	Loop.6.OP.FeedForwardVal	1378	0x0562
Loop.5.SP.SP1	1037	0x040d	Loop.6.OP.FF_Rem	1383	0x0567
Loop.5.SP.SP2	1038	0x040e	Loop.6.OP.ManualMode	1370	0x055a
Loop.5.SP.SPHighLimit	1090	0x0442	Loop.6.OP.ManualOutVal	1283	0x0503
Loop.5.SP.SPLowLimit	1091	0x0443	Loop.6.OP.MeasuredPower	1372	0x055c
Loop.5.SP.SPSelect	1039	0x040f	Loop.6.OP.OutputHighLimit	1360	0x0550
Loop.5.SP.SPTrack	1100	0x044c	Loop.6.OP.OutputLowLimit	1361	0x0551
Loop.5.SP.SPTrim	1096	0x0448	Loop.6.OP.Rate	1366	0x0556
Loop.5.SP.SPTrimHighLimit	1097	0x0449	Loop.6.OP.RateDisable	1367	0x0557
Loop.5.SP.SPTrimLowLimit	1098	0x044a	Loop.6.OP.RemOPH	1382	0x0566
Loop.5.SP.TrackPV	1101	0x044d	Loop.6.OP.RemOPL	1381	0x0565
Loop.5.SP.TrackSP	1102	0x044e	Loop.6.OP.SafeOutVal	1369	0x0559
Loop.5.Tune.AutotuneEnable	1132	0x046c	Loop.6.OP.SBrkOP	1403	0x057b
Loop.5.Tune.OutputHighLimit	1129	0x0469	Loop.6.OP.SensorBreakMode	1368	0x0558
Loop.5.Tune.OutputLowLimit	1130	0x046a	Loop.6.OP.TrackEnable	1380	0x0564
Loop.5.Tune.Stage	1135	0x046f	Loop.6.OP.TrackOutVal	1379	0x0563
Loop.5.Tune.StageTime	1136	0x0470	Loop.6.PID.ActiveSet	1308	0x051c
Loop.5.Tune.State	1134	0x046e	Loop.6.PID.Boundary1-2	1306	0x051a
Loop.5.Tune.StepSize	1133	0x046d	Loop.6.PID.Boundary2-3	1307	0x051b
Loop.5.Tune.Type	1128	0x0468	Loop.6.PID.CutbackHigh	1298	0x0512
Loop.6.Diag.DerivativeOutContrib	1399	0x0577	Loop.6.PID.CutbackHigh2	1326	0x052e
Loop.6.Diag.Error	1393	0x0571	Loop.6.PID.CutbackHigh3	1336	0x0538
Loop.6.Diag.IntegralOutContrib	1398	0x0576	Loop.6.PID.CutbackLow	1297	0x0511
Loop.6.Diag.LoopBreakAlarm	1396	0x0574	Loop.6.PID.CutbackLow2	1327	0x052f
Loop.6.Diag.LoopMode	1394	0x0572	Loop.6.PID.CutbackLow3	1337	0x0539
Loop.6.Diag.PropOutContrib	1397	0x0575	Loop.6.PID.DerivativeTime	1289	0x0509
Loop.6.Diag.SBrk	1400	0x0578	Loop.6.PID.DerivativeTime2	1325	0x052d
Loop.6.Diag.SchedCBH	1312	0x0520	Loop.6.PID.DerivativeTime3	1335	0x0537
Loop.6.Diag.SchedCBL	1313	0x0521	Loop.6.PID.IntegralTime	1288	0x0508
Loop.6.Diag.SchedLPBrk	1315	0x0523	Loop.6.PID.IntegralTime2	1324	0x052c
Loop.6.Diag.SchedMR	1314	0x0522	Loop.6.PID.IntegralTime3	1334	0x0536
Loop.6.Diag.SchedOPHi	1317	0x0525	Loop.6.PID.LoopBreakTime	1320	0x0528
Loop.6.Diag.SchedOPLo	1318	0x0526	Loop.6.PID.LoopBreakTime2	1329	0x0531
Loop.6.Diag.SchedPB	1309	0x051d	Loop.6.PID.LoopBreakTime3	1339	0x053b
Loop.6.Diag.SchedR2G	1316	0x0524	Loop.6.PID.ManualReset	1319	0x0527
Loop.6.Diag.SchedTd	1311	0x051f	Loop.6.PID.ManualReset2	1328	0x0530
Loop.6.Diag.SchedTi	1310	0x051e	Loop.6.PID.ManualReset3	1338	0x053a
Loop.6.Diag.TargetOutVal	1395	0x0573	Loop.6.PID.NumSets	1344	0x0540
Loop.6.Main.ActiveOut	1284	0x0504	Loop.6.PID.OutputHi	1321	0x0529
Loop.6.Main.AutoMan	1290	0x050a	Loop.6.PID.OutputHi2	1331	0x0533
Loop.6.Main.Inhibit	1300	0x0514	Loop.6.PID.OutputHi3	1341	0x053d
Loop.6.Main.PV	1281	0x0501	Loop.6.PID.OutputLo	1322	0x052a
Loop.6.Main.TargetSP	1282	0x0502	Loop.6.PID.OutputLo2	1332	0x0534
Loop.6.Main.WorkingSP	1285	0x0505	Loop.6.PID.OutputLo3	1342	0x053e
Loop.6.OP.Ch1OnOffHysteresis	1364	0x0554	Loop.6.PID.ProportionalBand	1286	0x0506
Loop.6.OP.Ch1Out	1362	0x0552	Loop.6.PID.ProportionalBand2	1323	0x052b
Loop.6.OP.Ch2Deadband	1296	0x0510	Loop.6.PID.ProportionalBand3	1333	0x0535
Loop.6.OP.Ch2OnOffHysteresis	1365	0x0555	Loop.6.PID.RelCh2Gain	1299	0x0513
Loop.6.OP.Ch2Out	1363	0x0553	Loop.6.PID.RelCh2Gain2	1330	0x0532
Loop.6.OP.CoolType	1373	0x055d	Loop.6.PID.RelCh2Gain3	1340	0x053c
Loop.6.OP.EnablePowerFeedforward	1371	0x055b	Loop.6.PID.SchedulerRemoteInput	1345	0x0541
Loop.6.OP.FeedForwardGain	1375	0x055f	Loop.6.PID.SchedulerType	1343	0x053f
Loop.6.OP.FeedForwardOffset	1376	0x0560	Loop.6.Setup.CH1ControlType	1302	0x0516
Loop.6.OP.FeedForwardTrimLimit	1377	0x0561	Loop.6.Setup.CH2ControlType	1303	0x0517
Loop.6.OP.FeedForwardType	1374	0x055e	Loop.6.Setup.ControlAction	1287	0x0507

MINI8 CONTROLLER: ENGINEERING HANDBOOK

Parameter Description / Modbus address	DEC	HEX
Loop.6.Setup.DerivativeType	1305	0x0519
Loop.6.Setup.LoopType	1301	0x0515
Loop.6.Setup.PBUnits	1304	0x0518
Loop.6.SP.AltSP	1348	0x0544
Loop.6.SP.AltSPSelect	1349	0x0545
Loop.6.SP.ManualTrack	1355	0x054b
Loop.6.SP.RangeHigh	1292	0x050c
Loop.6.SP.RangeLow	1291	0x050b
Loop.6.SP.Rate	1350	0x0546
Loop.6.SP.RateDisable	1351	0x0547
Loop.6.SP.RateDone	1359	0x054f
Loop.6.SP.SP1	1293	0x050d
Loop.6.SP.SP2	1294	0x050e
Loop.6.SP.SPHighLimit	1346	0x0542
Loop.6.SP.SPLowLimit	1347	0x0543
Loop.6.SP.SPSelect	1295	0x050f
Loop.6.SP.SPTrack	1356	0x054c
Loop.6.SP.SPTrim	1352	0x0548
Loop.6.SP.SPTrimHighLimit	1353	0x0549
Loop.6.SP.SPTrimLowLimit	1354	0x054a
Loop.6.SP.TrackPV	1357	0x054d
Loop.6.SP.TrackSP	1358	0x054e
Loop.6.Tune.AutotuneEnable	1388	0x056c
Loop.6.Tune.OutputHighLimit	1385	0x0569
Loop.6.Tune.OutputLowLimit	1386	0x056a
Loop.6.Tune.Stage	1391	0x056f
Loop.6.Tune.StageTime	1392	0x0570
Loop.6.Tune.State	1390	0x056e
Loop.6.Tune.StepSize	1389	0x056d
Loop.6.Tune.Type	1384	0x0568
Loop.7.Diag.DerivativeOutContrib	1655	0x0677
Loop.7.Diag.Error	1649	0x0671
Loop.7.Diag.IntegralOutContrib	1654	0x0676
Loop.7.Diag.LoopBreakAlarm	1652	0x0674
Loop.7.Diag.LoopMode	1650	0x0672
Loop.7.Diag.PropOutContrib	1653	0x0675
Loop.7.Diag.SBrk	1656	0x0678
Loop.7.Diag.SchedCBH	1568	0x0620
Loop.7.Diag.SchedCBL	1569	0x0621
Loop.7.Diag.SchedLPBrk	1571	0x0623
Loop.7.Diag.SchedMR	1570	0x0622
Loop.7.Diag.SchedOPHi	1573	0x0625
Loop.7.Diag.SchedOPLo	1574	0x0626
Loop.7.Diag.SchedPB	1565	0x061d
Loop.7.Diag.SchedR2G	1572	0x0624
Loop.7.Diag.SchedTd	1567	0x061f
Loop.7.Diag.SchedTi	1566	0x061e
Loop.7.Diag.TargetOutVal	1651	0x0673
Loop.7.Main.ActiveOut	1540	0x0604
Loop.7.Main.AutoMan	1546	0x060a
Loop.7.Main.Inhibit	1556	0x0614
Loop.7.Main.PV	1537	0x0601
Loop.7.Main.TargetSP	1538	0x0602
Loop.7.Main.WorkingSP	1541	0x0605
Loop.7.OP.Ch1OnOffHysteresis	1620	0x0654
Loop.7.OP.Ch1Out	1618	0x0652

Parameter Description / Modbus address	DEC	HEX
Loop.7.OP.Ch2Deadband	1552	0x0610
Loop.7.OP.Ch2OnOffHysteresis	1621	0x0655
Loop.7.OP.Ch2Out	1619	0x0653
Loop.7.OP.CoolType	1629	0x065d
Loop.7.OP.EnablePowerFeedforward	1627	0x065b
Loop.7.OP.FeedForwardGain	1631	0x065f
Loop.7.OP.FeedForwardOffset	1632	0x0660
Loop.7.OP.FeedForwardTrimLimit	1633	0x0661
Loop.7.OP.FeedForwardType	1630	0x065e
Loop.7.OP.FeedForwardVal	1634	0x0662
Loop.7.OP.FF_Rem	1639	0x0667
Loop.7.OP.ManualMode	1626	0x065a
Loop.7.OP.ManualOutVal	1539	0x0603
Loop.7.OP.MeasuredPower	1628	0x065c
Loop.7.OP.OutputHighLimit	1616	0x0650
Loop.7.OP.OutputLowLimit	1617	0x0651
Loop.7.OP.Rate	1622	0x0656
Loop.7.OP.RateDisable	1623	0x0657
Loop.7.OP.RemOPH	1638	0x0666
Loop.7.OP.RemOPL	1637	0x0665
Loop.7.OP.SafeOutVal	1625	0x0659
Loop.7.OP.SBrkOP	1659	0x067b
Loop.7.OP.SensorBreakMode	1624	0x0658
Loop.7.OP.TrackEnable	1636	0x0664
Loop.7.OP.TrackOutVal	1635	0x0663
Loop.7.PID.ActiveSet	1564	0x061c
Loop.7.PID.Boundary1-2	1562	0x061a
Loop.7.PID.Boundary2-3	1563	0x061b
Loop.7.PID.CutbackHigh	1554	0x0612
Loop.7.PID.CutbackHigh2	1582	0x062e
Loop.7.PID.CutbackHigh3	1592	0x0638
Loop.7.PID.CutbackLow	1553	0x0611
Loop.7.PID.CutbackLow2	1583	0x062f
Loop.7.PID.CutbackLow3	1593	0x0639
Loop.7.PID.DerivativeTime	1545	0x0609
Loop.7.PID.DerivativeTime2	1581	0x062d
Loop.7.PID.DerivativeTime3	1591	0x0637
Loop.7.PID.IntegralTime	1544	0x0608
Loop.7.PID.IntegralTime2	1580	0x062c
Loop.7.PID.IntegralTime3	1590	0x0636
Loop.7.PID.LoopBreakTime	1576	0x0628
Loop.7.PID.LoopBreakTime2	1585	0x0631
Loop.7.PID.LoopBreakTime3	1595	0x063b
Loop.7.PID.ManualReset	1575	0x0627
Loop.7.PID.ManualReset2	1584	0x0630
Loop.7.PID.ManualReset3	1594	0x063a
Loop.7.PID.NumSets	1600	0x0640
Loop.7.PID.OutputHi	1577	0x0629
Loop.7.PID.OutputHi2	1587	0x0633
Loop.7.PID.OutputHi3	1597	0x063d
Loop.7.PID.OutputLo	1578	0x062a
Loop.7.PID.OutputLo2	1588	0x0634
Loop.7.PID.OutputLo3	1598	0x063e
Loop.7.PID.ProportionalBand	1542	0x0606
Loop.7.PID.ProportionalBand2	1579	0x062b
Loop.7.PID.ProportionalBand3	1589	0x0635

MINI8 CONTROLLER: ENGINEERING HANDBOOK

Parameter Description / Modbus address	DEC	HEX
Loop.7.PID.RelCh2Gain	1555	0x0613
Loop.7.PID.RelCh2Gain2	1586	0x0632
Loop.7.PID.RelCh2Gain3	1596	0x063c
Loop.7.PID.SchedulerRemotInput	1601	0x0641
Loop.7.PID.SchedulerType	1599	0x063f
Loop.7.Setup.CH1ControlType	1558	0x0616
Loop.7.Setup.CH2ControlType	1559	0x0617
Loop.7.Setup.ControlAction	1543	0x0607
Loop.7.Setup.DerivativeType	1561	0x0619
Loop.7.Setup.LoopType	1557	0x0615
Loop.7.Setup.PBUnits	1560	0x0618
Loop.7.SP.AltSP	1604	0x0644
Loop.7.SP.AltSPSelect	1605	0x0645
Loop.7.SP.ManualTrack	1611	0x064b
Loop.7.SP.RangeHigh	1548	0x060c
Loop.7.SP.RangeLow	1547	0x060b
Loop.7.SP.Rate	1606	0x0646
Loop.7.SP.RateDisable	1607	0x0647
Loop.7.SP.RateDone	1615	0x064f
Loop.7.SP.SP1	1549	0x060d
Loop.7.SP.SP2	1550	0x060e
Loop.7.SP.SPHighLimit	1602	0x0642
Loop.7.SP.SPLowLimit	1603	0x0643
Loop.7.SP.SPSelect	1551	0x060f
Loop.7.SP.SPTrack	1612	0x064c
Loop.7.SP.SPTrim	1608	0x0648
Loop.7.SP.SPTrimHighLimit	1609	0x0649
Loop.7.SP.SPTrimLowLimit	1610	0x064a
Loop.7.SP.TrackPV	1613	0x064d
Loop.7.SP.TrackSP	1614	0x064e
Loop.7.Tune.AutotuneEnable	1644	0x066c
Loop.7.Tune.OutputHighLimit	1641	0x0669
Loop.7.Tune.OutputLowLimit	1642	0x066a
Loop.7.Tune.Stage	1647	0x066f
Loop.7.Tune.StageTime	1648	0x0670
Loop.7.Tune.State	1646	0x066e
Loop.7.Tune.StepSize	1645	0x066d
Loop.7.Tune.Type	1640	0x0668
Loop.8.Diag.DerivativeOutContrib	1911	0x0777
Loop.8.Diag.Error	1905	0x0771
Loop.8.Diag.IntegralOutContrib	1910	0x0776
Loop.8.Diag.LoopBreakAlarm	1908	0x0774
Loop.8.Diag.LoopMode	1906	0x0772
Loop.8.Diag.PropOutContrib	1909	0x0775
Loop.8.Diag.SBrk	1912	0x0778
Loop.8.Diag.SchedCBH	1824	0x0720
Loop.8.Diag.SchedCBL	1825	0x0721
Loop.8.Diag.SchedLPBrk	1827	0x0723
Loop.8.Diag.SchedMR	1826	0x0722
Loop.8.Diag.SchedOPHi	1829	0x0725
Loop.8.Diag.SchedOPLo	1830	0x0726
Loop.8.Diag.SchedPB	1821	0x071d
Loop.8.Diag.SchedR2G	1828	0x0724
Loop.8.Diag.SchedTd	1823	0x071f
Loop.8.Diag.SchedTi	1822	0x071e

Parameter Description / Modbus address	DEC	HEX
Loop.8.Diag.TargetOutVal	1907	0x0773
Loop.8.Main.ActiveOut	1796	0x0704
Loop.8.Main.AutoMan	1802	0x070a
Loop.8.Main.Inhibit	1812	0x0714
Loop.8.Main.PV	1793	0x0701
Loop.8.Main.TargetSP	1794	0x0702
Loop.8.Main.WorkingSP	1797	0x0705
Loop.8.OP.Ch1OnOffHysteresis	1876	0x0754
Loop.8.OP.Ch1Out	1874	0x0752
Loop.8.OP.Ch2Deadband	1808	0x0710
Loop.8.OP.Ch2OnOffHysteresis	1877	0x0755
Loop.8.OP.Ch2Out	1875	0x0753
Loop.8.OP.CoolType	1885	0x075d
Loop.8.OP.EnablePowerFeedforward	1883	0x075b
Loop.8.OP.FeedForwardGain	1887	0x075f
Loop.8.OP.FeedForwardOffset	1888	0x0760
Loop.8.OP.FeedForwardTrimLimit	1889	0x0761
Loop.8.OP.FeedForwardType	1886	0x075e
Loop.8.OP.FeedForwardVal	1890	0x0762
Loop.8.OP.FF_Rem	1895	0x0767
Loop.8.OP.ManualMode	1882	0x075a
Loop.8.OP.ManualOutVal	1795	0x0703
Loop.8.OP.MeasuredPower	1884	0x075c
Loop.8.OP.OutputHighLimit	1872	0x0750
Loop.8.OP.OutputLowLimit	1873	0x0751
Loop.8.OP.Rate	1878	0x0756
Loop.8.OP.RateDisable	1879	0x0757
Loop.8.OP.RemOPH	1894	0x0766
Loop.8.OP.RemOPL	1893	0x0765
Loop.8.OP.SafeOutVal	1881	0x0759
Loop.8.OP.SBrkOP	1915	0x077b
Loop.8.OP.SensorBreakMode	1880	0x0758
Loop.8.OP.TrackEnable	1892	0x0764
Loop.8.OP.TrackOutVal	1891	0x0763
Loop.8.PID.ActiveSet	1820	0x071c
Loop.8.PID.Boundary1-2	1818	0x071a
Loop.8.PID.Boundary2-3	1819	0x071b
Loop.8.PID.CutbackHigh	1810	0x0712
Loop.8.PID.CutbackHigh2	1838	0x072e
Loop.8.PID.CutbackHigh3	1848	0x0738
Loop.8.PID.CutbackLow	1809	0x0711
Loop.8.PID.CutbackLow2	1839	0x072f
Loop.8.PID.CutbackLow3	1849	0x0739
Loop.8.PID.DerivativeTime	1801	0x0709
Loop.8.PID.DerivativeTime2	1837	0x072d
Loop.8.PID.DerivativeTime3	1847	0x0737
Loop.8.PID.IntegralTime	1800	0x0708
Loop.8.PID.IntegralTime2	1836	0x072c
Loop.8.PID.IntegralTime3	1846	0x0736
Loop.8.PID.LoopBreakTime	1832	0x0728
Loop.8.PID.LoopBreakTime2	1841	0x0731
Loop.8.PID.LoopBreakTime3	1851	0x073b
Loop.8.PID.ManualReset	1831	0x0727
Loop.8.PID.ManualReset2	1840	0x0730
Loop.8.PID.ManualReset3	1850	0x073a

MINI8 CONTROLLER: ENGINEERING HANDBOOK

Parameter Description / Modbus address	DEC	HEX	Parameter Description / Modbus address	DEC	HEX
Loop.8.PID.NumSets	1856	0x0740	Loop.9.Diag.SchedCBL	2081	0x0821
Loop.8.PID.OutputHi	1833	0x0729	Loop.9.Diag.SchedLPBrk	2083	0x0823
Loop.8.PID.OutputHi2	1843	0x0733	Loop.9.Diag.SchedMR	2082	0x0822
Loop.8.PID.OutputHi3	1853	0x073d	Loop.9.Diag.SchedOPHi	2085	0x0825
Loop.8.PID.OutputLo	1834	0x072a	Loop.9.Diag.SchedOPLo	2086	0x0826
Loop.8.PID.OutputLo2	1844	0x0734	Loop.9.Diag.SchedPB	2077	0x081D
Loop.8.PID.OutputLo3	1854	0x073e	Loop.9.Diag.SchedR2G	2084	0x0824
Loop.8.PID.ProportionalBand	1798	0x0706	Loop.9.Diag.SchedTd	2079	0x081F
Loop.8.PID.ProportionalBand2	1835	0x072b	Loop.9.Diag.SchedTi	2078	0x081E
Loop.8.PID.ProportionalBand3	1845	0x0735	Loop.9.Diag.TargetOutVal	2163	0x0873
Loop.8.PID.RelCh2Gain	1811	0x0713	Loop.9.Main.ActiveOut	2052	0x0804
Loop.8.PID.RelCh2Gain2	1842	0x0732	Loop.9.Main.AutoMan	2058	0x080A
Loop.8.PID.RelCh2Gain3	1852	0x073c	Loop.9.Main.Inhibit	2068	0x0814
Loop.8.PID.SchedulerRemotInput	1857	0x0741	Loop.9.Main.PV	2049	0x0801
Loop.8.PID.SchedulerType	1855	0x073f	Loop.9.Main.TargetSP	2050	0x0802
Loop.8.Setup.CH1ControlType	1814	0x0716	Loop.9.Main.WorkingSP	2053	0x0805
Loop.8.Setup.CH2ControlType	1815	0x0717	Loop.9.OP.Ch1OnOffHysteresis	2132	0x0854
Loop.8.Setup.ControlAction	1799	0x0707	Loop.9.OP.Ch1Out	2130	0x0852
Loop.8.Setup.DerivativeType	1817	0x0719	Loop.9.OP.Ch2Deadband	2064	0x0810
Loop.8.Setup.LoopType	1813	0x0715	Loop.9.OP.Ch2OnOffHysteresis	2133	0x0855
Loop.8.Setup.PBUnits	1816	0x0718	Loop.9.OP.Ch2Out	2131	0x0853
Loop.8.SP.AltSP	1860	0x0744	Loop.9.OP.CoolType	2141	0x085D
Loop.8.SP.AltSPSelect	1861	0x0745	Loop.9.OP.EnablePowerFeedforward	2139	0x085B
Loop.8.SP.ManualTrack	1867	0x074b	Loop.9.OP.FeedForwardGain	2143	0x085F
Loop.8.SP.RangeHigh	1804	0x070c	Loop.9.OP.FeedForwardOffset	2144	0x0860
Loop.8.SP.RangeLow	1803	0x070b	Loop.9.OP.FeedForwardTrimLimit	2145	0x0861
Loop.8.SP.Rate	1862	0x0746	Loop.9.OP.FeedForwardType	2142	0x085E
Loop.8.SP.RateDisable	1863	0x0747	Loop.9.OP.FeedForwardVal	2146	0x0862
Loop.8.SP.RateDone	1871	0x074f	Loop.9.OP.FF_Rem	2151	0x0867
Loop.8.SP.SP1	1805	0x070d	Loop.9.OP.ManualMode	2138	0x085A
Loop.8.SP.SP2	1806	0x070e	Loop.9.OP.ManualOutVal	2051	0x0803
Loop.8.SP.SPHighLimit	1858	0x0742	Loop.9.OP.MeasuredPower	2140	0x085C
Loop.8.SP.SPLowLimit	1859	0x0743	Loop.9.OP.OutputHighLimit	2128	0x0850
Loop.8.SP.SPSelect	1807	0x070f	Loop.9.OP.OutputLowLimit	2129	0x0851
Loop.8.SP.SPTrack	1868	0x074c	Loop.9.OP.Rate	2134	0x0856
Loop.8.SP.SPTrim	1864	0x0748	Loop.9.OP.RateDisable	2135	0x0857
Loop.8.SP.SPTrimHighLimit	1865	0x0749	Loop.9.OP.RemOPH	2150	0x0866
Loop.8.SP.SPTrimLowLimit	1866	0x074a	Loop.9.OP.RemOPL	2149	0x0865
Loop.8.SP.TrackPV	1869	0x074d	Loop.9.OP.SafeOutVal	2137	0x0859
Loop.8.SP.TrackSP	1870	0x074e	Loop.9.OP.SBrkOP	2171	0x087B
Loop.8.Tune.AutotuneEnable	1900	0x076c	Loop.9.OP.SensorBreakMode	2136	0x0858
Loop.8.Tune.OutputHighLimit	1897	0x0769	Loop.9.OP.TrackEnable	2148	0x0864
Loop.8.Tune.OutputLowLimit	1898	0x076a	Loop.9.OP.TrackOutVal	2147	0x0863
Loop.8.Tune.Stage	1903	0x076f	Loop.9.PID.ActiveSet	2076	0x081C
Loop.8.Tune.StageTime	1904	0x0770	Loop.9.PID.Boundary1-2	2074	0x081A
Loop.8.Tune.State	1902	0x076e	Loop.9.PID.Boundary2-3	2075	0x081B
Loop.8.Tune.StepSize	1901	0x076d	Loop.9.PID.CutbackHigh	2066	0x0812
Loop.8.Tune.Type	1896	0x0768	Loop.9.PID.CutbackHigh2	2094	0x082E
Loop.9.Diag.DerivativeOutContrib	2167	0x0877	Loop.9.PID.CutbackHigh3	2104	0x0838
Loop.9.Diag.Error	2161	0x0871	Loop.9.PID.CutbackLow	2065	0x0811
Loop.9.Diag.IntegralOutContrib	2166	0x0876	Loop.9.PID.CutbackLow2	2095	0x082F
Loop.9.Diag.LoopBreakAlarm	2164	0x0874	Loop.9.PID.CutbackLow3	2105	0x0839
Loop.9.Diag.LoopMode	2162	0x0872	Loop.9.PID.DerivativeTime	2057	0x0809
Loop.9.Diag.PropOutContrib	2165	0x0875	Loop.9.PID.DerivativeTime2	2093	0x082D
Loop.9.Diag.SBrk	2168	0x0878	Loop.9.PID.DerivativeTime3	2103	0x0837
Loop.9.Diag.SchedCBH	2080	0x0820	Loop.9.PID.IntegralTime	2056	0x0808

MINI8 CONTROLLER: ENGINEERING HANDBOOK

Parameter Description / Modbus address	DEC	HEX	Parameter Description / Modbus address	DEC	HEX
Loop.9.PID.IntegralTime2	2092	0x082C	Loop.9.Tune.Type	2152	0x0868
Loop.9.PID.IntegralTime3	2102	0x0836	Loop.10.Diag.DerivativeOutContrib	2423	0x0977
Loop.9.PID.LoopBreakTime	2088	0x0828	Loop.10.Diag.Error	2417	0x0971
Loop.9.PID.LoopBreakTime2	2097	0x0831	Loop.10.Diag.IntegralOutContrib	2422	0x0976
Loop.9.PID.LoopBreakTime3	2107	0x083B	Loop.10.Diag.LoopBreakAlarm	2420	0x0974
Loop.9.PID.ManualReset	2087	0x0827	Loop.10.Diag.LoopMode	2418	0x0972
Loop.9.PID.ManualReset2	2096	0x0830	Loop.10.Diag.PropOutContrib	2421	0x0975
Loop.9.PID.ManualReset3	2106	0x083A	Loop.10.Diag.SBrk	2424	0x0978
Loop.9.PID.NumSets	2112	0x0840	Loop.10.Diag.SchedCBH	2336	0x0920
Loop.9.PID.OutputHi	2089	0x0829	Loop.10.Diag.SchedCBL	2337	0x0921
Loop.9.PID.OutputHi2	2099	0x0833	Loop.10.Diag.SchedLPBrk	2339	0x0923
Loop.9.PID.OutputHi3	2109	0x083D	Loop.10.Diag.SchedMR	2338	0x0922
Loop.9.PID.OutputLo	2090	0x082A	Loop.10.Diag.SchedOPHi	2341	0x0925
Loop.9.PID.OutputLo2	2100	0x0834	Loop.10.Diag.SchedOPLo	2342	0x0926
Loop.9.PID.OutputLo3	2110	0x083E	Loop.10.Diag.SchedPB	2333	0x091D
Loop.9.PID.ProportionalBand	2054	0x0806	Loop.10.Diag.SchedR2G	2340	0x0924
Loop.9.PID.ProportionalBand2	2091	0x082B	Loop.10.Diag.SchedTd	2335	0x091F
Loop.9.PID.ProportionalBand3	2101	0x0835	Loop.10.Diag.SchedTi	2334	0x091E
Loop.9.PID.RelCh2Gain	2067	0x0813	Loop.10.Diag.TargetOutVal	2419	0x0973
Loop.9.PID.RelCh2Gain2	2098	0x0832	Loop.10.Main.ActiveOut	2308	0x0904
Loop.9.PID.RelCh2Gain3	2108	0x083C	Loop.10.Main.AutoMan	2314	0x090A
Loop.9.PID.SchedulerRemotelInput	2113	0x0841	Loop.10.Main.Inhibit	2324	0x0914
Loop.9.PID.SchedulerType	2111	0x083F	Loop.10.Main.PV	2305	0x0901
Loop.9.Setup.CH1ControlType	2070	0x0816	Loop.10.Main.TargetSP	2306	0x0902
Loop.9.Setup.CH2ControlType	2071	0x0817	Loop.10.Main.WorkingSP	2309	0x0905
Loop.9.Setup.ControlAction	2055	0x0807	Loop.10.OP.Ch1OnOffHysteresis	2388	0x0954
Loop.9.Setup.DerivativeType	2073	0x0819	Loop.10.OP.Ch1Out	2386	0x0952
Loop.9.Setup.LoopType	2069	0x0815	Loop.10.OP.Ch2Deadband	2320	0x0910
Loop.9.Setup.PBUnits	2072	0x0818	Loop.10.OP.Ch2OnOffHysteresis	2389	0x0955
Loop.9.SP.AltSP	2116	0x0844	Loop.10.OP.Ch2Out	2387	0x0953
Loop.9.SP.AltSPSelect	2117	0x0845	Loop.10.OP.CoolType	2397	0x095D
Loop.9.SP.ManualTrack	2123	0x084B	Loop.10.OP.EnablePowerFeedforward	2395	0x095B
Loop.9.SP.RangeHigh	2060	0x080C	Loop.10.OP.FeedForwardGain	2399	0x095F
Loop.9.SP.RangeLow	2059	0x080B	Loop.10.OP.FeedForwardOffset	2400	0x0960
Loop.9.SP.Rate	2118	0x0846	Loop.10.OP.FeedForwardTrimLimit	2401	0x0961
Loop.9.SP.RateDisable	2119	0x0847	Loop.10.OP.FeedForwardType	2398	0x095E
Loop.9.SP.RateDone	2127	0x084F	Loop.10.OP.FeedForwardVal	2402	0x0962
Loop.9.SP.SP1	2061	0x080D	Loop.10.OP.FF_Rem	2407	0x0967
Loop.9.SP.SP2	2062	0x080E	Loop.10.OP.ManualMode	2394	0x095A
Loop.9.SP.SPHighLimit	2114	0x0842	Loop.10.OP.ManualOutVal	2307	0x0903
Loop.9.SP.SPLowLimit	2115	0x0843	Loop.10.OP.MeasuredPower	2396	0x095C
Loop.9.SP.SPSelect	2063	0x080F	Loop.10.OP.OutputHighLimit	2384	0x0950
Loop.9.SP.SPTrack	2124	0x084C	Loop.10.OP.OutputLowLimit	2385	0x0951
Loop.9.SP.SPTrim	2120	0x0848	Loop.10.OP.Rate	2390	0x0956
Loop.9.SP.SPTrimHighLimit	2121	0x0849	Loop.10.OP.RateDisable	2391	0x0957
Loop.9.SP.SPTrimLowLimit	2122	0x084A	Loop.10.OP.RemOPH	2406	0x0966
Loop.9.SP.TrackPV	2125	0x084D	Loop.10.OP.RemOPL	2405	0x0965
Loop.9.SP.TrackSP	2126	0x084E	Loop.10.OP.SafeOutVal	2393	0x0959
Loop.9.Tune.AutotuneEnable	2156	0x086C	Loop.10.OP.SBrkOP	2427	0x097B
Loop.9.Tune.OutputHighLimit	2153	0x0869	Loop.10.OP.SensorBreakMode	2392	0x0958
Loop.9.Tune.OutputLowLimit	2154	0x086A	Loop.10.OP.TrackEnable	2404	0x0964
Loop.9.Tune.Stage	2159	0x086F	Loop.10.OP.TrackOutVal	2403	0x0963
Loop.9.Tune.StageTime	2160	0x0870	Loop.10.PID.ActiveSet	2332	0x091C
Loop.9.Tune.State	2158	0x086E	Loop.10.PID.Boundary1-2	2330	0x091A
Loop.9.Tune.StepSize	2157	0x086D	Loop.10.PID.Boundary2-3	2331	0x091B

MINI8 CONTROLLER: ENGINEERING HANDBOOK

Parameter Description / Modbus address	DEC	HEX	Parameter Description / Modbus address	DEC	HEX
Loop.10.PID.CutbackHigh	2322	0x0912	Loop.10.SP.TrackPV	2381	0x094D
Loop.10.PID.CutbackHigh2	2350	0x092E	Loop.10.SP.TrackSP	2382	0x094E
Loop.10.PID.CutbackHigh3	2360	0x0938	Loop.10.Tune.AutotuneEnable	2412	0x096C
Loop.10.PID.CutbackLow	2321	0x0911	Loop.10.Tune.OutputHighLimit	2409	0x0969
Loop.10.PID.CutbackLow2	2351	0x092F	Loop.10.Tune.OutputLowLimit	2410	0x096A
Loop.10.PID.CutbackLow3	2361	0x0939	Loop.10.Tune.Stage	2415	0x96F
Loop.10.PID.DerivativeTime	2313	0x0909	Loop.10.Tune.StageTime	2416	0x0970
Loop.10.PID.DerivativeTime2	2349	0x092D	Loop.10.Tune.State	2414	0x096E
Loop.10.PID.DerivativeTime3	2359	0x0937	Loop.10.Tune.StepSize	2413	0x096D
Loop.10.PID.IntegralTime	2312	0x0908	Loop.10.Tune.Type	2408	0x0968
Loop.10.PID.IntegralTime2	2348	0x092C	Loop.11.Diag.DerivativeOutContrib	2679	0x0A77
Loop.10.PID.IntegralTime3	2358	0x0936	Loop.11.Diag.Error	2673	0x0A71
Loop.10.PID.LoopBreakTime	2344	0x0928	Loop.11.Diag.IntegralOutContrib	2678	0x0A76
Loop.10.PID.LoopBreakTime2	2353	0x0931	Loop.11.Diag.LoopBreakAlarm	2676	0x0A74
Loop.10.PID.LoopBreakTime3	2363	0x093B	Loop.11.Diag.LoopMode	2674	0x0A72
Loop.10.PID.ManualReset	2343	0x0927	Loop.11.Diag.PropOutContrib	2677	0x0A75
Loop.10.PID.ManualReset2	2352	0x0930	Loop.11.Diag.SBrk	2680	0x0A78
Loop.10.PID.ManualReset3	2362	0x093A	Loop.11.Diag.SchedCBH	2592	0x0A20
Loop.10.PID.NumSets	2368	0x0940	Loop.11.Diag.SchedCBL	2593	0x0A21
Loop.10.PID.OutputHi	2345	0x0929	Loop.11.Diag.SchedLPBrk	2595	0x0A23
Loop.10.PID.OutputHi2	2355	0x0933	Loop.11.Diag.SchedMR	2594	0x0A22
Loop.10.PID.OutputHi3	2365	0x093D	Loop.11.Diag.SchedOPHi	2597	0x0A25
Loop.10.PID.OutputLo	2346	0x092A	Loop.11.Diag.SchedOPLo	2598	0x0A26
Loop.10.PID.OutputLo2	2356	0x0934	Loop.11.Diag.SchedPB	2589	0x0A1D
Loop.10.PID.OutputLo3	2366	0x093E	Loop.11.Diag.SchedR2G	2596	0x0A24
Loop.10.PID.ProportionalBand	2310	0x0906	Loop.11.Diag.SchedTd	2591	0x0A1F
Loop.10.PID.ProportionalBand2	2347	0x092B	Loop.11.Diag.SchedTi	2590	0x0A1E
Loop.10.PID.ProportionalBand3	2357	0x0935	Loop.11.Diag.TargetOutVal	2675	0x0A73
Loop.10.PID.RelCh2Gain	2323	0x0913	Loop.11.Main.ActiveOut	2564	0x0A04
Loop.10.PID.RelCh2Gain2	2354	0x0932	Loop.11.Main.AutoMan	2570	0x0A0A
Loop.10.PID.RelCh2Gain3	2364	0x093C	Loop.11.Main.Inhibit	2580	0x0A14
Loop.10.PID.SchedulerRemoteInput	2369	0x0941	Loop.11.Main.PV	2561	0x0A01
Loop.10.PID.SchedulerType	2367	0x093F	Loop.11.Main.TargetSP	2562	0x0A02
Loop.10.Setup.CH1ControlType	2326	0x0916	Loop.11.Main.WorkingSP	2565	0x0A05
Loop.10.Setup.CH2ControlType	2327	0x0917	Loop.11.OP.Ch1OnOffHysteresis	2644	0x0A54
Loop.10.Setup.ControlAction	2311	0x0907	Loop.11.OP.Ch1Out	2642	0x0A52
Loop.10.Setup.DerivativeType	2329	0x0919	Loop.11.OP.Ch2Deadband	2576	0x0A10
Loop.10.Setup.LoopType	2325	0x0915	Loop.11.OP.Ch2OnOffHysteresis	2645	0x0A55
Loop.10.Setup.PBUnits	2328	0x0918	Loop.11.OP.Ch2Out	2643	0x0A53
Loop.10.SP.AltSP	2372	0x0944	Loop.11.OP.CoolType	2653	0x0A5D
Loop.10.SP.AltSPSelect	2373	0x0945	Loop.11.OP.EnablePowerFeedforward	2651	0x0A5B
Loop.10.SP.ManualTrack	2379	0x094B	Loop.11.OP.FeedForwardGain	2655	0x0A5F
Loop.10.SP.RangeHigh	2316	0x090C	Loop.11.OP.FeedForwardOffset	2656	0x0A60
Loop.10.SP.RangeLow	2315	0x090B	Loop.11.OP.FeedForwardTrimLimit	2657	0x0A61
Loop.10.SP.Rate	2374	0x0946	Loop.11.OP.FeedForwardType	2654	0x0A5E
Loop.10.SP.RateDisable	2375	0x0947	Loop.11.OP.FeedForwardVal	2658	0x0A62
Loop.10.SP.RateDone	2383	0x094F	Loop.11.OP.FF_Rem	2663	0x0A67
Loop.10.SP.SP1	2317	0x090D	Loop.11.OP.ManualMode	2650	0x0A5A
Loop.10.SP.SP2	2318	0x090E	Loop.11.OP.ManualOutVal	2563	0x0A03
Loop.10.SP.SPHighLimit	2370	0x0942	Loop.11.OP.MeasuredPower	2652	0x0A5C
Loop.10.SP.SPLowLimit	2371	0x0943	Loop.11.OP.OutputHighLimit	2640	0x0A50
Loop.10.SP.SPSelect	2319	0x090F	Loop.11.OP.OutputLowLimit	2641	0x0A51
Loop.10.SP.SPTrack	2380	0x094C	Loop.11.OP.Rate	2646	0x0A56
Loop.10.SP.SPTrim	2376	0x0948	Loop.11.OP.RateDisable	2647	0x0A57
Loop.10.SP.SPTrimHighLimit	2377	0x0949	Loop.11.OP.RemOPH	2662	0x0A66
Loop.10.SP.SPTrimLowLimit	2378	0x094A	Loop.11.OP.RemOPL	2661	0x0A65

MINI8 CONTROLLER: ENGINEERING HANDBOOK

Parameter Description / Modbus address	DEC	HEX	Parameter Description / Modbus address	DEC	HEX
Loop.11.OP.SafeOutVal	2649	0x0A59	Loop.11.SP.SP1	2573	0x0A0D
Loop.11.OP.SBrkOP	2683	0x0A7B	Loop.11.SP.SP2	2574	0x0A0E
Loop.11.OP.SensorBreakMode	2648	0x0A58	Loop.11.SP.SPHighLimit	2626	0x0A42
Loop.11.OP.TrackEnable	2660	0x0A64	Loop.11.SP.SPLowLimit	2627	0x0A43
Loop.11.OP.TrackOutVal	2659	0x0A63	Loop.11.SP.SPSelect	2575	0x0A0F
Loop.11.PID.ActiveSet	2588	0x0A1C	Loop.11.SP.SPTrack	2636	0x0A4C
Loop.11.PID.Boundary1-2	2586	0x0A1A	Loop.11.SP.SPTrim	2632	0x0A48
Loop.11.PID.Boundary2-3	2587	0x0A1B	Loop.11.SP.SPTrimHighLimit	2633	0x0A49
Loop.11.PID.CutbackHigh	2578	0x0A12	Loop.11.SP.SPTrimLowLimit	2634	0x0A4A
Loop.11.PID.CutbackHigh2	2606	0x0A2E	Loop.11.SP.TrackPV	2637	0x0A4D
Loop.11.PID.CutbackHigh3	2616	0x0A38	Loop.11.SP.TrackSP	2638	0x0A4E
Loop.11.PID.CutbackLow	2577	0x0A11	Loop.11.Tune.AutotuneEnable	2668	0x0A6C
Loop.11.PID.CutbackLow2	2607	0x0A2F	Loop.11.Tune.OutputHighLimit	2665	0x0A69
Loop.11.PID.CutbackLow3	2617	0x0A39	Loop.11.Tune.OutputLowLimit	2666	0x0A6A
Loop.11.PID.DerivativeTime	2569	0x0A09	Loop.11.Tune.Stage	2671	0x0A6F
Loop.11.PID.DerivativeTime2	2605	0x0A2D	Loop.11.Tune.StageTime	2672	0x0A70
Loop.11.PID.DerivativeTime3	2615	0x0A37	Loop.11.Tune.State	2670	0x0A6E
Loop.11.PID.IntegralTime	2568	0x0A08	Loop.11.Tune.StepSize	2669	0x0A6D
Loop.11.PID.IntegralTime2	2604	0x0A2C	Loop.11.Tune.Type	2664	0x0A68
Loop.11.PID.IntegralTime3	2614	0x0A36	Loop.12.Diag.DerivativeOutContrib	2935	0x0B77
Loop.11.PID.LoopBreakTime	2600	0x0A28	Loop.12.Diag.Error	2929	0x0B71
Loop.11.PID.LoopBreakTime2	2609	0x0A31	Loop.12.Diag.IntegralOutContrib	2934	0x0B76
Loop.11.PID.LoopBreakTime3	2619	0x0A3B	Loop.12.Diag.LoopBreakAlarm	2932	0x0B74
Loop.11.PID.ManualReset	2599	0x0A27	Loop.12.Diag.LoopMode	2930	0x0B72
Loop.11.PID.ManualReset2	2608	0x0A30	Loop.12.Diag.PropOutContrib	2933	0x0B75
Loop.11.PID.ManualReset3	2618	0x0A3A	Loop.12.Diag.SBrk	2936	0x0B78
Loop.11.PID.NumSets	2624	0x0A40	Loop.12.Diag.SchedCBH	2848	0x0B20
Loop.11.PID.OutputHi	2601	0x0A29	Loop.12.Diag.SchedCBL	2849	0x0B21
Loop.11.PID.OutputHi2	2611	0x0A33	Loop.12.Diag.SchedLPBrk	2851	0x0B23
Loop.11.PID.OutputHi3	2621	0x0A3D	Loop.12.Diag.SchedMR	2850	0x0B22
Loop.11.PID.OutputLo	2602	0x0A2A	Loop.12.Diag.SchedOPHi	2853	0x0B25
Loop.11.PID.OutputLo2	2612	0x0A34	Loop.12.Diag.SchedOPLo	2854	0x0B26
Loop.11.PID.OutputLo3	2622	0x0A3E	Loop.12.Diag.SchedPB	2845	0x0B1D
Loop.11.PID.ProportionalBand	2566	0x0A06	Loop.12.Diag.SchedR2G	2852	0x0B24
Loop.11.PID.ProportionalBand2	2603	0x0A2B	Loop.12.Diag.SchedTd	2847	0x0B1F
Loop.11.PID.ProportionalBand3	2613	0x0A35	Loop.12.Diag.SchedTi	2846	0x0B1E
Loop.11.PID.RelCh2Gain	2579	0x0A13	Loop.12.Diag.TargetOutVal	2931	0x0B73
Loop.11.PID.RelCh2Gain2	2610	0x0A32	Loop.12.Main.ActiveOut	2820	0x0B04
Loop.11.PID.RelCh2Gain3	2620	0x0A3C	Loop.12.Main.AutoMan	2826	0x0B0A
Loop.11.PID.SchedulerRemoteInput	2625	0x0A41	Loop.12.Main.Inhibit	2836	0x0B14
Loop.11.PID.SchedulerType	2623	0x0A3F	Loop.12.Main.PV	2817	0x0B01
Loop.11.Setup.CH1ControlType	2582	0x0A16	Loop.12.Main.TargetSP	2818	0x0B02
Loop.11.Setup.CH2ControlType	2583	0x0A17	Loop.12.Main.WorkingSP	2821	0x0B05
Loop.11.Setup.ControlAction	2567	0x0A07	Loop.12.OP.Ch1OnOffHysteresis	2900	0x0B54
Loop.11.Setup.DerivativeType	2585	0x0A19	Loop.12.OP.Ch1Out	2898	0x0B52
Loop.11.Setup.LoopType	2581	0x0A15	Loop.12.OP.Ch2Deadband	2832	0x0B10
Loop.11.Setup.PBUnits	2584	0x0A18	Loop.12.OP.Ch2OnOffHysteresis	2901	0x0B55
Loop.11.SP.AltSP	2628	0x0A44	Loop.12.OP.Ch2Out	2899	0x0B53
Loop.11.SP.AltSPSelect	2629	0x0A45	Loop.12.OP.CoolType	2909	0x0B5D
Loop.11.SP.ManualTrack	2635	0x0A4B	Loop.12.OP.EnablePowerFeedforward	2907	0x0B5B
Loop.11.SP.RangeHigh	2572	0x0A0C	Loop.12.OP.FeedForwardGain	2911	0x0B5F
Loop.11.SP.RangeLow	2571	0x0A0B	Loop.12.OP.FeedForwardOffset	2912	0x0B60
Loop.11.SP.Rate	2630	0x0A46	Loop.12.OP.FeedForwardTrimLimit	2913	0x0B61
Loop.11.SP.RateDisable	2631	0x0A47	Loop.12.OP.FeedForwardType	2910	0x0B5E
Loop.11.SP.RateDone	2639	0x0A4F	Loop.12.OP.FeedForwardVal	2914	0x0B62

MINI8 CONTROLLER: ENGINEERING HANDBOOK

Parameter Description / Modbus address	DEC	HEX
Loop.12.OP.FF_Rem	2919	0x0B67
Loop.12.OP.ManualMode	2906	0x0B5A
Loop.12.OP.ManualOutVal	2819	0x0B03
Loop.12.OP.MeasuredPower	2908	0x0B5C
Loop.12.OP.OutputHighLimit	2896	0x0B50
Loop.12.OP.OutputLowLimit	2897	0x0B51
Loop.12.OP.Rate	2902	0x0B56
Loop.12.OP.RateDisable	2903	0x0B57
Loop.12.OP.RemOPH	2918	0x0B66
Loop.12.OP.RemOPL	2917	0x0B65
Loop.12.OP.SafeOutVal	2905	0x0B59
Loop.12.OP.SBrkOP	2939	0x0B7B
Loop.12.OP.SensorBreakMode	2904	0x0B58
Loop.12.OP.TrackEnable	2916	0x0B64
Loop.12.OP.TrackOutVal	2915	0x0B63
Loop.12.PID.ActiveSet	2844	0x0B1C
Loop.12.PID.Boundary1-2	2842	0x0B1A
Loop.12.PID.Boundary2-3	2843	0x0B1B
Loop.12.PID.CutbackHigh	2834	0x0B12
Loop.12.PID.CutbackHigh2	2862	0x0B2E
Loop.12.PID.CutbackHigh3	2872	0x0B38
Loop.12.PID.CutbackLow	2833	0x0B11
Loop.12.PID.CutbackLow2	2863	0x0B2F
Loop.12.PID.CutbackLow3	2873	0x0B39
Loop.12.PID.DerivativeTime	2825	0x0B09
Loop.12.PID.DerivativeTime2	2861	0x0B2D
Loop.12.PID.DerivativeTime3	2871	0x0B37
Loop.12.PID.IntegralTime	2824	0x0B08
Loop.12.PID.IntegralTime2	2860	0x0B2C
Loop.12.PID.IntegralTime3	2870	0x0B36
Loop.12.PID.LoopBreakTime	2856	0x0B28
Loop.12.PID.LoopBreakTime2	2865	0x0B31
Loop.12.PID.LoopBreakTime3	2875	0x0B3B
Loop.12.PID.ManualReset	2855	0x0B27
Loop.12.PID.ManualReset2	2864	0x0B30
Loop.12.PID.ManualReset3	2874	0x0B3A
Loop.12.PID.NumSets	2880	0x0B40
Loop.12.PID.OutputHi	2857	0x0B29
Loop.12.PID.OutputHi2	2867	0x0B33
Loop.12.PID.OutputHi3	2877	0x0B3D
Loop.12.PID.OutputLo	2858	0x0B2A
Loop.12.PID.OutputLo2	2868	0x0B34
Loop.12.PID.OutputLo3	2878	0x0B3E
Loop.12.PID.ProportionalBand	2822	0x0B06
Loop.12.PID.ProportionalBand2	2859	0x0B2B
Loop.12.PID.ProportionalBand3	2869	0x0B35
Loop.12.PID.RelCh2Gain	2835	0x0B13
Loop.12.PID.RelCh2Gain2	2866	0x0B32
Loop.12.PID.RelCh2Gain3	2876	0x0B3C
Loop.12.PID.SchedulerRemoteInput	2881	0x0B41
Loop.12.PID.SchedulerType	2879	0x0B3F
Loop.12.Setup.CH1ControlType	2838	0x0B16
Loop.12.Setup.CH2ControlType	2839	0x0B17
Loop.12.Setup.ControlAction	2823	0x0B07
Loop.12.Setup.DerivativeType	2841	0x0B19
Loop.12.Setup.LoopType	2837	0x0B15

Parameter Description / Modbus address	DEC	HEX
Loop.12.Setup.PBUnits	2840	0x0B18
Loop.12.SP.AltSP	2884	0x0B44
Loop.12.SP.AltSPSelect	2885	0x0B45
Loop.12.SP.ManualTrack	2891	0x0B4B
Loop.12.SP.RangeHigh	2828	0x0B0C
Loop.12.SP.RangeLow	2827	0x0B0B
Loop.12.SP.Rate	2886	0x0B46
Loop.12.SP.RateDisable	2887	0x0B47
Loop.12.SP.RateDone	2895	0x0B4F
Loop.12.SP.SP1	2829	0x0B0D
Loop.12.SP.SP2	2830	0x0B0E
Loop.12.SP.SPHighLimit	2882	0x0B42
Loop.12.SP.SPLowLimit	2883	0x0B43
Loop.12.SP.SPSelect	2831	0x0B0F
Loop.12.SP.SPTrack	2892	0x0B4C
Loop.12.SP.SPTrim	2888	0x0B48
Loop.12.SP.SPTrimHighLimit	2889	0x0B49
Loop.12.SP.SPTrimLowLimit	2890	0x0B4A
Loop.12.SP.TrackPV	2893	0x0B4D
Loop.12.SP.TrackSP	2894	0x0B4E
Loop.12.Tune.AutotuneEnable	2924	0x0B6C
Loop.12.Tune.OutputHighLimit	2921	0x0B69
Loop.12.Tune.OutputLowLimit	2922	0x0B6A
Loop.12.Tune.Stage	2927	0x0B6F
Loop.12.Tune.StageTime	2928	0x0B70
Loop.12.Tune.State	2926	0x0B6E
Loop.12.Tune.StepSize	2925	0x0B6D
Loop.12.Tune.Type	2920	0x0B68
Loop.13.Diag.DerivativeOutContrib	3191	0x0C77
Loop.13.Diag.Error	3185	0x0C71
Loop.13.Diag.IntegralOutContrib	3190	0x0C76
Loop.13.Diag.LoopBreakAlarm	3188	0x0C74
Loop.13.Diag.LoopMode	3186	0x0C72
Loop.13.Diag.PropOutContrib	3189	0x0C75
Loop.13.Diag.SBrk	3192	0x0C78
Loop.13.Diag.SchedCBH	3104	0x0C20
Loop.13.Diag.SchedCBL	3105	0x0C21
Loop.13.Diag.SchedLPBrk	3107	0x0C23
Loop.13.Diag.SchedMR	3106	0x0C22
Loop.13.Diag.SchedOPHi	3109	0x0C25
Loop.13.Diag.SchedOPLo	3110	0x0C26
Loop.13.Diag.SchedPB	3101	0x0C1D
Loop.13.Diag.SchedR2G	3108	0x0C24
Loop.13.Diag.SchedTd	3103	0x0C1F
Loop.13.Diag.SchedTi	3102	0x0C1E
Loop.13.Diag.TargetOutVal	3187	0x0C73
Loop.13.Main.ActiveOut	3076	0x0C04
Loop.13.Main.AutoMan	3082	0x0C0A
Loop.13.Main.Inhibit	3092	0x0C14
Loop.13.Main.PV	3073	0x0C01
Loop.13.Main.TargetSP	3074	0x0C02
Loop.13.Main.WorkingSP	3077	0x0C05
Loop.13.OP.Ch1OnOffHysteresis	3156	0x0C54
Loop.13.OP.Ch1Out	3154	0x0C52
Loop.13.OP.Ch2Deadband	3088	0x0C10
Loop.13.OP.Ch2OnOffHysteresis	3157	0x0C55

MINI8 CONTROLLER: ENGINEERING HANDBOOK

Parameter Description / Modbus address	DEC	HEX	Parameter Description / Modbus address	DEC	HEX
Loop.13.OP.Ch2Out	3155	0x0C53	Loop.13.PID.RelCh2Gain2	3122	0x0C32
Loop.13.OP.CoolType	3165	0x0C5D	Loop.13.PID.RelCh2Gain3	3132	0x0C3C
Loop.13.OP.EnablePowerFeedforward	3163	0x0C5B	Loop.13.PID.SchedulerRemotelnput	3137	0x0C41
Loop.13.OP.FeedForwardGain	3167	0x0C5F	Loop.13.PID.SchedulerType	3135	0x0C3F
Loop.13.OP.FeedForwardOffset	3168	0x0C60	Loop.13.Setup.CH1ControlType	3094	0x0C16
Loop.13.OP.FeedForwardTrimLimit	3169	0x0C61	Loop.13.Setup.CH2ControlType	3095	0x0C17
Loop.13.OP.FeedForwardType	3166	0x0C5E	Loop.13.Setup.ControlAction	3079	0x0C07
Loop.13.OP.FeedForwardVal	3170	0x0C62	Loop.13.Setup.DerivativeType	3097	0x0C19
Loop.13.OP.FF_Rem	3175	0x0C67	Loop.13.Setup.LoopType	3093	0x0C15
Loop.13.OP.ManualMode	3162	0x0C5A	Loop.13.Setup.PBUnits	3096	0x0C18
Loop.13.OP.ManualOutVal	3075	0x0C03	Loop.13.SP.AltSP	3140	0x0C44
Loop.13.OP.MeasuredPower	3164	0x0C5C	Loop.13.SP.AltSPSelect	3141	0x0C45
Loop.13.OP.OutputHighLimit	3152	0x0C50	Loop.13.SP.ManualTrack	3147	0x0C4B
Loop.13.OP.OutputLowLimit	3153	0x0C51	Loop.13.SP.RangeHigh	3084	0x0C0C
Loop.13.OP.Rate	3158	0x0C56	Loop.13.SP.RangeLow	3083	0x0C0B
Loop.13.OP.RateDisable	3159	0x0C57	Loop.13.SP.Rate	3142	0x0C46
Loop.13.OP.RemOPH	3174	0x0C66	Loop.13.SP.RateDisable	3143	0x0C47
Loop.13.OP.RemOPL	3173	0x0C65	Loop.13.SP.RateDone	3151	0x0C4F
Loop.13.OP.SafeOutVal	3161	0x0C59	Loop.13.SP.SP1	3085	0x0C0D
Loop.13.OP.SBrkOP	3195	0x0C7B	Loop.13.SP.SP2	3086	0x0C0E
Loop.13.OP.SensorBreakMode	3160	0x0C58	Loop.13.SP.SPHighLimit	3138	0x0C42
Loop.13.OP.TrackEnable	3172	0x0C64	Loop.13.SP.SPLowLimit	3139	0x0C43
Loop.13.OP.TrackOutVal	3171	0x0C63	Loop.13.SP.SPSelect	3087	0x0C0F
Loop.13.PID.ActiveSet	3100	0x0C1C	Loop.13.SP.SPTrack	3148	0x0C4C
Loop.13.PID.Boundary1-2	3098	0x0C1A	Loop.13.SP.SPTrim	3144	0x0C48
Loop.13.PID.Boundary2-3	3099	0x0C1B	Loop.13.SP.SPTrimHighLimit	3145	0x0C49
Loop.13.PID.CutbackHigh	3090	0x0C12	Loop.13.SP.SPTrimLowLimit	3146	0x0C4A
Loop.13.PID.CutbackHigh2	3118	0x0C2E	Loop.13.SP.TrackPV	3149	0x0C4D
Loop.13.PID.CutbackHigh3	3128	0x0C38	Loop.13.SP.TrackSP	3150	0x0C4E
Loop.13.PID.CutbackLow	3089	0x0C11	Loop.13.Tune.AutotuneEnable	3180	0x0C6C
Loop.13.PID.CutbackLow2	3119	0x0C2F	Loop.13.Tune.OutputHighLimit	3177	0x0C69
Loop.13.PID.CutbackLow3	3129	0x0C39	Loop.13.Tune.OutputLowLimit	3178	0x0C6A
Loop.13.PID.DerivativeTime	3081	0x0C09	Loop.13.Tune.Stage	3183	0x0C6F
Loop.13.PID.DerivativeTime2	3117	0x0C2D	Loop.13.Tune.StageTime	3184	0x0C70
Loop.13.PID.DerivativeTime3	3127	0x0C37	Loop.13.Tune.State	3182	0x0C6E
Loop.13.PID.IntegralTime	3080	0x0C08	Loop.13.Tune.StepSize	3181	0x0C6D
Loop.13.PID.IntegralTime2	3116	0x0C2C	Loop.13.Tune.Type	3176	0x0C68
Loop.13.PID.IntegralTime3	3126	0x0C36	Loop.14.Diag.DerivativeOutContrib	3447	0x0D77
Loop.13.PID.LoopBreakTime	3112	0x0C28	Loop.14.Diag.Error	3441	0x0D71
Loop.13.PID.LoopBreakTime2	3121	0x0C31	Loop.14.Diag.IntegralOutContrib	3446	0x0D76
Loop.13.PID.LoopBreakTime3	3131	0x0C3B	Loop.14.Diag.LoopBreakAlarm	3444	0x0D74
Loop.13.PID.ManualReset	3111	0x0C27	Loop.14.Diag.LoopMode	3442	0x0D72
Loop.13.PID.ManualReset2	3120	0x0C30	Loop.14.Diag.PropOutContrib	3445	0x0D75
Loop.13.PID.ManualReset3	3130	0x0C3A	Loop.14.Diag.SBrk	3448	0x0D78
Loop.13.PID.NumSets	3136	0x0C40	Loop.14.Diag.SchedCBH	3360	0x0D20
Loop.13.PID.OutputHi	3113	0x0C29	Loop.14.Diag.SchedCBL	3361	0x0D21
Loop.13.PID.OutputHi2	3123	0x0C33	Loop.14.Diag.SchedLPBrk	3363	0x0D23
Loop.13.PID.OutputHi3	3133	0x0C3D	Loop.14.Diag.SchedMR	3362	0x0D22
Loop.13.PID.OutputLo	3114	0x0C2A	Loop.14.Diag.SchedOPHi	3365	0x0D25
Loop.13.PID.OutputLo2	3124	0x0C34	Loop.14.Diag.SchedOPLo	3366	0x0D26
Loop.13.PID.OutputLo3	3134	0x0C3E	Loop.14.Diag.SchedPB	3357	0x0D1D
Loop.13.PID.ProportionalBand	3078	0x0C06	Loop.14.Diag.SchedR2G	3364	0x0D24
Loop.13.PID.ProportionalBand2	3115	0x0C2B	Loop.14.Diag.SchedTd	3359	0x0D1F
Loop.13.PID.ProportionalBand3	3125	0x0C35	Loop.14.Diag.SchedTi	3358	0x0D1E
Loop.13.PID.RelCh2Gain	3091	0x0C13	Loop.14.Diag.TargetOutVal	3443	0x0D73

MINI8 CONTROLLER: ENGINEERING HANDBOOK

Parameter Description / Modbus address	DEC	HEX	Parameter Description / Modbus address	DEC	HEX
Loop.14.Main.ActiveOut	3332	0x0D04	Loop.14.PID.OutputHi2	3379	0x0D33
Loop.14.Main.AutoMan	3338	0x0D0A	Loop.14.PID.OutputHi3	3389	0x0D3D
Loop.14.Main.Inhibit	3348	0x0D14	Loop.14.PID.OutputLo	3370	0x0D2A
Loop.14.Main.PV	3329	0x0D01	Loop.14.PID.OutputLo2	3380	0x0D34
Loop.14.Main.TargetSP	3330	0x0D02	Loop.14.PID.OutputLo3	3390	0x0D3E
Loop.14.Main.WorkingSP	3333	0x0D05	Loop.14.PID.ProportionalBand	3334	0x0D06
Loop.14.OP.Ch1OnOffHysteresis	3412	0x0D54	Loop.14.PID.ProportionalBand2	3371	0x0D2B
Loop.14.OP.Ch1Out	3410	0x0D52	Loop.14.PID.ProportionalBand3	3381	0x0D35
Loop.14.OP.Ch2Deadband	3344	0x0D10	Loop.14.PID.RelCh2Gain	3347	0x0D13
Loop.14.OP.Ch2OnOffHysteresis	3413	0x0D55	Loop.14.PID.RelCh2Gain2	3378	0x0D32
Loop.14.OP.Ch2Out	3411	0x0D53	Loop.14.PID.RelCh2Gain3	3388	0x0D3C
Loop.14.OP.CoolType	3421	0x0D5D	Loop.14.PID.SchedulerRemotelInput	3393	0x0D41
Loop.14.OP.EnablePowerFeedforward	3419	0x0D5B	Loop.14.PID.SchedulerType	3391	0x0D3F
Loop.14.OP.FeedForwardGain	3423	0x0D5F	Loop.14.Setup.CH1ControlType	3350	0x0D16
Loop.14.OP.FeedForwardOffset	3424	0x0D60	Loop.14.Setup.CH2ControlType	3351	0x0D17
Loop.14.OP.FeedForwardTrimLimit	3425	0x0D61	Loop.14.Setup.ControlAction	3335	0x0D07
Loop.14.OP.FeedForwardType	3422	0x0D5E	Loop.14.Setup.DerivativeType	3353	0x0D19
Loop.14.OP.FeedForwardVal	3426	0x0D62	Loop.14.Setup.LoopType	3349	0x0D15
Loop.14.OP.FF_Rem	3431	0x0D67	Loop.14.Setup.PBUnits	3352	0x0D18
Loop.14.OP.ManualMode	3418	0x0D5A	Loop.14.SP.AltSP	3396	0x0D44
Loop.14.OP.ManualOutVal	3331	0x0D03	Loop.14.SP.AltSPSelect	3397	0x0D45
Loop.14.OP.MeasuredPower	3420	0x0D5C	Loop.14.SP.ManualTrack	3403	0x0D4B
Loop.14.OP.OutputHighLimit	3408	0x0D50	Loop.14.SP.RangeHigh	3340	0x0D0C
Loop.14.OP.OutputLowLimit	3409	0x0D51	Loop.14.SP.RangeLow	3339	0x0D0B
Loop.14.OP.Rate	3414	0x0D56	Loop.14.SP.Rate	3398	0x0D46
Loop.14.OP.RateDisable	3415	0x0D57	Loop.14.SP.RateDisable	3399	0x0D47
Loop.14.OP.RemOPH	3430	0x0D66	Loop.14.SP.RateDone	3407	0x0D4F
Loop.14.OP.RemOPL	3429	0x0D65	Loop.14.SP.SP1	3341	0x0D0D
Loop.14.OP.SafeOutVal	3417	0x0D59	Loop.14.SP.SP2	3342	0x0D0E
Loop.14.OP.SBrkOP	3451	0x0D7B	Loop.14.SP.SPHighLimit	3394	0x0D42
Loop.14.OP.SensorBreakMode	3416	0x0D58	Loop.14.SP.SPLowLimit	3395	0x0D43
Loop.14.OP.TrackEnable	3428	0x0D64	Loop.14.SP.SPSelect	3343	0x0D0F
Loop.14.OP.TrackOutVal	3427	0x0D63	Loop.14.SP.SPTrack	3404	0x0D4C
Loop.14.PID.ActiveSet	3356	0x0D1C	Loop.14.SP.SPTrim	3400	0x0D48
Loop.14.PID.Boundary1-2	3354	0x0D1A	Loop.14.SP.SPTrimHighLimit	3401	0x0D49
Loop.14.PID.Boundary2-3	3355	0x0D1B	Loop.14.SP.SPTrimLowLimit	3402	0x0D4A
Loop.14.PID.CutbackHigh	3346	0x0D12	Loop.14.SP.TrackPV	3405	0x0D4D
Loop.14.PID.CutbackHigh2	3374	0x0D2E	Loop.14.SP.TrackSP	3406	0x0D4E
Loop.14.PID.CutbackHigh3	3384	0x0D38	Loop.14.Tune.AutotuneEnable	3436	0x0D6C
Loop.14.PID.CutbackLow	3345	0x0D11	Loop.14.Tune.OutputHighLimit	3433	0x0D69
Loop.14.PID.CutbackLow2	3375	0x0D2F	Loop.14.Tune.OutputLowLimit	3434	0x0D6A
Loop.14.PID.CutbackLow3	3385	0x0D39	Loop.14.Tune.Stage	3439	0x0D6F
Loop.14.PID.DerivativeTime	3337	0x0D09	Loop.14.Tune.StageTime	3440	0x0D70
Loop.14.PID.DerivativeTime2	3373	0x0D2D	Loop.14.Tune.State	3438	0x0D6E
Loop.14.PID.DerivativeTime3	3383	0x0D37	Loop.14.Tune.StepSize	3437	0x0D6D
Loop.14.PID.IntegralTime	3336	0x0D08	Loop.14.Tune.Type	3432	0x0D68
Loop.14.PID.IntegralTime2	3372	0x0D2C	Loop.15.Diag.DerivativeOutContrib	3703	0x0E77
Loop.14.PID.IntegralTime3	3382	0x0D36	Loop.15.Diag.Error	3697	0x0E71
Loop.14.PID.LoopBreakTime	3368	0x0D28	Loop.15.Diag.IntegralOutContrib	3702	0x0E76
Loop.14.PID.LoopBreakTime2	3377	0x0D31	Loop.15.Diag.LoopBreakAlarm	3700	0x0E74
Loop.14.PID.LoopBreakTime3	3387	0x0D3B	Loop.15.Diag.LoopMode	3698	0x0E72
Loop.14.PID.ManualReset	3367	0x0D27	Loop.15.Diag.PropOutContrib	3701	0x0E75
Loop.14.PID.ManualReset2	3376	0x0D30	Loop.15.Diag.SBrk	3704	0x0E78
Loop.14.PID.ManualReset3	3386	0x0D3A	Loop.15.Diag.SchedCBH	3616	0x0E20
Loop.14.PID.NumSets	3392	0x0D40	Loop.15.Diag.SchedCBL	3617	0x0E21
Loop.14.PID.OutputHi	3369	0x0D29	Loop.15.Diag.SchedLPBrk	3619	0x0E23

MINI8 CONTROLLER: ENGINEERING HANDBOOK

Parameter Description / Modbus address	DEC	HEX	Parameter Description / Modbus address	DEC	HEX
Loop.15.Diag.SchedMR	3618	0x0E22	Loop.15.PID.IntegralTime3	3638	0x0E36
Loop.15.Diag.SchedOPHi	3621	0x0E25	Loop.15.PID.LoopBreakTime	3624	0x0E28
Loop.15.Diag.SchedOPLo	3622	0x0E26	Loop.15.PID.LoopBreakTime2	3633	0x0E31
Loop.15.Diag.SchedPB	3613	0x0E1D	Loop.15.PID.LoopBreakTime3	3643	0x0E3B
Loop.15.Diag.SchedR2G	3620	0x0E24	Loop.15.PID.ManualReset	3623	0x0E27
Loop.15.Diag.SchedTd	3615	0x0E1F	Loop.15.PID.ManualReset2	3632	0x0E30
Loop.15.Diag.SchedTi	3614	0x0E1E	Loop.15.PID.ManualReset3	3642	0x0E3A
Loop.15.Diag.TargetOutVal	3699	0x0E73	Loop.15.PID.NumSets	3648	0x0E40
Loop.15.Main.ActiveOut	3588	0x0E04	Loop.15.PID.OutputHi	3625	0x0E29
Loop.15.Main.AutoMan	3594	0x0E0A	Loop.15.PID.OutputHi2	3635	0x0E33
Loop.15.Main.Inhibit	3604	0x0E14	Loop.15.PID.OutputHi3	3645	0x0E3D
Loop.15.Main.PV	3585	0x0E01	Loop.15.PID.OutputLo	3626	0x0E2A
Loop.15.Main.TargetSP	3586	0x0E02	Loop.15.PID.OutputLo2	3636	0x0E34
Loop.15.Main.WorkingSP	3589	0x0E05	Loop.15.PID.OutputLo3	3646	0x0E3E
Loop.15.OP.Ch1OnOffHysteresis	3668	0x0E54	Loop.15.PID.ProportionalBand	3590	0x0E06
Loop.15.OP.Ch1Out	3666	0x0E52	Loop.15.PID.ProportionalBand2	3627	0x0E2B
Loop.15.OP.Ch2Deadband	3600	0x0E10	Loop.15.PID.ProportionalBand3	3637	0x0E35
Loop.15.OP.Ch2OnOffHysteresis	3669	0x0E55	Loop.15.PID.RelCh2Gain	3603	0x0E13
Loop.15.OP.Ch2Out	3667	0x0E53	Loop.15.PID.RelCh2Gain2	3634	0x0E32
Loop.15.OP.CoolType	3677	0x0E5D	Loop.15.PID.RelCh2Gain3	3644	0x0E3C
Loop.15.OP.EnablePowerFeedforward	3675	0x0E5B	Loop.15.PID.SchedulerRemotelnput	3649	0x0E41
Loop.15.OP.FeedForwardGain	3679	0x0E5F	Loop.15.PID.SchedulerType	3647	0x0E3F
Loop.15.OP.FeedForwardOffset	3680	0x0E60	Loop.15.Setup.CH1ControlType	3606	0x0E16
Loop.15.OP.FeedForwardTrimLimit	3681	0x0E61	Loop.15.Setup.CH2ControlType	3607	0x0E17
Loop.15.OP.FeedForwardType	3678	0x0E5E	Loop.15.Setup.ControlAction	3591	0x0E07
Loop.15.OP.FeedForwardVal	3682	0x0E62	Loop.15.Setup.DerivativeType	3609	0x0E19
Loop.15.OP.FF_Rem	3687	0x0E67	Loop.15.Setup.LoopType	3605	0x0E15
Loop.15.OP.ManualMode	3674	0x0E5A	Loop.15.Setup.PBUnits	3608	0x0E18
Loop.15.OP.ManualOutVal	3587	0x0E03	Loop.15.SP.AltSP	3652	0x0E44
Loop.15.OP.MeasuredPower	3676	0x0E5C	Loop.15.SP.AltSPSelect	3653	0x0E45
Loop.15.OP.OutputHighLimit	3664	0x0E50	Loop.15.SP.ManualTrack	3659	0x0E4B
Loop.15.OP.OutputLowLimit	3665	0x0E51	Loop.15.SP.RangeHigh	3596	0x0E0C
Loop.15.OP.Rate	3670	0x0E56	Loop.15.SP.RangeLow	3595	0x0E0B
Loop.15.OP.RateDisable	3671	0x0E57	Loop.15.SP.Rate	3654	0x0E46
Loop.15.OP.RemOPH	3686	0x0E66	Loop.15.SP.RateDisable	3655	0x0E47
Loop.15.OP.RemOPL	3685	0x0E65	Loop.15.SP.RateDone	3663	0x0E4F
Loop.15.OP.SafeOutVal	3673	0x0E59	Loop.15.SP.SP1	3597	0x0E0D
Loop.15.OP.SBrkOP	3707	0x0E7B	Loop.15.SP.SP2	3598	0x0E0E
Loop.15.OP.SensorBreakMode	3672	0x0E58	Loop.15.SP.SPHighLimit	3650	0x0E42
Loop.15.OP.TrackEnable	3684	0x0E64	Loop.15.SP.SPLowLimit	3651	0x0E43
Loop.15.OP.TrackOutVal	3683	0x0E63	Loop.15.SP.SPSelect	3599	0x0E0F
Loop.15.PID.ActiveSet	3612	0x0E1C	Loop.15.SP.SPTrack	3660	0x0E4C
Loop.15.PID.Boundary1-2	3610	0x0E1A	Loop.15.SP.SPTrim	3656	0x0E48
Loop.15.PID.Boundary2-3	3611	0x0E1B	Loop.15.SP.SPTrimHighLimit	3657	0x0E49
Loop.15.PID.CutbackHigh	3602	0x0E12	Loop.15.SP.SPTrimLowLimit	3658	0x0E4A
Loop.15.PID.CutbackHigh2	3630	0x0E2E	Loop.15.SP.TrackPV	3661	0x0E4D
Loop.15.PID.CutbackHigh3	3640	0x0E38	Loop.15.SP.TrackSP	3662	0x0E4E
Loop.15.PID.CutbackLow	3601	0x0E11	Loop.15.Tune.AutotuneEnable	3692	0x0E6C
Loop.15.PID.CutbackLow2	3631	0x0E2F	Loop.15.Tune.OutputHighLimit	3689	0x0E69
Loop.15.PID.CutbackLow3	3641	0x0E39	Loop.15.Tune.OutputLowLimit	3690	0x0E6A
Loop.15.PID.DerivativeTime	3593	0x0E09	Loop.15.Tune.Stage	3695	0x0E6F
Loop.15.PID.DerivativeTime2	3629	0x0E2D	Loop.15.Tune.StageTime	3696	0x0E70
Loop.15.PID.DerivativeTime3	3639	0x0E37	Loop.15.Tune.State	3694	0x0E6E
Loop.15.PID.IntegralTime	3592	0x0E08	Loop.15.Tune.StepSize	3693	0x0E6D
Loop.15.PID.IntegralTime2	3628	0x0E2C	Loop.15.Tune.Type	3688	0x0E68

MINI8 CONTROLLER: ENGINEERING HANDBOOK

Parameter Description / Modbus address	DEC	HEX	Parameter Description / Modbus address	DEC	HEX
Loop.16.Diag.DerivativeOutContrib	3959	0x0F77	Loop.16.PID.CutbackHigh3	3896	0x0F38
Loop.16.Diag.Error	3953	0x0F71	Loop.16.PID.CutbackLow	3857	0x0F11
Loop.16.Diag.IntegralOutContrib	3958	0x0F76	Loop.16.PID.CutbackLow2	3887	0x0F2F
Loop.16.Diag.LoopBreakAlarm	3956	0x0F74	Loop.16.PID.CutbackLow3	3897	0x0F39
Loop.16.Diag.LoopMode	3954	0x0F72	Loop.16.PID.DerivativeTime	3849	0x0F09
Loop.16.Diag.PropOutContrib	3957	0x0F75	Loop.16.PID.DerivativeTime2	3885	0x0F2D
Loop.16.Diag.SBrk	3960	0x0F78	Loop.16.PID.DerivativeTime3	3895	0x0F37
Loop.16.Diag.SchedCBH	3872	0x0F20	Loop.16.PID.IntegralTime	3848	0x0F08
Loop.16.Diag.SchedCBL	3873	0x0F21	Loop.16.PID.IntegralTime2	3884	0x0F2C
Loop.16.Diag.SchedLPBrk	3875	0x0F23	Loop.16.PID.IntegralTime3	3894	0x0F36
Loop.16.Diag.SchedMR	3874	0x0F22	Loop.16.PID.LoopBreakTime	3880	0x0F28
Loop.16.Diag.SchedOPHi	3877	0x0F25	Loop.16.PID.LoopBreakTime2	3889	0x0F31
Loop.16.Diag.SchedOPLo	3878	0x0F26	Loop.16.PID.LoopBreakTime3	3899	0x0F3B
Loop.16.Diag.SchedPB	3869	0x0F1D	Loop.16.PID.ManualReset	3879	0x0F27
Loop.16.Diag.SchedR2G	3876	0x0F24	Loop.16.PID.ManualReset2	3888	0x0F30
Loop.16.Diag.SchedTd	3871	0x0F1F	Loop.16.PID.ManualReset3	3898	0x0F3A
Loop.16.Diag.SchedTi	3870	0x0F1E	Loop.16.PID.NumSets	3904	0x0F40
Loop.16.Diag.TargetOutVal	3955	0x0F73	Loop.16.PID.OutputHi	3881	0x0F29
Loop.16.Main.ActiveOut	3844	0x0F04	Loop.16.PID.OutputHi2	3891	0x0F33
Loop.16.Main.AutoMan	3850	0x0F0A	Loop.16.PID.OutputHi3	3901	0x0F3D
Loop.16.Main.Inhibit	3860	0x0F14	Loop.16.PID.OutputLo	3882	0x0F2A
Loop.16.Main.PV	3841	0x0F01	Loop.16.PID.OutputLo2	3892	0x0F34
Loop.16.Main.TargetSP	3842	0x0F02	Loop.16.PID.OutputLo3	3902	0x0F3E
Loop.16.Main.WorkingSP	3845	0x0F05	Loop.16.PID.ProportionalBand	3846	0x0F06
Loop.16.OP.Ch1OnOffHysteresis	3924	0x0F54	Loop.16.PID.ProportionalBand2	3883	0x0F2B
Loop.16.OP.Ch1Out	3922	0x0F52	Loop.16.PID.ProportionalBand3	3893	0x0F35
Loop.16.OP.Ch2Deadband	3856	0x0F10	Loop.16.PID.RelCh2Gain	3859	0x0F13
Loop.16.OP.Ch2OnOffHysteresis	3925	0x0F55	Loop.16.PID.RelCh2Gain2	3890	0x0F32
Loop.16.OP.Ch2Out	3923	0x0F53	Loop.16.PID.RelCh2Gain3	3900	0x0F3C
Loop.16.OP.CoolType	3933	0x0F5D	Loop.16.PID.SchedulerRemotelInput	3905	0x0F41
Loop.16.OP.EnablePowerFeedforward	3931	0x0F5B	Loop.16.PID.SchedulerType	3903	0x0F3F
Loop.16.OP.FeedForwardGain	3935	0x0F5F	Loop.16.Setup.CH1ControlType	3862	0x0F16
Loop.16.OP.FeedForwardOffset	3936	0x0F60	Loop.16.Setup.CH2ControlType	3863	0x0F17
Loop.16.OP.FeedForwardTrimLimit	3937	0x0F61	Loop.16.Setup.ControlAction	3847	0x0F07
Loop.16.OP.FeedForwardType	3934	0x0F5E	Loop.16.Setup.DerivativeType	3865	0x0F19
Loop.16.OP.FeedForwardVal	3938	0x0F62	Loop.16.Setup.LoopType	3861	0x0F15
Loop.16.OP.FF_Rem	3943	0x0F67	Loop.16.Setup.PBUnits	3864	0x0F18
Loop.16.OP.ManualMode	3930	0x0F5A	Loop.16.SP.AltSP	3908	0x0F44
Loop.16.OP.ManualOutVal	3843	0x0F03	Loop.16.SP.AltSPSelect	3909	0x0F45
Loop.16.OP.MeasuredPower	3932	0x0F5C	Loop.16.SP.ManualTrack	3915	0x0F4B
Loop.16.OP.OutputHighLimit	3920	0x0F50	Loop.16.SP.RangeHigh	3852	0x0F0C
Loop.16.OP.OutputLowLimit	3921	0x0F51	Loop.16.SP.RangeLow	3851	0x0F0B
Loop.16.OP.Rate	3926	0x0F56	Loop.16.SP.Rate	3910	0x0F46
Loop.16.OP.RateDisable	3927	0x0F57	Loop.16.SP.RateDisable	3911	0x0F47
Loop.16.OP.RemOPH	3942	0x0F66	Loop.16.SP.RateDone	3919	0x0F4F
Loop.16.OP.RemOPL	3941	0x0F65	Loop.16.SP.SP1	3853	0x0F0D
Loop.16.OP.SafeOutVal	3929	0x0F59	Loop.16.SP.SP2	3854	0x0F0E
Loop.16.OP.SBrkOP	3963	0x0F7B	Loop.16.SP.SPHighLimit	3906	0x0F42
Loop.16.OP.SensorBreakMode	3928	0x0F58	Loop.16.SP.SPLowLimit	3907	0x0F43
Loop.16.OP.TrackEnable	3940	0x0F64	Loop.16.SP.SPSelect	3855	0x0F0F
Loop.16.OP.TrackOutVal	3939	0x0F63	Loop.16.SP.SPTrack	3916	0x0F4C
Loop.16.PID.ActiveSet	3868	0x0F1C	Loop.16.SP.SPTrim	3912	0x0F48
Loop.16.PID.Boundary1-2	3866	0x0F1A	Loop.16.SP.SPTrimHighLimit	3913	0x0F49
Loop.16.PID.Boundary2-3	3867	0x0F1B	Loop.16.SP.SPTrimLowLimit	3914	0x0F4A
Loop.16.PID.CutbackHigh	3858	0x0F12	Loop.16.SP.TrackPV	3917	0x0F4D
Loop.16.PID.CutbackHigh2	3886	0x0F2E	Loop.16.SP.TrackSP	3918	0x0F4E

MINI8 CONTROLLER: ENGINEERING HANDBOOK

Parameter Description / Modbus address	DEC	HEX	Parameter Description / Modbus address	DEC	HEX
Loop.16.Tune.AutotuneEnable	3948	0x0F6C	Math2.16.Out	4797	0x12bd
Loop.16.Tune.OutputHighLimit	3945	0x0F69	Math2.17.In1	4798	0x12be
Loop.16.Tune.OutputLowLimit	3946	0x0F6A	Math2.17.In2	4799	0x12bf
Loop.16.Tune.Stage	3951	0x0F6F	Math2.17.Out	4800	0x12c0
Loop.16.Tune.StageTime	3952	0x0F70	Math2.18.In1	4801	0x12c1
Loop.16.Tune.State	3950	0x0F6E	Math2.18.In2	4802	0x12c2
Loop.16.Tune.StepSize	3949	0x0F6D	Math2.18.Out	4803	0x12c3
Loop.16.Tune.Type	3944	0x0F68	Math2.19.In1	4804	0x12c4
Math2.1.In1	4750	0x128e	Math2.19.In2	4805	0x12c5
Math2.1.In2	4751	0x128f	Math2.19.Out	4806	0x12c6
Math2.1.Out	4752	0x1290	Math2.20.In1	4807	0x12c7
Math2.2.In1	4753	0x1291	Math2.20.In2	4808	0x12c8
Math2.2.In2	4754	0x1292	Math2.20.Out	4809	0x12c9
Math2.2.Out	4755	0x1293	Math2.21.In1	4810	0x12ca
Math2.3.In1	4756	0x1294	Math2.21.In2	4811	0x12cb
Math2.3.In2	4757	0x1295	Math2.21.Out	4812	0x12cc
Math2.3.Out	4758	0x1296	Math2.22.In1	4813	0x12cd
Math2.4.In1	4759	0x1297	Math2.22.In2	4814	0x12ce
Math2.4.In2	4760	0x1298	Math2.22.Out	4815	0x12cf
Math2.4.Out	4761	0x1299	Math2.23.In1	4816	0x12d0
Math2.5.In1	4762	0x129a	Math2.23.In2	4817	0x12d1
Math2.5.In2	4763	0x129b	Math2.23.Out	4818	0x12d2
Math2.5.Out	4764	0x129c	Math2.24.In1	4819	0x12d3
Math2.6.In1	4765	0x129d	Math2.24.In2	4820	0x12d4
Math2.6.In2	4766	0x129e	Math2.24.Out	4821	0x12d5
Math2.6.Out	4767	0x129f	MultiOper.1.AverageOut	5017	0x1399
Math2.7.In1	4768	0x12a0	MultiOper.1.In1	5006	0x138e
Math2.7.In2	4769	0x12a1	MultiOper.1.In2	5007	0x138f
Math2.7.Out	4770	0x12a2	MultiOper.1.In3	5008	0x1390
Math2.8.In1	4771	0x12a3	MultiOper.1.In4	5009	0x1391
Math2.8.In2	4772	0x12a4	MultiOper.1.In5	5010	0x1392
Math2.8.Out	4773	0x12a5	MultiOper.1.In6	5011	0x1393
Math2.9.In1	4774	0x12a6	MultiOper.1.In7	5012	0x1394
Math2.9.In2	4775	0x12a7	MultiOper.1.In8	5013	0x1395
Math2.9.Out	4776	0x12a8	MultiOper.1.MaxOut	5015	0x1397
Math2.10.In1	4777	0x12a9	MultiOper.1.MinOut	5016	0x1398
Math2.10.In2	4778	0x12aa	MultiOper.1.SumOut	5014	0x1396
Math2.10.Out	4779	0x12ab	MultiOper.2.AverageOut	5029	0x13a5
Math2.11.In1	4780	0x12ac	MultiOper.2.In1	5018	0x139a
Math2.11.In2	4781	0x12ad	MultiOper.2.In2	5019	0x139b
Math2.11.Out	4782	0x12ae	MultiOper.2.In3	5020	0x139c
Math2.12.In1	4783	0x12af	MultiOper.2.In4	5021	0x139d
Math2.12.In2	4784	0x12b0	MultiOper.2.In5	5022	0x139e
Math2.12.Out	4785	0x12b1	MultiOper.2.In6	5023	0x139f
Math2.13.In1	4786	0x12b2	MultiOper.2.In7	5024	0x13a0
Math2.13.In2	4787	0x12b3	MultiOper.2.In8	5025	0x13a1
Math2.13.Out	4788	0x12b4	MultiOper.2.MaxOut	5027	0x13a3
Math2.14.In1	4789	0x12b5	MultiOper.2.MinOut	5028	0x13a4
Math2.14.In2	4790	0x12b6	MultiOper.2.SumOut	5026	0x13a2
Math2.14.Out	4791	0x12b7	MultiOper.3.AverageOut	5041	0x13b1
Math2.15.In1	4792	0x12b8	MultiOper.3.In1	5030	0x13a6
Math2.15.In2	4793	0x12b9	MultiOper.3.In2	5031	0x13a7
Math2.15.Out	4794	0x12ba	MultiOper.3.In3	5032	0x13a8
Math2.16.In1	4795	0x12bb	MultiOper.3.In4	5033	0x13a9
Math2.16.In2	4796	0x12bc	MultiOper.3.In5	5034	0x13aa

MINI8 CONTROLLER: ENGINEERING HANDBOOK

Parameter Description / Modbus address	DEC	HEX	Parameter Description / Modbus address	DEC	HEX
MultiOper.3.In6	5035	0x13ab	UsrVal.21.Val	4982	0x1376
MultiOper.3.In7	5036	0x13ac	UsrVal.22.Val	4983	0x1377
MultiOper.3.In8	5037	0x13ad	UsrVal.23.Val	4984	0x1378
MultiOper.3.MaxOut	5039	0x13af	UsrVal.24.Val	4985	0x1379
MultiOper.3.MinOut	5040	0x13b0	UsrVal.25.Val	4986	0x137a
MultiOper.3.SumOut	5038	0x13ae	UsrVal.26.Val	4987	0x137b
MultiOper.4.AverageOut	5053	0x13bd	UsrVal.27.Val	4988	0x137c
MultiOper.4.In1	5042	0x13b2	UsrVal.28.Val	4989	0x137d
MultiOper.4.In2	5043	0x13b3	UsrVal.29.Val	4990	0x137e
MultiOper.4.In3	5044	0x13b4	UsrVal.30.Val	4991	0x137f
MultiOper.4.In4	5045	0x13b5	UsrVal.31.Val	4992	0x1380
MultiOper.4.In5	5046	0x13b6	UsrVal.32.Val	4993	0x1381
MultiOper.4.In6	5047	0x13b7	Zirconia.1.CarbonPot	13256	0x33C8
MultiOper.4.In7	5048	0x13b8	Zirconia.1.CleanFreq	13251	0x33C3
MultiOper.4.In8	5049	0x13b9	Zirconia.1.CleanProbe	13248	0x33CO
MultiOper.4.MaxOut	5051	0x13bb	Zirconia.1.CleanState	13268	0x33D4
MultiOper.4.MinOut	5052	0x13bc	Zirconia.1.CleanTime	13252	0x33C4
MultiOper.4.SumOut	5050	0x13ba	Zirconia.1.CleanValve	13263	0x33CF
Recipe.LastDataset	4913	0x1331	Zirconia.1.DewPoint	13274	0x33DA
Recipe.LoadingStatus	4914	0x1332	Zirconia.1.GasRef	13254	0x33C6
Recipe.RecipeSelect	4912	0x1330	Zirconia.1.MaxRcovTime	13253	0x33C5
SwitchOver.SelectIn	4927	0x133f	Zirconia.1.MinCalTemp	13270	0x33D6
SwitchOver.SwitchHigh	4925	0x133d	Zirconia.1.MinRcovTime	13255	0x33C7
SwitchOver.SwitchLow	4926	0x133e	Zirconia.1.Oxygen	13261	0x33CD
Timer.1.ElapsedTime	4995	0x1383	Zirconia.1.OxygenExp	13260	0x33CC
Timer.1.Out	4996	0x1384	Zirconia.1.ProbeFault	13271	0x33D7
Timer.1.Time	4994	0x1382	Zirconia.1.ProbeInput	13259	0x33CB
Timer.2.ElapsedTime	4998	0x1386	Zirconia.1.ProbeOffset	13250	0x33C2
Timer.2.Out	4999	0x1387	Zirconia.1.ProbeStatus	13262	0x33CE
Timer.2.Time	4997	0x1385	Zirconia.1.ProbeType	13258	0x33CA
Timer.3.ElapsedTime	5001	0x1389	Zirconia.1.ProcFactor	13275	0x33DB
Timer.3.Out	5002	0x138A	Zirconia.1.PVFrozen	13272	0x33D8
Timer.3.Time	5000	0x1388	Zirconia.1.RemGasEn	13257	0x33C9
Timer.4.ElapsedTime	5004	0x138C	Zirconia.1.RemGasRef	13267	0x33D3
Timer.4.Out	5005	0x138D	Zirconia.1.Resolution	13273	0x33D9
Timer.4.Time	5003	0x138B	Zirconia.1.SootAlm	13264	0x33D0
UsrVal.1.Val	4962	0x1362	Zirconia.1.TempInput	13269	0x33D5
UsrVal.2.Val	4963	0x1363	Zirconia.1.TempOffset	13266	0x33D2
UsrVal.3.Val	4964	0x1364	Zirconia.1.Time2Clean	13249	0x33C1
UsrVal.4.Val	4965	0x1365	Zirconia.1.Tolerance	13276	0x33DC
UsrVal.5.Val	4966	0x1366	Zirconia.1.WrkGas	13265	0x33D1
UsrVal.6.Val	4967	0x1367	Zirconia.2.CarbonPot	13288	0x33E8
UsrVal.7.Val	4968	0x1368	Zirconia.2.CleanFreq	13283	0x33E3
UsrVal.8.Val	4969	0x1369	Zirconia.2.CleanProbe	13280	0x33EO
UsrVal.9.Val	4970	0x136a	Zirconia.2.CleanState	13300	0x33F4
UsrVal.10.Val	4971	0x136b	Zirconia.2.CleanTime	13284	0x33E4
UsrVal.11.Val	4972	0x136c	Zirconia.2.CleanValve	13295	0x33EF
UsrVal.12.Val	4973	0x136d	Zirconia.2.DewPoint	13306	0x33FA
UsrVal.13.Val	4974	0x136e	Zirconia.2.GasRef	13286	0x33E6
UsrVal.14.Val	4975	0x136f	Zirconia.2.MaxRcovTime	13285	0x33E5
UsrVal.15.Val	4976	0x1370	Zirconia.2.MinCalTemp	13302	0x33F6
UsrVal.16.Val	4977	0x1371	Zirconia.2.MinRcovTime	13287	0x33E7
UsrVal.17.Val	4978	0x1372	Zirconia.2.Oxygen	13293	0x33ED
UsrVal.18.Val	4979	0x1373	Zirconia.2.OxygenExp	13292	0x33EC
UsrVal.19.Val	4980	0x1374	Zirconia.2.ProbeFault	13303	0x33F7
UsrVal.20.Val	4981	0x1375	Zirconia.2.ProbeInput	13291	0x33EB

Parameter Description / Modbus address	DEC	HEX
Zirconia.2.ProbeOffset	13282	0x33E2
Zirconia.2.ProbeStatus	13294	0x33EE
Zirconia.2.ProbeType	13290	0x33EA
Zirconia.2.ProcFactor	13307	0x33FB
Zirconia.2.PVFrozen	13304	0x33F8
Zirconia.2.RemGasEn	13289	0x33E9
Zirconia.2.RemGasRef	13299	0x33F3
Zirconia.2.Resolution	13305	0x33F9
Zirconia.2.SootAlm	13296	0x33F0
Zirconia.2.TemplInput	13301	0x33F5
Zirconia.2.TempOffset	13298	0x33F2
Zirconia.2.Time2Clean	13281	0x33E1
Zirconia.2.Tolerance	13308	0x33FC
Zirconia.2.WrkGas	13297	0x33F1

24.2.1 Programmer Address Ranges - Decimal

The following table shows the addresses set aside for programmers.

PROGRAM NUMBER	DECIMAL ADDRESSES (2.xx)	1	2	3	4	5	6	7	8
Comms.n.ProgramNumber		5568	5632	5696	5760	5824	5888	5952	6016
Program.n.HoldbackVal		5569	5633	5697	5761	5825	5889	5953	6017
Program.n.RampUnits		5570	5634	5698	5762	5826	5890	5954	6018
Program.n.DwellUnits		5571	5635	5699	5763	5827	5891	5955	6019
Program.n.Cycles		5572	5636	5700	5764	5828	5892	5956	6020
Programmer.n.PowerFailAct		5573	5637	5701	5765	5829	5893	5957	6021
Programmer.n.Servo		5574	5638	5702	5766	5830	5894	5958	6022
Programmer.n.SyncMode		5575	5639	5703	5767	5831	5895	5959	6023
Programmer.n.ResetEventOuts		5576	5640	5704	5768	5832	5896	5960	6024
Programmer.n.CurProg		5577	5641	5705	5769	5833	5897	5961	6025
Programmer.n.CurSeg		5578	5642	5706	5770	5834	5898	5962	6026
Programmer.n.ProgStatus		5579	5643	5707	5771	5835	5899	5963	6027
Programmer.n.PSP		5580	5644	5708	5772	5836	5900	5964	6028
Programmer.n.CyclesLeft		5581	5645	5709	5773	5837	5901	5965	6029
Programmer.n.CurSegType		5582	5646	5710	5774	5838	5902	5966	6030
Programmer.n.SegTarget		5583	5647	5711	5775	5839	5903	5967	6031
Programmer.n.SegRate		5584	5648	5712	5776	5840	5904	5968	6032
Programmer.n.ProgTimeLeft		5585	5649	5713	5777	5841	5905	5969	6033
Programmer.n.PVIn		5586	5650	5714	5778	5842	5906	5970	6034
Programmer.n.SPln		5587	5651	5715	5779	5843	5907	5971	6035
Programmer.n.EventOuts		5588	5652	5716	5780	5844	5908	5972	6036
Programmer.n.SegTimeLeft		5589	5653	5717	5781	5845	5909	5973	6037
Programmer.n.EndOfSeg		5590	5654	5718	5782	5846	5910	5974	6038
Programmer.n.Syncln		5591	5655	5719	5783	5847	5911	5975	6039
Programmer.n.FastRun		5592	5656	5720	5784	5848	5912	5976	6040
Programmer.n.AdvSeg		5593	5657	5721	5785	5849	5913	5977	6041
Programmer.n.SkipSeg		5594	5658	5722	5786	5850	5914	5978	6042
Program.n.PVStart		5597	5661	5725	5789	5853	5917	5981	6045
Programmer.n.PrgIn1		5602	5666	5730	5794	5858	5922	5986	6050
Programmer.n.PrgIn2		5603	5667	5731	5795	5859	5923	5987	6051
Programmer.n.PVWaitIP		5604	5668	5732	5796	5860	5924	5988	6052
Programmer.n.ProgError		5605	5669	5733	5797	5861	5925	5989	6053
Programmer.n.PVEventOP		5606	5670	5734	5798	5862	5926	5990	6054
Programmer.n.GoBackCyclesLeft		5645	5709	5773	5837	5901	5965	6029	6093
Programmer.n.DelayTime		5685	5749	5813	5877	5941	6005	6069	6133
Programmer.n.ProgReset		5726	5790	5854	5918	5982	6046	6110	6174
Programmer.n.ProgRun		5768	5832	5896	5960	6024	6088	6152	6216
Programmer.n.ProgHold		5811	5875	5939	6003	6067	6131	6195	6259
Programmer.n.ProgRunHold		5855	5919	5983	6047	6111	6175	6239	6303
Programmer.n.ProgRunReset		5900	5964	6028	6092	6156	6220	6284	6348
Segment.1.Type		6080	6592	7104	7616	8128	8640	9152	9664
Segment.1.Holdback		6081	6593	7105	7617	8129	8641	9153	9665
Segment.1.Duration		6084	6596	7108	7620	8132	8644	9156	9668
Segment.1.RampRate		6085	6597	7109	7621	8133	8645	9157	9669
Segment.1.TargetSP		6086	6598	7110	7622	8134	8646	9158	9670
Segment.1.EndAction		6087	6599	7111	7623	8135	8647	9159	9671
Segment.1.EventOutputs		6088	6600	7112	7624	8136	8648	9160	9672
Segment.1.WaitFor		6089	6601	7113	7625	8137	8649	9161	9673
		6090	6602	7114	7626	8138	8650	9162	9674
Segment.1.PVEvent		6093	6605	7117	7629	8141	8653	9165	9677
Segment.1.PVThreshold		6094	6606	7118	7630	8142	8654	9166	9678
Segment.1.UserVal		6095	6607	7119	7631	8143	8655	9167	9679
Segment.1.GsoakType		6096	6608	7120	7632	8144	8656	9168	9680
Segment.1.GsoakVal		6097	6609	7121	7633	8145	8657	9169	9681
Segment.1.TimeEvent		6098	6610	7122	7634	8146	8658	9170	9682

MINI8 CONTROLLER: ENGINEERING HANDBOOK

PROGRAM NUMBER	DECIMAL ADDRESSES (2.xx)	1	2	3	4	5	6	7	8
Segment.1.OnTime		6099	6611	7123	7635	8147	8659	9171	9683
Segment.1.OffTime		6100	6612	7124	7636	8148	8660	9172	9684
Segment.1.PIDSet		6101	6613	7125	7637	8149	8661	9173	9685
Segment.1.PVWait		6102	6614	7126	7638	8150	8662	9174	9686
Segment.1.WaitVal		6103	6615	7127	7639	8151	8663	9175	9687
Segment.2.Type		6112	6624	7136	7648	8160	8672	9184	9696
Segment.2.Holdback		6113	6625	7137	7649	8161	8673	9185	9697
Segment.2.Duration		6116	6628	7140	7652	8164	8676	9188	9700
Segment.2.RampRate		6117	6629	7141	7653	8165	8677	9189	9701
Segment.2.TargetSP		6118	6630	7142	7654	8166	8678	9190	9702
Segment.2.EndAction		6119	6631	7143	7655	8167	8679	9191	9703
Segment.2.EventOutputs		6120	6632	7144	7656	8168	8680	9192	9704
Segment.2.WaitFor		6121	6633	7145	7657	8169	8681	9193	9705
		6122	6634	7146	7658	8170	8682	9194	9706
Segment.2.GobackSeg		6123	6635	7147	7659	8171	8683	9195	9707
Segment.2.GobackCycles		6124	6636	7148	7660	8172	8684	9196	9708
Segment.2.PVEvent		6125	6637	7149	7661	8173	8685	9197	9709
Segment.2.PVThreshold		6126	6638	7150	7662	8174	8686	9198	9710
Segment.2.UserVal		6127	6639	7151	7663	8175	8687	9199	9711
Segment.2.GsoakType		6128	6640	7152	7664	8176	8688	9200	9712
Segment.2.GsoakVal		6129	6641	7153	7665	8177	8689	9201	9713
Segment.2.TimeEvent		6130	6642	7154	7666	8178	8690	9202	9714
Segment.2.OnTime		6131	6643	7155	7667	8179	8691	9203	9715
Segment.2.OffTime		6132	6644	7156	7668	8180	8692	9204	9716
Segment.2.PIDSet		6133	6645	7157	7669	8181	8693	9205	9717
Segment.2.PVWait		6134	6646	7158	7670	8182	8694	9206	9718
Segment.2.WaitVal		6135	6647	7159	7671	8183	8695	9207	9719
Segment.3.Type		6144	6656	7168	7680	8192	8704	9216	9728
Segment.3.Holdback		6145	6657	7169	7681	8193	8705	9217	9729
Segment.3.Duration		6148	6660	7172	7684	8196	8708	9220	9732
Segment.3.RampRate		6149	6661	7173	7685	8197	8709	9221	9733
Segment.3.TargetSP		6150	6662	7174	7686	8198	8710	9222	9734
Segment.3.EndAction		6151	6663	7175	7687	8199	8711	9223	9735
Segment.3.EventOutputs		6152	6664	7176	7688	8200	8712	9224	9736
Segment.3.WaitFor		6153	6665	7177	7689	8201	8713	9225	9737
		6154	6666	7178	7690	8202	8714	9226	9738
Segment.3.GobackSeg		6155	6667	7179	7691	8203	8715	9227	9739
Segment.3.GobackCycles		6156	6668	7180	7692	8204	8716	9228	9740
Segment.3.PVEvent		6157	6669	7181	7693	8205	8717	9229	9741
Segment.3.PVThreshold		6158	6670	7182	7694	8206	8718	9230	9742
Segment.3.UserVal		6159	6671	7183	7695	8207	8719	9231	9743
Segment.3.GsoakType		6160	6672	7184	7696	8208	8720	9232	9744
Segment.3.GsoakVal		6161	6673	7185	7697	8209	8721	9233	9745
Segment.3.TimeEvent		6162	6674	7186	7698	8210	8722	9234	9746
Segment.3.OnTime		6163	6675	7187	7699	8211	8723	9235	9747
Segment.3.OffTime		6164	6676	7188	7700	8212	8724	9236	9748
Segment.3.PIDSet		6165	6677	7189	7701	8213	8725	9237	9749
Segment.3.PVWait		6166	6678	7190	7702	8214	8726	9238	9750
Segment.3.WaitVal		6167	6679	7191	7703	8215	8727	9239	9751
Segment.4.Type		6176	6688	7200	7712	8224	8736	9248	9760
Segment.4.Holdback		6177	6689	7201	7713	8225	8737	9249	9761
Segment.4.Duration		6180	6692	7204	7716	8228	8740	9252	9764
Segment.4.RampRate		6181	6693	7205	7717	8229	8741	9253	9765
Segment.4.TargetSP		6182	6694	7206	7718	8230	8742	9254	9766
Segment.4.EndAction		6183	6695	7207	7719	8231	8743	9255	9767
Segment.4.EventOutputs		6184	6696	7208	7720	8232	8744	9256	9768

MINI8 CONTROLLER: ENGINEERING HANDBOOK

PROGRAM NUMBER	DECIMAL ADDRESSES (2.xx)	1	2	3	4	5	6	7	8
Segment.4.WaitFor		6185	6697	7209	7721	8233	8745	9257	9769
		6186	6698	7210	7722	8234	8746	9258	9770
Segment.4.GobackSeg		6187	6699	7211	7723	8235	8747	9259	9771
Segment.4.GobackCycles		6188	6700	7212	7724	8236	8748	9260	9772
Segment.4.PVEvent		6189	6701	7213	7725	8237	8749	9261	9773
Segment.4.PVThreshold		6190	6702	7214	7726	8238	8750	9262	9774
Segment.4.UserVal		6191	6703	7215	7727	8239	8751	9263	9775
Segment.4.GsoakType		6192	6704	7216	7728	8240	8752	9264	9776
Segment.4.GsoakVal		6193	6705	7217	7729	8241	8753	9265	9777
Segment.4.TimeEvent		6194	6706	7218	7730	8242	8754	9266	9778
Segment.4.OnTime		6195	6707	7219	7731	8243	8755	9267	9779
Segment.4.OffTime		6196	6708	7220	7732	8244	8756	9268	9780
Segment.4.PIDSet		6197	6709	7221	7733	8245	8757	9269	9781
Segment.4.PVWait		6198	6710	7222	7734	8246	8758	9270	9782
Segment.4.WaitVal		6199	6711	7223	7735	8247	8759	9271	9783
Segment.5.Type		6208	6720	7232	7744	8256	8768	9280	9792
Segment.5.Holdback		6209	6721	7233	7745	8257	8769	9281	9793
Segment.5.Duration		6212	6724	7236	7748	8260	8772	9284	9796
Segment.5.RampRate		6213	6725	7237	7749	8261	8773	9285	9797
Segment.5.TargetSP		6214	6726	7238	7750	8262	8774	9286	9798
Segment.5.EndAction		6215	6727	7239	7751	8263	8775	9287	9799
Segment.5.EventOutputs		6216	6728	7240	7752	8264	8776	9288	9800
Segment.5.WaitFor		6217	6729	7241	7753	8265	8777	9289	9801
		6218	6730	7242	7754	8266	8778	9290	9802
Segment.5.GobackSeg		6219	6731	7243	7755	8267	8779	9291	9803
Segment.5.GobackCycles		6220	6732	7244	7756	8268	8780	9292	9804
Segment.5.PVEvent		6221	6733	7245	7757	8269	8781	9293	9805
Segment.5.PVThreshold		6222	6734	7246	7758	8270	8782	9294	9806
Segment.5.UserVal		6223	6735	7247	7759	8271	8783	9295	9807
Segment.5.GsoakType		6224	6736	7248	7760	8272	8784	9296	9808
Segment.5.GsoakVal		6225	6737	7249	7761	8273	8785	9297	9809
Segment.5.TimeEvent		6226	6738	7250	7762	8274	8786	9298	9810
Segment.5.OnTime		6227	6739	7251	7763	8275	8787	9299	9811
Segment.5.OffTime		6228	6740	7252	7764	8276	8788	9300	9812
Segment.5.PIDSet		6229	6741	7253	7765	8277	8789	9301	9813
Segment.5.PVWait		6230	6742	7254	7766	8278	8790	9302	9814
Segment.5.WaitVal		6231	6743	7255	7767	8279	8791	9303	9815
Segment.6.Type		6240	6752	7264	7776	8288	8800	9312	9824
Segment.6.Holdback		6241	6753	7265	7777	8289	8801	9313	9825
Segment.6.Duration		6244	6756	7268	7780	8292	8804	9316	9828
Segment.6.RampRate		6245	6757	7269	7781	8293	8805	9317	9829
Segment.6.TargetSP		6246	6758	7270	7782	8294	8806	9318	9830
Segment.6.EndAction		6247	6759	7271	7783	8295	8807	9319	9831
Segment.6.EventOutputs		6248	6760	7272	7784	8296	8808	9320	9832
Segment.6.WaitFor		6249	6761	7273	7785	8297	8809	9321	9833
		6250	6762	7274	7786	8298	8810	9322	9834
Segment.6.GobackSeg		6251	6763	7275	7787	8299	8811	9323	9835
Segment.6.GobackCycles		6252	6764	7276	7788	8300	8812	9324	9836
Segment.6.PVEvent		6253	6765	7277	7789	8301	8813	9325	9837
Segment.6.PVThreshold		6254	6766	7278	7790	8302	8814	9326	9838
Segment.6.UserVal		6255	6767	7279	7791	8303	8815	9327	9839
Segment.6.GsoakType		6256	6768	7280	7792	8304	8816	9328	9840
Segment.6.GsoakVal		6257	6769	7281	7793	8305	8817	9329	9841
Segment.6.TimeEvent		6258	6770	7282	7794	8306	8818	9330	9842
Segment.6.OnTime		6259	6771	7283	7795	8307	8819	9331	9843
Segment.6.OffTime		6260	6772	7284	7796	8308	8820	9332	9844
Segment.6.PIDSet		6261	6773	7285	7797	8309	8821	9333	9845

MINI8 CONTROLLER: ENGINEERING HANDBOOK

PROGRAM NUMBER	DECIMAL ADDRESSES (2.xx)	1	2	3	4	5	6	7	8
Segment.6.PVWait		6262	6774	7286	7798	8310	8822	9334	9846
Segment.6.WaitVal		6263	6775	7287	7799	8311	8823	9335	9847
Segment.7.Type		6272	6784	7296	7808	8320	8832	9344	9856
Segment.7.Holdback		6273	6785	7297	7809	8321	8833	9345	9857
Segment.7.Duration		6276	6788	7300	7812	8324	8836	9348	9860
Segment.7.RampRate		6277	6789	7301	7813	8325	8837	9349	9861
Segment.7.TargetSP		6278	6790	7302	7814	8326	8838	9350	9862
Segment.7.EndAction		6279	6791	7303	7815	8327	8839	9351	9863
Segment.7.EventOutputs		6280	6792	7304	7816	8328	8840	9352	9864
Segment.7.WaitFor		6281	6793	7305	7817	8329	8841	9353	9865
		6282	6794	7306	7818	8330	8842	9354	9866
Segment.7.GobackSeg		6283	6795	7307	7819	8331	8843	9355	9867
Segment.7.GobackCycles		6284	6796	7308	7820	8332	8844	9356	9868
Segment.7.PVEvent		6285	6797	7309	7821	8333	8845	9357	9869
Segment.7.PVThreshold		6286	6798	7310	7822	8334	8846	9358	9870
Segment.7.UserVal		6287	6799	7311	7823	8335	8847	9359	9871
Segment.7.GsoakType		6288	6800	7312	7824	8336	8848	9360	9872
Segment.7.GsoakVal		6289	6801	7313	7825	8337	8849	9361	9873
Segment.7.TimeEvent		6290	6802	7314	7826	8338	8850	9362	9874
Segment.7.OnTime		6291	6803	7315	7827	8339	8851	9363	9875
Segment.7.OffTime		6292	6804	7316	7828	8340	8852	9364	9876
Segment.7.PIDSet		6293	6805	7317	7829	8341	8853	9365	9877
Segment.7.PVWait		6294	6806	7318	7830	8342	8854	9366	9878
Segment.7.WaitVal		6295	6807	7319	7831	8343	8855	9367	9879
Segment.8.Type		6304	6816	7328	7840	8352	8864	9376	9888
Segment.8.Holdback		6305	6817	7329	7841	8353	8865	9377	9889
Segment.8.Duration		6308	6820	7332	7844	8356	8868	9380	9892
Segment.8.RampRate		6309	6821	7333	7845	8357	8869	9381	9893
Segment.8.TargetSP		6310	6822	7334	7846	8358	8870	9382	9894
Segment.8.EndAction		6311	6823	7335	7847	8359	8871	9383	9895
Segment.8.EventOutputs		6312	6824	7336	7848	8360	8872	9384	9896
Segment.8.WaitFor		6313	6825	7337	7849	8361	8873	9385	9897
		6314	6826	7338	7850	8362	8874	9386	9898
Segment.8.GobackSeg		6315	6827	7339	7851	8363	8875	9387	9899
Segment.8.GobackCycles		6316	6828	7340	7852	8364	8876	9388	9900
Segment.8.PVEvent		6317	6829	7341	7853	8365	8877	9389	9901
Segment.8.PVThreshold		6318	6830	7342	7854	8366	8878	9390	9902
Segment.8.UserVal		6319	6831	7343	7855	8367	8879	9391	9903
Segment.8.GsoakType		6320	6832	7344	7856	8368	8880	9392	9904
Segment.8.GsoakVal		6321	6833	7345	7857	8369	8881	9393	9905
Segment.8.TimeEvent		6322	6834	7346	7858	8370	8882	9394	9906
Segment.8.OnTime		6323	6835	7347	7859	8371	8883	9395	9907
Segment.8.OffTime		6324	6836	7348	7860	8372	8884	9396	9908
Segment.8.PIDSet		6325	6837	7349	7861	8373	8885	9397	9909
Segment.8.PVWait		6326	6838	7350	7862	8374	8886	9398	9910
Segment.8.WaitVal		6327	6839	7351	7863	8375	8887	9399	9911
Segment.9.Type		6336	6848	7360	7872	8384	8896	9408	9920
Segment.9.Holdback		6337	6849	7361	7873	8385	8897	9409	9921
Segment.9.Duration		6340	6852	7364	7876	8388	8900	9412	9924
Segment.9.RampRate		6341	6853	7365	7877	8389	8901	9413	9925
Segment.9.TargetSP		6342	6854	7366	7878	8390	8902	9414	9926
Segment.9.EndAction		6343	6855	7367	7879	8391	8903	9415	9927
Segment.9.EventOutputs		6344	6856	7368	7880	8392	8904	9416	9928
Segment.9.WaitFor		6345	6857	7369	7881	8393	8905	9417	9929
		6346	6858	7370	7882	8394	8906	9418	9930
Segment.9.GobackSeg		6347	6859	7371	7883	8395	8907	9419	9931

MINI8 CONTROLLER: ENGINEERING HANDBOOK

PROGRAM NUMBER	DECIMAL ADDRESSES (2.xx)	1	2	3	4	5	6	7	8
Segment.9.GobackCycles		6348	6860	7372	7884	8396	8908	9420	9932
Segment.9.PVEvent		6349	6861	7373	7885	8397	8909	9421	9933
Segment.9.PVThreshold		6350	6862	7374	7886	8398	8910	9422	9934
Segment.9.UserVal		6351	6863	7375	7887	8399	8911	9423	9935
Segment.9.GsoakType		6352	6864	7376	7888	8400	8912	9424	9936
Segment.9.GsoakVal		6353	6865	7377	7889	8401	8913	9425	9937
Segment.9.TimeEvent		6354	6866	7378	7890	8402	8914	9426	9938
Segment.9.OnTime		6355	6867	7379	7891	8403	8915	9427	9939
Segment.9.OffTime		6356	6868	7380	7892	8404	8916	9428	9940
Segment.9.PIDSet		6357	6869	7381	7893	8405	8917	9429	9941
Segment.9.PVWait		6358	6870	7382	7894	8406	8918	9430	9942
Segment.9.WaitVal		6359	6871	7383	7895	8407	8919	9431	9943
Segment.10.Type		6368	6880	7392	7904	8416	8928	9440	9952
Segment.10.Holdback		6369	6881	7393	7905	8417	8929	9441	9953
Segment.10.Duration		6372	6884	7396	7908	8420	8932	9444	9956
Segment.10.RampRate		6373	6885	7397	7909	8421	8933	9445	9957
Segment.10.TargetSP		6374	6886	7398	7910	8422	8934	9446	9958
Segment.10.EndAction		6375	6887	7399	7911	8423	8935	9447	9959
Segment.10.EventOutputs		6376	6888	7400	7912	8424	8936	9448	9960
Segment.10.WaitFor		6377	6889	7401	7913	8425	8937	9449	9961
		6378	6890	7402	7914	8426	8938	9450	9962
Segment.10.GobackSeg		6379	6891	7403	7915	8427	8939	9451	9963
Segment.10.GobackCycles		6380	6892	7404	7916	8428	8940	9452	9964
Segment.10.PVEvent		6381	6893	7405	7917	8429	8941	9453	9965
Segment.10.PVThreshold		6382	6894	7406	7918	8430	8942	9454	9966
Segment.10.UserVal		6383	6895	7407	7919	8431	8943	9455	9967
Segment.10.GsoakType		6384	6896	7408	7920	8432	8944	9456	9968
Segment.10.GsoakVal		6385	6897	7409	7921	8433	8945	9457	9969
Segment.10.TimeEvent		6386	6898	7410	7922	8434	8946	9458	9970
Segment.10.OnTime		6387	6899	7411	7923	8435	8947	9459	9971
Segment.10.OffTime		6388	6900	7412	7924	8436	8948	9460	9972
Segment.10.PIDSet		6389	6901	7413	7925	8437	8949	9461	9973
Segment.10.PVWait		6390	6902	7414	7926	8438	8950	9462	9974
Segment.10.WaitVal		6391	6903	7415	7927	8439	8951	9463	9975
Segment.11.Type		6400	6912	7424	7936	8448	8960	9472	9984
Segment.11.Holdback		6401	6913	7425	7937	8449	8961	9473	9985
Segment.11.Duration		6404	6916	7428	7940	8452	8964	9476	9988
Segment.11.RampRate		6405	6917	7429	7941	8453	8965	9477	9989
Segment.11.TargetSP		6406	6918	7430	7942	8454	8966	9478	9990
Segment.11.EndAction		6407	6919	7431	7943	8455	8967	9479	9991
Segment.11.EventOutputs		6408	6920	7432	7944	8456	8968	9480	9992
Segment.11.WaitFor		6409	6921	7433	7945	8457	8969	9481	9993
		6410	6922	7434	7946	8458	8970	9482	9994
Segment.11.GobackSeg		6411	6923	7435	7947	8459	8971	9483	9995
Segment.11.GobackCycles		6412	6924	7436	7948	8460	8972	9484	9996
Segment.11.PVEvent		6413	6925	7437	7949	8461	8973	9485	9997
Segment.11.PVThreshold		6414	6926	7438	7950	8462	8974	9486	9998
Segment.11.UserVal		6415	6927	7439	7951	8463	8975	9487	9999
Segment.11.GsoakType		6416	6928	7440	7952	8464	8976	9488	10000
Segment.11.GsoakVal		6417	6929	7441	7953	8465	8977	9489	10001
Segment.11.TimeEvent		6418	6930	7442	7954	8466	8978	9490	10002
Segment.11.OnTime		6419	6931	7443	7955	8467	8979	9491	10003
Segment.11.OffTime		6420	6932	7444	7956	8468	8980	9492	10004
Segment.11.PIDSet		6421	6933	7445	7957	8469	8981	9493	10005
Segment.11.PVWait		6422	6934	7446	7958	8470	8982	9494	10006
Segment.11.WaitVal		6423	6935	7447	7959	8471	8983	9495	10007
Segment.12.Type		6432	6944	7456	7968	8480	8992	9504	10016

MINI8 CONTROLLER: ENGINEERING HANDBOOK

PROGRAM NUMBER	DECIMAL ADDRESSES (2.xx)	1	2	3	4	5	6	7	8
Segment.12.Holdback		6433	6945	7457	7969	8481	8993	9505	10017
Segment.12.Duration		6436	6948	7460	7972	8484	8996	9508	10020
Segment.12.RampRate		6437	6949	7461	7973	8485	8997	9509	10021
Segment.12.TargetSP		6438	6950	7462	7974	8486	8998	9510	10022
Segment.12.EndAction		6439	6951	7463	7975	8487	8999	9511	10023
Segment.12.EventOutputs		6440	6952	7464	7976	8488	9000	9512	10024
Segment.12.WaitFor		6441	6953	7465	7977	8489	9001	9513	10025
		6442	6954	7466	7978	8490	9002	9514	10026
Segment.12.GobackSeg		6443	6955	7467	7979	8491	9003	9515	10027
Segment.12.GobackCycles		6444	6956	7468	7980	8492	9004	9516	10028
Segment.12.PVEvent		6445	6957	7469	7981	8493	9005	9517	10029
Segment.12.PVThreshold		6446	6958	7470	7982	8494	9006	9518	10030
Segment.12.UserVal		6447	6959	7471	7983	8495	9007	9519	10031
Segment.12.GsoakType		6448	6960	7472	7984	8496	9008	9520	10032
Segment.12.GsoakVal		6449	6961	7473	7985	8497	9009	9521	10033
Segment.12.TimeEvent		6450	6962	7474	7986	8498	9010	9522	10034
Segment.12.OnTime		6451	6963	7475	7987	8499	9011	9523	10035
Segment.12.OffTime		6452	6964	7476	7988	8500	9012	9524	10036
Segment.12.PIDSet		6453	6965	7477	7989	8501	9013	9525	10037
Segment.12.PVWait		6454	6966	7478	7990	8502	9014	9526	10038
Segment.12.WaitVal		6455	6967	7479	7991	8503	9015	9527	10039
Segment.13.Type		6464	6976	7488	8000	8512	9024	9536	10048
Segment.13.Holdback		6465	6977	7489	8001	8513	9025	9537	10049
Segment.13.Duration		6468	6980	7492	8004	8516	9028	9540	10052
Segment.13.RampRate		6469	6981	7493	8005	8517	9029	9541	10053
Segment.13.TargetSP		6470	6982	7494	8006	8518	9030	9542	10054
Segment.13.EndAction		6471	6983	7495	8007	8519	9031	9543	10055
Segment.13.EventOutputs		6472	6984	7496	8008	8520	9032	9544	10056
Segment.13.WaitFor		6473	6985	7497	8009	8521	9033	9545	10057
		6474	6986	7498	8010	8522	9034	9546	10058
Segment.13.GobackSeg		6475	6987	7499	8011	8523	9035	9547	10059
Segment.13.GobackCycles		6476	6988	7500	8012	8524	9036	9548	10060
Segment.13.PVEvent		6477	6989	7501	8013	8525	9037	9549	10061
Segment.13.PVThreshold		6478	6990	7502	8014	8526	9038	9550	10062
Segment.13.UserVal		6479	6991	7503	8015	8527	9039	9551	10063
Segment.13.GsoakType		6480	6992	7504	8016	8528	9040	9552	10064
Segment.13.GsoakVal		6481	6993	7505	8017	8529	9041	9553	10065
Segment.13.TimeEvent		6482	6994	7506	8018	8530	9042	9554	10066
Segment.13.OnTime		6483	6995	7507	8019	8531	9043	9555	10067
Segment.13.OffTime		6484	6996	7508	8020	8532	9044	9556	10068
Segment.13.PIDSet		6485	6997	7509	8021	8533	9045	9557	10069
Segment.13.PVWait		6486	6998	7510	8022	8534	9046	9558	10070
Segment.13.WaitVal		6487	6999	7511	8023	8535	9047	9559	10071
Segment.14.Type		6496	7008	7520	8032	8544	9056	9568	10080
Segment.14.Holdback		6497	7009	7521	8033	8545	9057	9569	10081
Segment.14.Duration		6500	7012	7524	8036	8548	9060	9572	10084
Segment.14.RampRate		6501	7013	7525	8037	8549	9061	9573	10085
Segment.14.TargetSP		6502	7014	7526	8038	8550	9062	9574	10086
Segment.14.EndAction		6503	7015	7527	8039	8551	9063	9575	10087
Segment.14.EventOutputs		6504	7016	7528	8040	8552	9064	9576	10088
Segment.14.WaitFor		6505	7017	7529	8041	8553	9065	9577	10089
		6506	7018	7530	8042	8554	9066	9578	10090
Segment.14.GobackSeg		6507	7019	7531	8043	8555	9067	9579	10091
Segment.14.GobackCycles		6508	7020	7532	8044	8556	9068	9580	10092
Segment.14.PVEvent		6509	7021	7533	8045	8557	9069	9581	10093
Segment.14.PVThreshold		6510	7022	7534	8046	8558	9070	9582	10094

MINI8 CONTROLLER: ENGINEERING HANDBOOK

PROGRAM NUMBER	DECIMAL ADDRESSES (2.xx)	1	2	3	4	5	6	7	8
Segment.14.UserVal		6511	7023	7535	8047	8559	9071	9583	10095
Segment.14.GsoakType		6512	7024	7536	8048	8560	9072	9584	10096
Segment.14.GsoakVal		6513	7025	7537	8049	8561	9073	9585	10097
Segment.14.TimeEvent		6514	7026	7538	8050	8562	9074	9586	10098
Segment.14.OnTime		6515	7027	7539	8051	8563	9075	9587	10099
Segment.14.OffTime		6516	7028	7540	8052	8564	9076	9588	10100
Segment.14.PIDSet		6517	7029	7541	8053	8565	9077	9589	10101
Segment.14.PVWait		6518	7030	7542	8054	8566	9078	9590	10102
Segment.14.WaitVal		6519	7031	7543	8055	8567	9079	9591	10103
Segment.15.Type		6528	7040	7552	8064	8576	9088	9600	10112
Segment.15.Holdback		6529	7041	7553	8065	8577	9089	9601	10113
Segment.15.Duration		6532	7044	7556	8068	8580	9092	9604	10116
Segment.15.RampRate		6533	7045	7557	8069	8581	9093	9605	10117
Segment.15.TargetSP		6534	7046	7558	8070	8582	9094	9606	10118
Segment.15.EndAction		6535	7047	7559	8071	8583	9095	9607	10119
Segment.15.EventOutputs		6536	7048	7560	8072	8584	9096	9608	10120
Segment.15.WaitFor		6537	7049	7561	8073	8585	9097	9609	10121
		6538	7050	7562	8074	8586	9098	9610	10122
Segment.15.GobackSeg		6539	7051	7563	8075	8587	9099	9611	10123
Segment.15.GobackCycles		6540	7052	7564	8076	8588	9100	9612	10124
Segment.15.PVEvent		6541	7053	7565	8077	8589	9101	9613	10125
Segment.15.PVThreshold		6542	7054	7566	8078	8590	9102	9614	10126
Segment.15.UserVal		6543	7055	7567	8079	8591	9103	9615	10127
Segment.15.GsoakType		6544	7056	7568	8080	8592	9104	9616	10128
Segment.15.GsoakVal		6545	7057	7569	8081	8593	9105	9617	10129
Segment.15.TimeEvent		6546	7058	7570	8082	8594	9106	9618	10130
Segment.15.OnTime		6547	7059	7571	8083	8595	9107	9619	10131
Segment.15.OffTime		6548	7060	7572	8084	8596	9108	9620	10132
Segment.15.PIDSet		6549	7061	7573	8085	8597	9109	9621	10133
Segment.15.PVWait		6550	7062	7574	8086	8598	9110	9622	10134
Segment.15.WaitVal		6551	7063	7575	8087	8599	9111	9623	10135
Segment.16.Type		6560	7072	7584	8096	8608	9120	9632	10144
Segment.16.Holdback		6561	7073	7585	8097	8609	9121	9633	10145
Segment.16.Duration		6564	7076	7588	8100	8612	9124	9636	10148
Segment.16.RampRate		6565	7077	7589	8101	8613	9125	9637	10149
Segment.16.TargetSP		6566	7078	7590	8102	8614	9126	9638	10150
Segment.16.EndAction		6567	7079	7591	8103	8615	9127	9639	10151
Segment.16.EventOutputs		6568	7080	7592	8104	8616	9128	9640	10152
Segment.16.WaitFor		6569	7081	7593	8105	8617	9129	9641	10153
		6570	7082	7594	8106	8618	9130	9642	10154
Segment.16.GobackSeg		6571	7083	7595	8107	8619	9131	9643	10155
Segment.16.GobackCycles		6572	7084	7596	8108	8620	9132	9644	10156
Segment.16.PVEvent		6573	7085	7597	8109	8621	9133	9645	10157
Segment.16.PVThreshold		6574	7086	7598	8110	8622	9134	9646	10158
Segment.16.UserVal		6575	7087	7599	8111	8623	9135	9647	10159
Segment.16.GsoakType		6576	7088	7600	8112	8624	9136	9648	10160
Segment.16.GsoakVal		6577	7089	7601	8113	8625	9137	9649	10161
Segment.16.TimeEvent		6578	7090	7602	8114	8626	9138	9650	10162
Segment.16.OnTime		6579	7091	7603	8115	8627	9139	9651	10163
Segment.16.OffTime		6580	7092	7604	8116	8628	9140	9652	10164
Segment.16.PIDSet		6581	7093	7605	8117	8629	9141	9653	10165
Segment.16.PVWait		6582	7094	7606	8118	8630	9142	9654	10166
Segment.16.WaitVal		6583	7095	7607	8119	8631	9143	9655	10167

24.2.2 Version 2.xx Programmer Addresses - Hexadecimal

PROGRAM NUMBER HEXADECIMAL ADDRESS (2.xx)	1	2	3	4	5	6	7	8
Comms.n.ProgramNumber	15C0	1600	1640	1680	16C0	1700	1740	1780
Program.n.HoldbackVal	15C1	1601	1641	1681	16C1	1701	1741	1781
Program.n.RampUnits	15C2	1602	1642	1682	16C2	1702	1742	1782
Program.n.DwellUnits	15C3	1603	1643	1683	16C3	1703	1743	1783
Program.n.Cycles	15C4	1604	1644	1684	16C4	1704	1744	1784
Programmer.n.PowerFailAct	15C5	1605	1645	1685	16C5	1705	1745	1785
Programmer.n.Servo	15C6	1606	1646	1686	16C6	1706	1746	1786
Programmer.n.SyncMode	15C7	1607	1647	1687	16C7	1707	1747	1787
Programmer.n.ResetEventOuts	15C8	1608	1648	1688	16C8	1708	1748	1788
Programmer.n.CurProg	15C9	1609	1649	1689	16C9	1709	1749	1789
Programmer.n.CurSeg	15CA	160A	164A	168A	16CA	170A	174A	178A
Programmer.n.ProgStatus	15CB	160B	164B	168B	16CB	170B	174B	178B
Programmer.n.PSP	15CC	160C	164C	168C	16CC	170C	174C	178C
Programmer.n.CyclesLeft	15CD	160D	164D	168D	16CD	170D	174D	178D
Programmer.n.CurSegType	15CE	160E	164E	168E	16CE	170E	174E	178E
Programmer.n.SegTarget	15CF	160F	164F	168F	16CF	170F	174F	178F
Programmer.n.SegRate	15D0	1610	1650	1690	16D0	1710	1750	1790
Programmer.n.ProgTimeLeft	15D1	1611	1651	1691	16D1	1711	1751	1791
Programmer.n.PVIn	15D2	1612	1652	1692	16D2	1712	1752	1792
Programmer.n.SPIIn	15D3	1613	1653	1693	16D3	1713	1753	1793
Programmer.n.EventOuts	15D4	1614	1654	1694	16D4	1714	1754	1794
Programmer.n.SegTimeLeft	15D5	1615	1655	1695	16D5	1715	1755	1795
Programmer.n.EndOfSeg	15D6	1616	1656	1696	16D6	1716	1756	1796
Programmer.n.SyncIn	15D7	1617	1657	1697	16D7	1717	1757	1797
Programmer.n.FastRun	15D8	1618	1658	1698	16D8	1718	1758	1798
Programmer.n.AdvSeg	15D9	1619	1659	1699	16D9	1719	1759	1799
Programmer.n.SkipSeg	15DA	161A	165A	169A	16DA	171A	175A	179A
Program.n.PVStart	15DD	161D	165D	169D	16DD	171D	175D	179D
Programmer.n.PrgIn1	15E2	1622	1662	16A2	16E2	1722	1762	17A2
Programmer.n.PrgIn2	15E3	1623	1663	16A3	16E3	1723	1763	17A3
Programmer.n.PVWaitIP	15E4	1624	1664	16A4	16E4	1724	1764	17A4
Programmer.n.ProgError	15E5	1625	1665	16A5	16E5	1725	1765	17A5
Programmer.n.PVEventOP	15E6	1626	1666	16A6	16E6	1726	1766	17A6
Programmer.n.GoBackCyclesLeft	160D	164D	168D	16CD	170D	174D	178D	17CD
Programmer.n.DelayTime	1635	1675	16B5	16F5	1735	1775	17B5	17F5
Programmer.n.ProgReset	165E	169E	16DE	171E	175E	179E	17DE	181E
Programmer.n.ProgRun	1688	16C8	1708	1748	1788	17C8	1808	1848
Programmer.n.ProgHold	16B3	16F3	1733	1773	17B3	17F3	1833	1873
Programmer.n.ProgRunHold	16DF	171F	175F	179F	17DF	181F	185F	189F
Programmer.n.ProgRunReset	170C	174C	178C	17CC	180C	184C	188C	18CC
Segment.1.Type	17C0	19C0	1BC0	1DC0	1FC0	21C0	23C0	25C0
Segment.1.Holdback	17C1	19C1	1BC1	1DC1	1FC1	21C1	23C1	25C1
Segment.1.CallProgNum	17C2	19C2	1BC2	1DC2	1FC2	21C2	23C2	25C2
Segment.1.Cycles	17C3	19C3	1BC3	1DC3	1FC3	21C3	23C3	25C3
Segment.1.Duration	17C4	19C4	1BC4	1DC4	1FC4	21C4	23C4	25C4
Segment.1.RampRate	17C5	19C5	1BC5	1DC5	1FC5	21C5	23C5	25C5
Segment.1.TargetSP	17C6	19C6	1BC6	1DC6	1FC6	21C6	23C6	25C6
Segment.1.EndAction	17C7	19C7	1BC7	1DC7	1FC7	21C7	23C7	25C7
Segment.1.EventOutputs	17C8	19C8	1BC8	1DC8	1FC8	21C8	23C8	25C8
Segment.1.WaitFor	17C9	19C9	1BC9	1DC9	1FC9	21C9	23C9	25C9
	17CA	19CA	1BCA	1DCA	1FCA	21CA	23CA	25CA
Segment.1.PVEvent	17CD	19CD	1BCD	1DCD	1FCD	21CD	23CD	25CD
Segment.1.PVThreshold	17CE	19CE	1BCE	1DCE	1FCE	21CE	23CE	25CE
Segment.1.UserVal	17CF	19CF	1BCF	1DCF	1FCF	21CF	23CF	25CF
Segment.1.GsoakType	17D0	19D0	1BD0	1DD0	1FD0	21D0	23D0	25D0

MINI8 CONTROLLER: ENGINEERING HANDBOOK

PROGRAM NUMBER	HEXADECIMAL ADDRESS (2.xx)	1	2	3	4	5	6	7	8
Segment.1.GsoakVal		17D1	19D1	1BD1	1DD1	1FD1	21D1	23D1	25D1
Segment.1.TimeEvent		17D2	19D2	1BD2	1DD2	1FD2	21D2	23D2	25D2
Segment.1.OnTime		17D3	19D3	1BD3	1DD3	1FD3	21D3	23D3	25D3
Segment.1.OffTime		17D4	19D4	1BD4	1DD4	1FD4	21D4	23D4	25D4
Segment.1.PIDSet		17D5	19D5	1BD5	1DD5	1FD5	21D5	23D5	25D5
Segment.1.PVWait		17D6	19D6	1BD6	1DD6	1FD6	21D6	23D6	25D6
Segment.1.WaitVal		17D7	19D7	1BD7	1DD7	1FD7	21D7	23D7	25D7
Segment.2.Type		17E0	19E0	1BE0	1DE0	1FE0	21E0	23E0	25E0
Segment.2.Holdback		17E1	19E1	1BE1	1DE1	1FE1	21E1	23E1	25E1
Segment.2.Duration		17E4	19E4	1BE4	1DE4	1FE4	21E4	23E4	25E4
Segment.2.RampRate		17E5	19E5	1BE5	1DE5	1FE5	21E5	23E5	25E5
Segment.2.TargetSP		17E6	19E6	1BE6	1DE6	1FE6	21E6	23E6	25E6
Segment.2.EndAction		17E7	19E7	1BE7	1DE7	1FE7	21E7	23E7	25E7
Segment.2.EventOutputs		17E8	19E8	1BE8	1DE8	1FE8	21E8	23E8	25E8
Segment.2.WaitFor		17E9	19E9	1BE9	1DE9	1FE9	21E9	23E9	25E9
		17EA	19EA	1BEA	1DEA	1FEA	21EA	23EA	25EA
Segment.2.GobackSeg		17EB	19EB	1BEB	1DEB	1FEB	21EB	23EB	25EB
Segment.2.GobackCycles		17EC	19EC	1BEC	1DEC	1FEC	21EC	23EC	25EC
Segment.2.PVEvent		17ED	19ED	1BED	1DED	1FED	21ED	23ED	25ED
Segment.2.PVThreshold		17EE	19EE	1BEE	1DEE	1FEE	21EE	23EE	25EE
Segment.2.UserVal		17EF	19EF	1BEF	1DEF	1FEF	21EF	23EF	25EF
Segment.2.GsoakType		17F0	19F0	1BF0	1DF0	1FF0	21F0	23F0	25F0
Segment.2.GsoakVal		17F1	19F1	1BF1	1DF1	1FF1	21F1	23F1	25F1
Segment.2.TimeEvent		17F2	19F2	1BF2	1DF2	1FF2	21F2	23F2	25F2
Segment.2.OnTime		17F3	19F3	1BF3	1DF3	1FF3	21F3	23F3	25F3
Segment.2.OffTime		17F4	19F4	1BF4	1DF4	1FF4	21F4	23F4	25F4
Segment.2.PIDSet		17F5	19F5	1BF5	1DF5	1FF5	21F5	23F5	25F5
Segment.2.PVWait		17F6	19F6	1BF6	1DF6	1FF6	21F6	23F6	25F6
Segment.2.WaitVal		17F7	19F7	1BF7	1DF7	1FF7	21F7	23F7	25F7
Segment.3.Type		1800	1A00	1C00	1E00	2000	2200	2400	2600
Segment.3.Holdback		1801	1A01	1C01	1E01	2001	2201	2401	2601
Segment.3.Duration		1804	1A04	1C04	1E04	2004	2204	2404	2604
Segment.3.RampRate		1805	1A05	1C05	1E05	2005	2205	2405	2605
Segment.3.TargetSP		1806	1A06	1C06	1E06	2006	2206	2406	2606
Segment.3.EndAction		1807	1A07	1C07	1E07	2007	2207	2407	2607
Segment.3.EventOutputs		1808	1A08	1C08	1E08	2008	2208	2408	2608
Segment.3.WaitFor		1809	1A09	1C09	1E09	2009	2209	2409	2609
		180A	1A0A	1C0A	1E0A	200A	220A	240A	260A
Segment.3.GobackSeg		180B	1A0B	1C0B	1E0B	200B	220B	240B	260B
Segment.3.GobackCycles		180C	1A0C	1C0C	1E0C	200C	220C	240C	260C
Segment.3.PVEvent		180D	1A0D	1C0D	1E0D	200D	220D	240D	260D
Segment.3.PVThreshold		180E	1A0E	1C0E	1E0E	200E	220E	240E	260E
Segment.3.UserVal		180F	1A0F	1C0F	1E0F	200F	220F	240F	260F
Segment.3.GsoakType		1810	1A10	1C10	1E10	2010	2210	2410	2610
Segment.3.GsoakVal		1811	1A11	1C11	1E11	2011	2211	2411	2611
Segment.3.TimeEvent		1812	1A12	1C12	1E12	2012	2212	2412	2612
Segment.3.OnTime		1813	1A13	1C13	1E13	2013	2213	2413	2613
Segment.3.OffTime		1814	1A14	1C14	1E14	2014	2214	2414	2614
Segment.3.PIDSet		1815	1A15	1C15	1E15	2015	2215	2415	2615
Segment.3.PVWait		1816	1A16	1C16	1E16	2016	2216	2416	2616
Segment.3.WaitVal		1817	1A17	1C17	1E17	2017	2217	2417	2617
Segment.4.Type		1820	1A20	1C20	1E20	2020	2220	2420	2620
Segment.4.Holdback		1821	1A21	1C21	1E21	2021	2221	2421	2621
Segment.4.Duration		1824	1A24	1C24	1E24	2024	2224	2424	2624
Segment.4.RampRate		1825	1A25	1C25	1E25	2025	2225	2425	2625
Segment.4.TargetSP		1826	1A26	1C26	1E26	2026	2226	2426	2626
Segment.4.EndAction		1827	1A27	1C27	1E27	2027	2227	2427	2627

MINI8 CONTROLLER: ENGINEERING HANDBOOK

PROGRAM NUMBER HEXADECIMAL ADDRESS (2.xx)	1	2	3	4	5	6	7	8
Segment.4.EventOutputs	1828	1A28	1C28	1E28	2028	2228	2428	2628
Segment.4.WaitFor	1829	1A29	1C29	1E29	2029	2229	2429	2629
	182A	1A2A	1C2A	1E2A	202A	222A	242A	262A
Segment.4.GobackSeg	182B	1A2B	1C2B	1E2B	202B	222B	242B	262B
Segment.4.GobackCycles	182C	1A2C	1C2C	1E2C	202C	222C	242C	262C
Segment.4.PVEvent	182D	1A2D	1C2D	1E2D	202D	222D	242D	262D
Segment.4.PVThreshold	182E	1A2E	1C2E	1E2E	202E	222E	242E	262E
Segment.4.UserVal	182F	1A2F	1C2F	1E2F	202F	222F	242F	262F
Segment.4.GsoakType	1830	1A30	1C30	1E30	2030	2230	2430	2630
Segment.4.GsoakVal	1831	1A31	1C31	1E31	2031	2231	2431	2631
Segment.4.TimeEvent	1832	1A32	1C32	1E32	2032	2232	2432	2632
Segment.4.OnTime	1833	1A33	1C33	1E33	2033	2233	2433	2633
Segment.4.OffTime	1834	1A34	1C34	1E34	2034	2234	2434	2634
Segment.4.PIDSet	1835	1A35	1C35	1E35	2035	2235	2435	2635
Segment.4.PVWait	1836	1A36	1C36	1E36	2036	2236	2436	2636
Segment.4.WaitVal	1837	1A37	1C37	1E37	2037	2237	2437	2637
Segment.5.Type	1840	1A40	1C40	1E40	2040	2240	2440	2640
Segment.5.Holdback	1841	1A41	1C41	1E41	2041	2241	2441	2641
Segment.5.Duration	1844	1A44	1C44	1E44	2044	2244	2444	2644
Segment.5.RampRate	1845	1A45	1C45	1E45	2045	2245	2445	2645
Segment.5.TargetSP	1846	1A46	1C46	1E46	2046	2246	2446	2646
Segment.5.EndAction	1847	1A47	1C47	1E47	2047	2247	2447	2647
Segment.5.EventOutputs	1848	1A48	1C48	1E48	2048	2248	2448	2648
Segment.5.WaitFor	1849	1A49	1C49	1E49	2049	2249	2449	2649
	184A	1A4A	1C4A	1E4A	204A	224A	244A	264A
Segment.5.GobackSeg	184B	1A4B	1C4B	1E4B	204B	224B	244B	264B
Segment.5.GobackCycles	184C	1A4C	1C4C	1E4C	204C	224C	244C	264C
Segment.5.PVEvent	184D	1A4D	1C4D	1E4D	204D	224D	244D	264D
Segment.5.PVThreshold	184E	1A4E	1C4E	1E4E	204E	224E	244E	264E
Segment.5.UserVal	184F	1A4F	1C4F	1E4F	204F	224F	244F	264F
Segment.5.GsoakType	1850	1A50	1C50	1E50	2050	2250	2450	2650
Segment.5.GsoakVal	1851	1A51	1C51	1E51	2051	2251	2451	2651
Segment.5.TimeEvent	1852	1A52	1C52	1E52	2052	2252	2452	2652
Segment.5.OnTime	1853	1A53	1C53	1E53	2053	2253	2453	2653
Segment.5.OffTime	1854	1A54	1C54	1E54	2054	2254	2454	2654
Segment.5.PIDSet	1855	1A55	1C55	1E55	2055	2255	2455	2655
Segment.5.PVWait	1856	1A56	1C56	1E56	2056	2256	2456	2656
Segment.5.WaitVal	1857	1A57	1C57	1E57	2057	2257	2457	2657
Segment.6.Type	1860	1A60	1C60	1E60	2060	2260	2460	2660
Segment.6.Holdback	1861	1A61	1C61	1E61	2061	2261	2461	2661
Segment.6.Duration	1864	1A64	1C64	1E64	2064	2264	2464	2664
Segment.6.RampRate	1865	1A65	1C65	1E65	2065	2265	2465	2665
Segment.6.TargetSP	1866	1A66	1C66	1E66	2066	2266	2466	2666
Segment.6.EndAction	1867	1A67	1C67	1E67	2067	2267	2467	2667
Segment.6.EventOutputs	1868	1A68	1C68	1E68	2068	2268	2468	2668
Segment.6.WaitFor	1869	1A69	1C69	1E69	2069	2269	2469	2669
	186A	1A6A	1C6A	1E6A	206A	226A	246A	266A
Segment.6.GobackSeg	186B	1A6B	1C6B	1E6B	206B	226B	246B	266B
Segment.6.GobackCycles	186C	1A6C	1C6C	1E6C	206C	226C	246C	266C
Segment.6.PVEvent	186D	1A6D	1C6D	1E6D	206D	226D	246D	266D
Segment.6.PVThreshold	186E	1A6E	1C6E	1E6E	206E	226E	246E	266E
Segment.6.UserVal	186F	1A6F	1C6F	1E6F	206F	226F	246F	266F
Segment.6.GsoakType	1870	1A70	1C70	1E70	2070	2270	2470	2670
Segment.6.GsoakVal	1871	1A71	1C71	1E71	2071	2271	2471	2671
Segment.6.TimeEvent	1872	1A72	1C72	1E72	2072	2272	2472	2672
Segment.6.OnTime	1873	1A73	1C73	1E73	2073	2273	2473	2673

MINI8 CONTROLLER: ENGINEERING HANDBOOK

PROGRAM NUMBER	HEXADECIMAL ADDRESS (2.xx)	1	2	3	4	5	6	7	8
Segment.6.OffTime		1874	1A74	1C74	1E74	2074	2274	2474	2674
Segment.6.PIDSet		1875	1A75	1C75	1E75	2075	2275	2475	2675
Segment.6.PVWait		1876	1A76	1C76	1E76	2076	2276	2476	2676
Segment.6.WaitVal		1877	1A77	1C77	1E77	2077	2277	2477	2677
Segment.7.Type		1880	1A80	1C80	1E80	2080	2280	2480	2680
Segment.7.Holdback		1881	1A81	1C81	1E81	2081	2281	2481	2681
Segment.7.Duration		1884	1A84	1C84	1E84	2084	2284	2484	2684
Segment.7.RampRate		1885	1A85	1C85	1E85	2085	2285	2485	2685
Segment.7.TargetSP		1886	1A86	1C86	1E86	2086	2286	2486	2686
Segment.7.EndAction		1887	1A87	1C87	1E87	2087	2287	2487	2687
Segment.7.EventOutputs		1888	1A88	1C88	1E88	2088	2288	2488	2688
Segment.7.WaitFor		1889	1A89	1C89	1E89	2089	2289	2489	2689
		188A	1A8A	1C8A	1E8A	208A	228A	248A	268A
Segment.7.GobackSeg		188B	1A8B	1C8B	1E8B	208B	228B	248B	268B
Segment.7.GobackCycles		188C	1A8C	1C8C	1E8C	208C	228C	248C	268C
Segment.7.PVEvent		188D	1A8D	1C8D	1E8D	208D	228D	248D	268D
Segment.7.PVThreshold		188E	1A8E	1C8E	1E8E	208E	228E	248E	268E
Segment.7.UserVal		188F	1A8F	1C8F	1E8F	208F	228F	248F	268F
Segment.7.GsoakType		1890	1A90	1C90	1E90	2090	2290	2490	2690
Segment.7.GsoakVal		1891	1A91	1C91	1E91	2091	2291	2491	2691
Segment.7.TimeEvent		1892	1A92	1C92	1E92	2092	2292	2492	2692
Segment.7.OnTime		1893	1A93	1C93	1E93	2093	2293	2493	2693
Segment.7.OffTime		1894	1A94	1C94	1E94	2094	2294	2494	2694
Segment.7.PIDSet		1895	1A95	1C95	1E95	2095	2295	2495	2695
Segment.7.PVWait		1896	1A96	1C96	1E96	2096	2296	2496	2696
Segment.7.WaitVal		1897	1A97	1C97	1E97	2097	2297	2497	2697
Segment.8.Type		18A0	1AA0	1CA0	1EA0	20A0	22A0	24A0	26A0
Segment.8.Holdback		18A1	1AA1	1CA1	1EA1	20A1	22A1	24A1	26A1
Segment.8.Duration		18A4	1AA4	1CA4	1EA4	20A4	22A4	24A4	26A4
Segment.8.RampRate		18A5	1AA5	1CA5	1EA5	20A5	22A5	24A5	26A5
Segment.8.TargetSP		18A6	1AA6	1CA6	1EA6	20A6	22A6	24A6	26A6
Segment.8.EndAction		18A7	1AA7	1CA7	1EA7	20A7	22A7	24A7	26A7
Segment.8.EventOutputs		18A8	1AA8	1CA8	1EA8	20A8	22A8	24A8	26A8
Segment.8.WaitFor		18A9	1AA9	1CA9	1EA9	20A9	22A9	24A9	26A9
		18AA	1AAA	1CAA	1EAA	20AA	22AA	24AA	26AA
Segment.8.GobackSeg		18AB	1AAB	1CAB	1EAB	20AB	22AB	24AB	26AB
Segment.8.GobackCycles		18AC	1AAC	1CAC	1EAC	20AC	22AC	24AC	26AC
Segment.8.PVEvent		18AD	1AAD	1CAD	1EAD	20AD	22AD	24AD	26AD
Segment.8.PVThreshold		18AE	1AAE	1CAE	1EAE	20AE	22AE	24AE	26AE
Segment.8.UserVal		18AF	1AAF	1CAF	1EAF	20AF	22AF	24AF	26AF
Segment.8.GsoakType		18B0	1AB0	1CB0	1EB0	20B0	22B0	24B0	26B0
Segment.8.GsoakVal		18B1	1AB1	1CB1	1EB1	20B1	22B1	24B1	26B1
Segment.8.TimeEvent		18B2	1AB2	1CB2	1EB2	20B2	22B2	24B2	26B2
Segment.8.OnTime		18B3	1AB3	1CB3	1EB3	20B3	22B3	24B3	26B3
Segment.8.OffTime		18B4	1AB4	1CB4	1EB4	20B4	22B4	24B4	26B4
Segment.8.PIDSet		18B5	1AB5	1CB5	1EB5	20B5	22B5	24B5	26B5
Segment.8.PVWait		18B6	1AB6	1CB6	1EB6	20B6	22B6	24B6	26B6
Segment.8.WaitVal		18B7	1AB7	1CB7	1EB7	20B7	22B7	24B7	26B7
Segment.9.Type		18C0	1AC0	1CC0	1EC0	20C0	22C0	24C0	26C0
Segment.9.Holdback		18C1	1AC1	1CC1	1EC1	20C1	22C1	24C1	26C1
Segment.9.Duration		18C4	1AC4	1CC4	1EC4	20C4	22C4	24C4	26C4
Segment.9.RampRate		18C5	1AC5	1CC5	1EC5	20C5	22C5	24C5	26C5
Segment.9.TargetSP		18C6	1AC6	1CC6	1EC6	20C6	22C6	24C6	26C6
Segment.9.EndAction		18C7	1AC7	1CC7	1EC7	20C7	22C7	24C7	26C7
Segment.9.EventOutputs		18C8	1AC8	1CC8	1EC8	20C8	22C8	24C8	26C8
Segment.9.WaitFor		18C9	1AC9	1CC9	1EC9	20C9	22C9	24C9	26C9
		18CA	1ACA	1CCA	1ECA	20CA	22CA	24CA	26CA

MINI8 CONTROLLER: ENGINEERING HANDBOOK

PROGRAM NUMBER HEXADECIMAL ADDRESS (2.xx)	1	2	3	4	5	6	7	8
Segment.9.GobackSeg	18CB	1ACB	1CCB	1ECB	20CB	22CB	24CB	26CB
Segment.9.GobackCycles	18CC	1ACC	1CCC	1ECC	20CC	22CC	24CC	26CC
Segment.9.PVEvent	18CD	1ACD	1CCD	1ECD	20CD	22CD	24CD	26CD
Segment.9.PVThreshold	18CE	1ACE	1CCE	1ECE	20CE	22CE	24CE	26CE
Segment.9.UserVal	18CF	1ACF	1CCF	1ECF	20CF	22CF	24CF	26CF
Segment.9.GsoakType	18D0	1AD0	1CD0	1ED0	20D0	22D0	24D0	26D0
Segment.9.GsoakVal	18D1	1AD1	1CD1	1ED1	20D1	22D1	24D1	26D1
Segment.9.TimeEvent	18D2	1AD2	1CD2	1ED2	20D2	22D2	24D2	26D2
Segment.9.OnTime	18D3	1AD3	1CD3	1ED3	20D3	22D3	24D3	26D3
Segment.9.OffTime	18D4	1AD4	1CD4	1ED4	20D4	22D4	24D4	26D4
Segment.9.PIDSet	18D5	1AD5	1CD5	1ED5	20D5	22D5	24D5	26D5
Segment.9.PVWait	18D6	1AD6	1CD6	1ED6	20D6	22D6	24D6	26D6
Segment.9.WaitVal	18D7	1AD7	1CD7	1ED7	20D7	22D7	24D7	26D7
Segment.10.Type	18E0	1AE0	1CE0	1EE0	20E0	22E0	24E0	26E0
Segment.10.Holdback	18E1	1AE1	1CE1	1EE1	20E1	22E1	24E1	26E1
Segment.10.Duration	18E4	1AE4	1CE4	1EE4	20E4	22E4	24E4	26E4
Segment.10.RampRate	18E5	1AE5	1CE5	1EE5	20E5	22E5	24E5	26E5
Segment.10.TargetSP	18E6	1AE6	1CE6	1EE6	20E6	22E6	24E6	26E6
Segment.10.EndAction	18E7	1AE7	1CE7	1EE7	20E7	22E7	24E7	26E7
Segment.10.EventOutputs	18E8	1AE8	1CE8	1EE8	20E8	22E8	24E8	26E8
Segment.10.WaitFor	18E9	1AE9	1CE9	1EE9	20E9	22E9	24E9	26E9
	18EA	1AEA	1CEA	1EEA	20EA	22EA	24EA	26EA
Segment.10.GobackSeg	18EB	1AEB	1CEB	1EEB	20EB	22EB	24EB	26EB
Segment.10.GobackCycles	18EC	1AEC	1CEC	1EEC	20EC	22EC	24EC	26EC
Segment.10.PVEvent	18ED	1AED	1CED	1EED	20ED	22ED	24ED	26ED
Segment.10.PVThreshold	18EE	1AEE	1CEE	1EEE	20EE	22EE	24EE	26EE
Segment.10.UserVal	18EF	1AEF	1CEF	1EEF	20EF	22EF	24EF	26EF
Segment.10.GsoakType	18F0	1AF0	1CF0	1EF0	20F0	22F0	24F0	26F0
Segment.10.GsoakVal	18F1	1AF1	1CF1	1EF1	20F1	22F1	24F1	26F1
Segment.10.TimeEvent	18F2	1AF2	1CF2	1EF2	20F2	22F2	24F2	26F2
Segment.10.OnTime	18F3	1AF3	1CF3	1EF3	20F3	22F3	24F3	26F3
Segment.10.OffTime	18F4	1AF4	1CF4	1EF4	20F4	22F4	24F4	26F4
Segment.10.PIDSet	18F5	1AF5	1CF5	1EF5	20F5	22F5	24F5	26F5
Segment.10.PVWait	18F6	1AF6	1CF6	1EF6	20F6	22F6	24F6	26F6
Segment.10.WaitVal	18F7	1AF7	1CF7	1EF7	20F7	22F7	24F7	26F7
Segment.11.Type	1900	1B00	1D00	1F00	2100	2300	2500	2700
Segment.11.Holdback	1901	1B01	1D01	1F01	2101	2301	2501	2701
Segment.11.Duration	1904	1B04	1D04	1F04	2104	2304	2504	2704
Segment.11.RampRate	1905	1B05	1D05	1F05	2105	2305	2505	2705
Segment.11.TargetSP	1906	1B06	1D06	1F06	2106	2306	2506	2706
Segment.11.EndAction	1907	1B07	1D07	1F07	2107	2307	2507	2707
Segment.11.EventOutputs	1908	1B08	1D08	1F08	2108	2308	2508	2708
Segment.11.WaitFor	1909	1B09	1D09	1F09	2109	2309	2509	2709
	190A	1B0A	1D0A	1F0A	210A	230A	250A	270A
Segment.11.GobackSeg	190B	1B0B	1D0B	1F0B	210B	230B	250B	270B
Segment.11.GobackCycles	190C	1B0C	1D0C	1F0C	210C	230C	250C	270C
Segment.11.PVEvent	190D	1B0D	1D0D	1F0D	210D	230D	250D	270D
Segment.11.PVThreshold	190E	1B0E	1D0E	1F0E	210E	230E	250E	270E
Segment.11.UserVal	190F	1B0F	1D0F	1F0F	210F	230F	250F	270F
Segment.11.GsoakType	1910	1B10	1D10	1F10	2110	2310	2510	2710
Segment.11.GsoakVal	1911	1B11	1D11	1F11	2111	2311	2511	2711
Segment.11.TimeEvent	1912	1B12	1D12	1F12	2112	2312	2512	2712
Segment.11.OnTime	1913	1B13	1D13	1F13	2113	2313	2513	2713
Segment.11.OffTime	1914	1B14	1D14	1F14	2114	2314	2514	2714
Segment.11.PIDSet	1915	1B15	1D15	1F15	2115	2315	2515	2715
Segment.11.PVWait	1916	1B16	1D16	1F16	2116	2316	2516	2716

MINI8 CONTROLLER: ENGINEERING HANDBOOK

PROGRAM NUMBER	HEXADECIMAL ADDRESS (2.xx)	1	2	3	4	5	6	7	8
Segment.11.WaitVal		1917	1B17	1D17	1F17	2117	2317	2517	2717
Segment.12.Type		1920	1B20	1D20	1F20	2120	2320	2520	2720
Segment.12.Holdback		1921	1B21	1D21	1F21	2121	2321	2521	2721
Segment.12.Duration		1924	1B24	1D24	1F24	2124	2324	2524	2724
Segment.12.RampRate		1925	1B25	1D25	1F25	2125	2325	2525	2725
Segment.12.TargetSP		1926	1B26	1D26	1F26	2126	2326	2526	2726
Segment.12.EndAction		1927	1B27	1D27	1F27	2127	2327	2527	2727
Segment.12.EventOutputs		1928	1B28	1D28	1F28	2128	2328	2528	2728
Segment.12.WaitFor		1929	1B29	1D29	1F29	2129	2329	2529	2729
		192A	1B2A	1D2A	1F2A	212A	232A	252A	272A
Segment.12.GobackSeg		192B	1B2B	1D2B	1F2B	212B	232B	252B	272B
Segment.12.GobackCycles		192C	1B2C	1D2C	1F2C	212C	232C	252C	272C
Segment.12.PVEvent		192D	1B2D	1D2D	1F2D	212D	232D	252D	272D
Segment.12.PVThreshold		192E	1B2E	1D2E	1F2E	212E	232E	252E	272E
Segment.12.UserVal		192F	1B2F	1D2F	1F2F	212F	232F	252F	272F
Segment.12.GsoakType		1930	1B30	1D30	1F30	2130	2330	2530	2730
Segment.12.GsoakVal		1931	1B31	1D31	1F31	2131	2331	2531	2731
Segment.12.TimeEvent		1932	1B32	1D32	1F32	2132	2332	2532	2732
Segment.12.OnTime		1933	1B33	1D33	1F33	2133	2333	2533	2733
Segment.12.OffTime		1934	1B34	1D34	1F34	2134	2334	2534	2734
Segment.12.PIDSet		1935	1B35	1D35	1F35	2135	2335	2535	2735
Segment.12.PVWait		1936	1B36	1D36	1F36	2136	2336	2536	2736
Segment.12.WaitVal		1937	1B37	1D37	1F37	2137	2337	2537	2737
Segment.13.Type		1940	1B40	1D40	1F40	2140	2340	2540	2740
Segment.13.Holdback		1941	1B41	1D41	1F41	2141	2341	2541	2741
Segment.13.Duration		1944	1B44	1D44	1F44	2144	2344	2544	2744
Segment.13.RampRate		1945	1B45	1D45	1F45	2145	2345	2545	2745
Segment.13.TargetSP		1946	1B46	1D46	1F46	2146	2346	2546	2746
Segment.13.EndAction		1947	1B47	1D47	1F47	2147	2347	2547	2747
Segment.13.EventOutputs		1948	1B48	1D48	1F48	2148	2348	2548	2748
Segment.13.WaitFor		1949	1B49	1D49	1F49	2149	2349	2549	2749
		194A	1B4A	1D4A	1F4A	214A	234A	254A	274A
Segment.13.GobackSeg		194B	1B4B	1D4B	1F4B	214B	234B	254B	274B
Segment.13.GobackCycles		194C	1B4C	1D4C	1F4C	214C	234C	254C	274C
Segment.13.PVEvent		194D	1B4D	1D4D	1F4D	214D	234D	254D	274D
Segment.13.PVThreshold		194E	1B4E	1D4E	1F4E	214E	234E	254E	274E
Segment.13.UserVal		194F	1B4F	1D4F	1F4F	214F	234F	254F	274F
Segment.13.GsoakType		1950	1B50	1D50	1F50	2150	2350	2550	2750
Segment.13.GsoakVal		1951	1B51	1D51	1F51	2151	2351	2551	2751
Segment.13.TimeEvent		1952	1B52	1D52	1F52	2152	2352	2552	2752
Segment.13.OnTime		1953	1B53	1D53	1F53	2153	2353	2553	2753
Segment.13.OffTime		1954	1B54	1D54	1F54	2154	2354	2554	2754
Segment.13.PIDSet		1955	1B55	1D55	1F55	2155	2355	2555	2755
Segment.13.PVWait		1956	1B56	1D56	1F56	2156	2356	2556	2756
Segment.13.WaitVal		1957	1B57	1D57	1F57	2157	2357	2557	2757
Segment.14.Type		1960	1B60	1D60	1F60	2160	2360	2560	2760
Segment.14.Holdback		1961	1B61	1D61	1F61	2161	2361	2561	2761
Segment.14.Duration		1964	1B64	1D64	1F64	2164	2364	2564	2764
Segment.14.RampRate		1965	1B65	1D65	1F65	2165	2365	2565	2765
Segment.14.TargetSP		1966	1B66	1D66	1F66	2166	2366	2566	2766
Segment.14.EndAction		1967	1B67	1D67	1F67	2167	2367	2567	2767
Segment.14.EventOutputs		1968	1B68	1D68	1F68	2168	2368	2568	2768
Segment.14.WaitFor		1969	1B69	1D69	1F69	2169	2369	2569	2769
		196A	1B6A	1D6A	1F6A	216A	236A	256A	276A
Segment.14.GobackSeg		196B	1B6B	1D6B	1F6B	216B	236B	256B	276B
Segment.14.GobackCycles		196C	1B6C	1D6C	1F6C	216C	236C	256C	276C
Segment.14.PVEvent		196D	1B6D	1D6D	1F6D	216D	236D	256D	276D

MINI8 CONTROLLER: ENGINEERING HANDBOOK

PROGRAM NUMBER HEXADECIMAL ADDRESS (2.xx)	1	2	3	4	5	6	7	8
Segment.14.PVThreshold	196E	1B6E	1D6E	1F6E	216E	236E	256E	276E
Segment.14.UserVal	196F	1B6F	1D6F	1F6F	216F	236F	256F	276F
Segment.14.GsoakType	1970	1B70	1D70	1F70	2170	2370	2570	2770
Segment.14.GsoakVal	1971	1B71	1D71	1F71	2171	2371	2571	2771
Segment.14.TimeEvent	1972	1B72	1D72	1F72	2172	2372	2572	2772
Segment.14.OnTime	1973	1B73	1D73	1F73	2173	2373	2573	2773
Segment.14.OffTime	1974	1B74	1D74	1F74	2174	2374	2574	2774
Segment.14.PIDSet	1975	1B75	1D75	1F75	2175	2375	2575	2775
Segment.14.PVWait	1976	1B76	1D76	1F76	2176	2376	2576	2776
Segment.14.WaitVal	1977	1B77	1D77	1F77	2177	2377	2577	2777
Segment.15.Type	1980	1B80	1D80	1F80	2180	2380	2580	2780
Segment.15.Holdback	1981	1B81	1D81	1F81	2181	2381	2581	2781
Segment.15.Duration	1984	1B84	1D84	1F84	2184	2384	2584	2784
Segment.15.RampRate	1985	1B85	1D85	1F85	2185	2385	2585	2785
Segment.15.TargetSP	1986	1B86	1D86	1F86	2186	2386	2586	2786
Segment.15.EndAction	1987	1B87	1D87	1F87	2187	2387	2587	2787
Segment.15.EventOutputs	1988	1B88	1D88	1F88	2188	2388	2588	2788
Segment.15.WaitFor	1989	1B89	1D89	1F89	2189	2389	2589	2789
	198A	1B8A	1D8A	1F8A	218A	238A	258A	278A
Segment.15.GobackSeg	198B	1B8B	1D8B	1F8B	218B	238B	258B	278B
Segment.15.GobackCycles	198C	1B8C	1D8C	1F8C	218C	238C	258C	278C
Segment.15.PVEvent	198D	1B8D	1D8D	1F8D	218D	238D	258D	278D
Segment.15.PVThreshold	198E	1B8E	1D8E	1F8E	218E	238E	258E	278E
Segment.15.UserVal	198F	1B8F	1D8F	1F8F	218F	238F	258F	278F
Segment.15.GsoakType	1990	1B90	1D90	1F90	2190	2390	2590	2790
Segment.15.GsoakVal	1991	1B91	1D91	1F91	2191	2391	2591	2791
Segment.15.TimeEvent	1992	1B92	1D92	1F92	2192	2392	2592	2792
Segment.15.OnTime	1993	1B93	1D93	1F93	2193	2393	2593	2793
Segment.15.OffTime	1994	1B94	1D94	1F94	2194	2394	2594	2794
Segment.15.PIDSet	1995	1B95	1D95	1F95	2195	2395	2595	2795
Segment.15.PVWait	1996	1B96	1D96	1F96	2196	2396	2596	2796
Segment.15.WaitVal	1997	1B97	1D97	1F97	2197	2397	2597	2797
Segment.16.Type	19A0	1BA0	1DA0	1FA0	21A0	23A0	25A0	27A0
Segment.16.Holdback	19A1	1BA1	1DA1	1FA1	21A1	23A1	25A1	27A1
Segment.16.Duration	19A4	1BA4	1DA4	1FA4	21A4	23A4	25A4	27A4
Segment.16.RampRate	19A5	1BA5	1DA5	1FA5	21A5	23A5	25A5	27A5
Segment.16.TargetSP	19A6	1BA6	1DA6	1FA6	21A6	23A6	25A6	27A6
Segment.16.EndAction	19A7	1BA7	1DA7	1FA7	21A7	23A7	25A7	27A7
Segment.16.EventOutputs	19A8	1BA8	1DA8	1FA8	21A8	23A8	25A8	27A8
Segment.16.WaitFor	19A9	1BA9	1DA9	1FA9	21A9	23A9	25A9	27A9
	19AA	1BAA	1DAA	1FAA	21AA	23AA	25AA	27AA
Segment.16.GobackSeg	19AB	1BAB	1DAB	1FAB	21AB	23AB	25AB	27AB
Segment.16.GobackCycles	19AC	1BAC	1DAC	1FAC	21AC	23AC	25AC	27AC
Segment.16.PVEvent	19AD	1BAD	1DAD	1FAD	21AD	23AD	25AD	27AD
Segment.16.PVThreshold	19AE	1BAE	1DAE	1FAE	21AE	23AE	25AE	27AE
Segment.16.UserVal	19AF	1BAF	1DAF	1FAF	21AF	23AF	25AF	27AF
Segment.16.GsoakType	19B0	1BB0	1DB0	1FB0	21B0	23B0	25B0	27B0
Segment.16.GsoakVal	19B1	1BB1	1DB1	1FB1	21B1	23B1	25B1	27B1
Segment.16.TimeEvent	19B2	1BB2	1DB2	1FB2	21B2	23B2	25B2	27B2
Segment.16.OnTime	19B3	1BB3	1DB3	1FB3	21B3	23B3	25B3	27B3
Segment.16.OffTime	19B4	1BB4	1DB4	1FB4	21B4	23B4	25B4	27B4
Segment.16.PIDSet	19B5	1BB5	1DB5	1FB5	21B5	23B5	25B5	27B5
Segment.16.PVWait	19B6	1BB6	1DB6	1FB6	21B6	23B6	25B6	27B6
Segment.16.WaitVal	19B7	1BB7	1DB7	1FB7	21B7	23B7	25B7	27B7

25. Appendix B DeviceNet PARAMETER TABLES

25.1 IO Re-Mapping Object

DeviceNet comes pre-configured with the key parameters of 8 PID loops and alarms (60 input parameters process variables, alarm status etc and 60 output parameters – setpoints etc.). Loops 9-16 are not included in the DeviceNet tables as there are insufficient attributes for the DeviceNet parameters

The Mini8 controller DeviceNet communicates is supplied with a default input assembly table (80 bytes) and output assembly table (48 bytes). The parameters included are listed below.

To modify these tables see the next section.

The default **Input** assembly table:-

Input Parameter	Offset	Value (Attr ID)
PV - Loop 1	0	0
Working SP - Loop 1	2	1
Working Output - Loop 1	4	2
PV - Loop 2	6	14 (0EH)
Working SP - Loop 2	8	15 (0FH)
Working Output - Loop 2	10	16 (10H)
PV - Loop 3	12	28 (1CH)
Working SP - Loop 3	14	29 (1DH)
Working Output - Loop 3	16	30 (1EH)
PV - Loop 4	18	42 (2AH)
Working SP - Loop 4	20	43 (2BH)
Working Output - Loop 4	22	44 (2CH)
PV - Loop 5	24	56 (38H)
Working SP - Loop 5	26	57 (39H)
Working Output - Loop 5	28	58 (3AH)
PV - Loop 6	30	70 (46H)
Working SP - Loop 6	32	71 (47H)
Working Output - Loop 6	34	72 (48H)
PV - Loop 7	36	84 (54H)
Working SP - Loop 7	38	85 (55H)
Working Output - Loop 7	40	86 (56H)
PV - Loop 8	42	98 (62H)
Working SP - Loop 8	44	99 (63H)
Working Output - Loop 8	46	100 (64H)
Analogue Alarm Status 1	48	144 (90H)
Analogue Alarm Status 2	50	145 (91H)
Analogue Alarm Status 3	52	146 (92H)
Analogue Alarm Status 4	54	147 (93H)
Sensor Break Alarm Status 1	56	148 (94H)
Sensor Break Alarm Status 2	58	149 (95H)
Sensor Break Alarm Status 3	60	150 (96H)
Sensor Break Alarm Status 4	62	151 (97H)
CT Alarm Status 1	64	152 (98H)
CT Alarm Status 2	66	153 (99H)
CT Alarm Status 3	68	154 (9AH)
CT Alarm Status 4	70	155 (9BH)
New Alarm Output	72	156 (9CH)
Any Alarm Output	74	157 (9DH)
New CT Alarm Output	76	158 (9EH)
Program Status	78	184 (B8H)
TOTAL LENGTH	80	

The default **output** assembly table.

Output Parameter	Offset	Value
Target SP - Loop 1	0	3
Auto/Manual - Loop 1	2	7
Manual Output - Loop 1	4	4
Target SP - Loop 2	6	17 (11H)
Auto/Manual - Loop 2	8	21 (15H)
Manual Output - Loop 2	10	18 (12H)
Target SP - Loop 3	12	31 (1FH)
Auto/Manual - Loop 3	14	35 (23H)
Manual Output - Loop 3	16	32 (20H)
Target SP - Loop 4	18	45 (2DH)
Auto/Manual - Loop 4	20	49 (31H)
Manual Output - Loop 4	22	46 (2EH)
Target SP - Loop 5	24	59 (3BH)
Auto/Manual - Loop 5	26	63 (3FH)
Manual Output - Loop 5	28	60 (3CH)
Target SP - Loop 6	30	73 (49H)
Auto/Manual - Loop 6	32	77 (4DH)
Manual Output - Loop 6	34	74 (4AH)
Target SP - Loop 7	36	87 (57H)
Auto/Manual - Loop 7	38	91 (5BH)
Manual Output - Loop 7	40	88 (58H)
Target SP - Loop 8	42	101 (65H)
Auto/Manual - Loop 8	44	105 (69H)
Manual Output - Loop 8	46	102 (66H)
TOTAL LENGTH	48	

25.2 Application Variables Object

This is the list of parameters available to be included in the input and output tables.

Parameter	Attribute ID
Process Variable - Loop 1	0
Working Setpoint - Loop 1	1
Working Output - Loop 1	2
Target Setpoint - Loop 1	3
Manual Output - Loop 1	4
Setpoint 1 - Loop 1	5
Setpoint 2 - Loop 1	6
Auto/Manual Mode - Loop 1	7
Proportional Band - Loop 1 working Set	8
Integral Time - Loop 1 working Set	9
Derivative Time - Loop 1 working Set	10
Cutback Low - Loop 1 working Set	11
Cutback High - Loop 1 working Set	12
Relative Cooling Gain - Loop 1 working Set	13
Process Variable - Loop 2	14
Working Setpoint - Loop 2	15
Working Output - Loop 2	16
Target Setpoint - Loop 2	17
Manual Output - Loop 2	18
Setpoint 1 - Loop 2	19
Setpoint 2 - Loop 2	20
Auto/Manual Mode - Loop 2	21
Proportional Band - Loop 2 working Set	22
Integral Time - Loop 2 working Set	23
Derivative Time - Loop 2 working Set	24
Cutback Low - Loop 2 working Set	25
Cutback High - Loop 2 working Set	26
Relative Cooling Gain - Loop 2 working Set	27

Parameter	Attribute ID
Process Variable - Loop 3	28
Working Setpoint - Loop 3	29
Working Output - Loop 3	30
Target Setpoint - Loop 3	31
Manual Output - Loop 3	32
Setpoint 1 - Loop 3	33
Setpoint 2 - Loop 3	34
Auto/Manual Mode - Loop 3	35
Proportional Band - Loop 3 working Set	36
Integral Time - Loop 3 working Set	37
Derivative Time - Loop 3 working Set	38
Cutback Low - Loop 3 working Set	39
Cutback High - Loop 3 working Set	40
Relative Cooling Gain - Loop 3 working Set	41
Process Variable - Loop 4	42
Working Setpoint - Loop 4	43
Working Output - Loop 4	44
Target Setpoint - Loop 4	45
Manual Output - Loop 4	46
Setpoint 1 - Loop 4	47
Setpoint 2 - Loop 4	48
Auto/Manual Mode - Loop 4	49
Proportional Band - Loop 4 working Set	50
Integral Time - Loop 4 working Set	51
Derivative Time - Loop 4 working Set	52
Cutback Low - Loop 4 working Set	53
Cutback High - Loop 4 working Set	54
Relative Cooling Gain - Loop 4 working Set	55
Process Variable - Loop 5	56
Working Setpoint - Loop 5	57
Working Output - Loop 5	58
Target Setpoint - Loop 5	59
Manual Output - Loop 5	60
Setpoint 1 - Loop 5	61
Setpoint 2 - Loop 5	62
Auto/Manual Mode - Loop 5	63
Proportional Band - Loop 5 working Set	64
Integral Time - Loop 5 working Set	65
Derivative Time - Loop 5 working Set	66
Cutback Low - Loop 5 working Set	67
Cutback High - Loop 5 working Set	68
Relative Cooling Gain - Loop 5 working Set	69
Process Variable - Loop 6	70
Working Setpoint - Loop 6	71
Working Output - Loop 6	72
Target Setpoint - Loop 6	73
Manual Output - Loop 6	74
Setpoint 1 - Loop 6	75
Setpoint 2 - Loop 6	76
Auto/Manual Mode - Loop 6	77
Proportional Band - Loop 6 working Set	78
Integral Time - Loop 6 working Set	79
Derivative Time - Loop 6 working Set	80
Cutback Low - Loop 6 working Set	81
Cutback High - Loop 6 working Set	82
Relative Cooling Gain - Loop 6 working Set	83
Process Variable - Loop 7	84
Working Setpoint - Loop 7	85
Working Output - Loop 7	86
Target Setpoint - Loop 7	87

Parameter	Attribute ID
Manual Output - Loop 7	88
Setpoint 1 - Loop 7	89
Setpoint 2 - Loop 7	90
Auto/Manual Mode - Loop 7	91
Proportional Band - Loop 7 working Set	92
Integral Time - Loop 7 working Set	93
Derivative Time - Loop 7 working Set	94
Cutback Low - Loop 7 working Set	95
Cutback High - Loop 7 working Set	96
Relative Cooling Gain - Loop 7 working Set	97
Process Variable - Loop 8	98
Working Setpoint - Loop 8	99
Working Output - Loop 8	100
Target Setpoint - Loop 8	101
Manual Output - Loop 8	102
Setpoint 1 - Loop 8	103
Setpoint 2 - Loop 8	104
Auto/Manual Mode - Loop 8	105
Proportional Band - Loop 8 working Set	106
Integral Time - Loop 8 working Set	107
Derivative Time - Loop 8 working Set	108
Cutback Low - Loop 8 working Set	109
Cutback High - Loop 8 working Set	110
Relative Cooling Gain - Loop 8 working Set	111
Module PV - Channel 1	112
Module PV - Channel 2	113
Module PV - Channel 3	114
Module PV - Channel 4	115
Module PV - Channel 5	116
Module PV - Channel 6	117
Module PV - Channel 7	118
Module PV - Channel 8	119
Module PV - Channel 9	120
Module PV - Channel 10	121
Module PV - Channel 11	122
Module PV - Channel 12	123
Module PV - Channel 13	124
Module PV - Channel 14	125
Module PV - Channel 15	126
Module PV - Channel 16	127
Module PV - Channel 17	128
Module PV - Channel 18	129
Module PV - Channel 19	130
Module PV - Channel 20	131
Module PV - Channel 21	132
Module PV - Channel 22	133
Module PV - Channel 23	134
Module PV - Channel 24	135
Module PV - Channel 25	136
Module PV - Channel 26	137
Module PV - Channel 27	138
Module PV - Channel 28	139
Module PV - Channel 29	140
Module PV - Channel 30	141
Module PV - Channel 31	142
Module PV - Channel 32	143
Analogue Alarm Status 1	144
Analogue Alarm Status 2	145
Analogue Alarm Status 3	146

Parameter	Attribute ID
Analogue Alarm Status 4	147
Sensor Break Alarm Status 1	148
Sensor Break Alarm Status 2	149
Sensor Break Alarm Status 3	150
Sensor Break Alarm Status 4	151
CT Alarm Status 1	152
CT Alarm Status 2	153
CT Alarm Status 3	154
CT Alarm Status 4	155
New Alarm Output	156
Any Alarm Output	157
New CT Alarm Output	158
Reset New Alarm	159
Reset New CT Alarm	160
CT Load Current 1	161
CT Load Current 2	162
CT Load Current 3	163
CT Load Current 4	164
CT Load Current 5	165
CT Load Current 6	166
CT Load Current 7	167
CT Load Current 8	168
CT Load Status 1	169
CT Load Status 2	170
CT Load Status 3	171
CT Load Status 4	172
CT Load Status 5	173
CT Load Status 6	174
CT Load Status 7	175
CT Load Status 8	176
PSU Relay 1 Output	177
PSU Relay 2 Output	178
PSU Digital Input 1	179
PSU Digital Input 2	180
Program Run	181
Program Hold	182
Program Reset	183
Program Status	184
Current Program	185
Program Time Left	186
Segment Time Left	187
User Value 1	188
User Value 2	189
User Value 3	190
User Value 4	191
User Value 5	192
User Value 6	193
User Value 7	194
User Value 8	195
User Value 9	196
User Value 10	197
User Value 11	198
User Value 12	199

25.2.1 Table Modification

Make a list of parameters required in the input and output tables to suit the application. If the parameter is listed in the predefined list then use the attribute number of that parameter.

To set up the controller so that the required parameters are available on the network requires setting up the INPUT and OUTPUT data assembly tables with the IDs from the Application Variable Object.

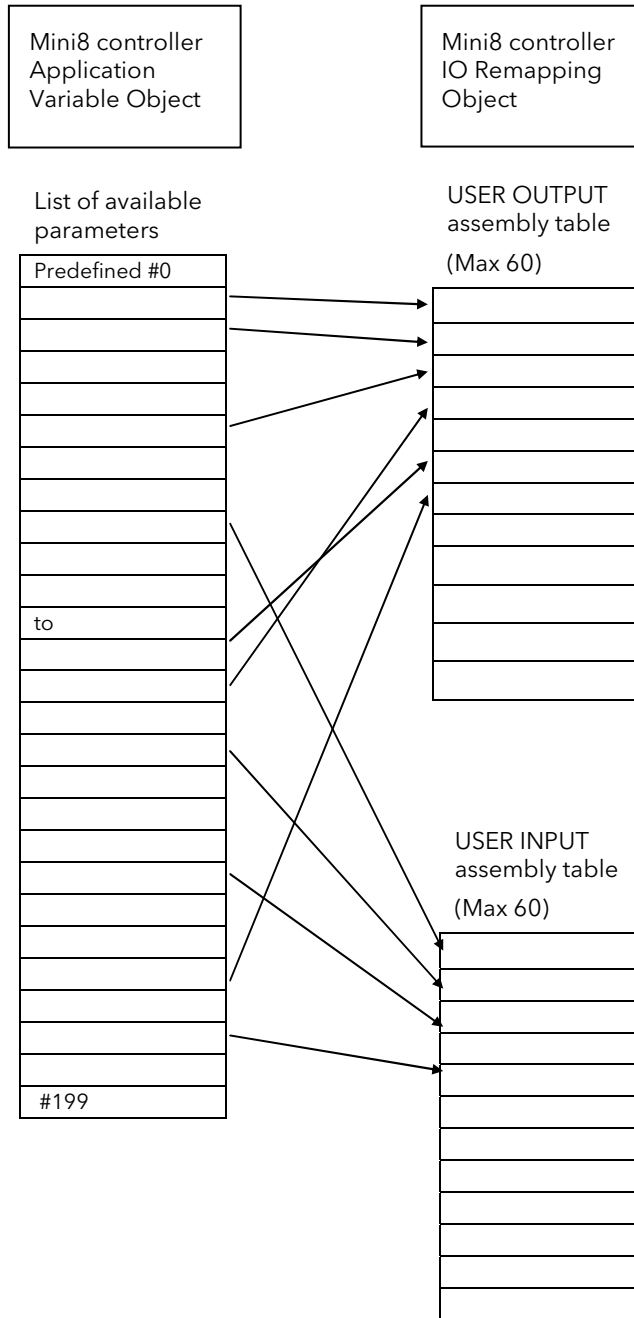

26. Appendix C CANOPEN PARAMETER TABLES

26.1 Manufacturer Object - Pick List

Object Index 2000h	Sub Index	Parameter	Data Type	SCADA Address
<i>Receive PDO1 Note: Sub indices 02h - 04h are letter boxed via sub index 01h.</i>				
	01h	Loop Number (Comms.InstNum1)	Integer16	15816
	02h	Loop.n.Main.TargetSP	Integer16	15817
	03h	Loop.n.Main.AutoMan	Integer16	15818
	04h	Loop.n.OP.ManualOutVal	Integer16	15819
<i>Receive PDO2 Note: Sub indices 06h - 08h are letter boxed via sub index 05h.</i>				
	05h	Loop Number (Comms.InstNum2)	Integer16	15820
	06h	Loop.n.PID.ProportionalBand	Integer16	15821
	07h	Loop.n.PID.IntegralTime	Integer16	15822
	08h	Loop.n.PID.DerivativeTime	Integer16	15823
<i>Receive PDO3 Note: Sub indices 0Ah - 0Ch are letter boxed via sub index 09h.</i>				
	09h	Loop Number (Comms.InstNum3)	Integer16	15824
	0Ah	Loop.n.SP.SP1	Integer16	15825
	0Bh	Loop.n.SP.SP2	Integer16	15826
	0Ch	Loop.n.SP.SPSelect	Integer16	15827
<i>Receive PDO Note: Sub indices 0Eh - 10h are letter boxed via sub index 0Dh.</i>				
	0Dh	Programmer Number (Comms.InstNum4)	Integer16	15828
	0Eh	Programmer.n.SetUp.ProgRun	Integer16	15829
	0Fh	Programmer.n.SetUp.ProgHold	Integer16	15830
	10h	Programmer.n.SetUp.ProgReset	Integer16	15831
<i>Transmit PDO1</i>				
	11h	AlmSummary.General.AnAlarmStatus1	Integer16	15832
	12h	AlmSummary.General.AnAlarmStatus2	Integer16	15833
	13h	AlmSummary.General.AnAlarmStatus3	Integer16	15834
	14h	AlmSummary.General.AnAlarmStatus4	Integer16	15835
<i>Transmit PDO2</i>				
	15h	AlmSummary.General.SbrkAlarmStatus1	Integer16	15836
	16h	AlmSummary.General.SbrkAlarmStatus2	Integer16	15837
	17h	AlmSummary.General.SbrkAlarmStatus3	Integer16	15838
	18h	AlmSummary.General.SbrkAlarmStatus4	Integer16	15839
<i>Transmit PDO3 Note: Sub indices 1Ah - 1Ch are letter boxed via sub index 19h.</i>				
	19h	Loop Number (Comms.InstNum5)	Integer16	15840
	1Ah	Loop.n.Main.PV	Integer16	15841
	1Bh	Loop.n.Main.WorkingSP	Integer16	15842
	1Ch	Loop.n.Main.ActiveOut	Integer16	15843
<i>Transmit PDO4 Note: Sub indices 1Eh - 20h are letter boxed via sub index 1Dh.</i>				
	1Dh	Programmer Number (Comms.InstNum6)	Integer16	15844
	1Eh	Programmer.n.Run.CurProg	Integer16	15845
	1Fh	Programmer.n.Run.ProgStatus	Integer16	15846
	20h	Programmer.n.Run.ProgTimeLeft	Integer16	15847
	21h	Loop.1.Main.PV	Integer16	15848
	22h	Loop.2.Main.PV	Integer16	15849
	23h	Loop.3.Main.PV	Integer16	15850
	24h	Loop.4.Main.PV	Integer16	15851
	25h	Loop.5.Main.PV	Integer16	15852
	26h	Loop.6.Main.PV	Integer16	15853
	27h	Loop.7.Main.PV	Integer16	15854
	28h	Loop.8.Main.PV	Integer16	15855
	29h	Loop.9.Main.PV	Integer16	15856
	2Ah	Loop.10.Main.PV	Integer16	15857
	2Bh	Loop.11.Main.PV	Integer16	15858
	2Ch	Loop.12.Main.PV	Integer16	15859
	2Dh	Loop.13.Main.PV	Integer16	15860

Object Index 2000h	Sub Index	Parameter	Data Type	SCADA Address
	2Eh	Loop.14.Main.PV	Integer16	15861
	2Fh	Loop.15.Main.PV	Integer16	15862
	30h	Loop.16.Main.PV	Integer16	15863
	31h	Loop.1.Main.WorkingSP	Integer16	15864
	32h	Loop.2.Main.WorkingSP	Integer16	15865
	33h	Loop.3.Main.WorkingSP	Integer16	15866
	34h	Loop.4.Main.WorkingSP	Integer16	15867
	35h	Loop.5.Main.WorkingSP	Integer16	15868
	36h	Loop.6.Main.WorkingSP	Integer16	15869
	37h	Loop.7.Main.WorkingSP	Integer16	15870
	38h	Loop.8.Main.WorkingSP	Integer16	15871
	39h	Loop.9.Main.WorkingSP	Integer16	15872
	3Ah	Loop.10.Main.WorkingSP	Integer16	15873
	3Bh	Loop.11.Main.WorkingSP	Integer16	15874
	3Ch	Loop.12.Main.WorkingSP	Integer16	15875
	3Dh	Loop.13.Main.WorkingSP	Integer16	15876
	3Eh	Loop.14.Main.WorkingSP	Integer16	15877
	3Fh	Loop.15.Main.WorkingSP	Integer16	15878
	40h	Loop.16.Main.WorkingSP	Integer16	15879
	41h	Loop.1.Main.ActiveOut	Integer16	15880
	42h	Loop.2.Main.ActiveOut	Integer16	15881
	43h	Loop.3.Main.ActiveOut	Integer16	15882
	44h	Loop.4.Main.ActiveOut	Integer16	15883
	45h	Loop.5.Main.ActiveOut	Integer16	15884
	46h	Loop.6.Main.ActiveOut	Integer16	15885
	47h	Loop.7.Main.ActiveOut	Integer16	15886
	48h	Loop.8.Main.ActiveOut	Integer16	15887
	49h	Loop.9.Main.ActiveOut	Integer16	15888
	4Ah	Loop.10.Main.ActiveOut	Integer16	15889
	4Bh	Loop.11.Main.ActiveOut	Integer16	15890
	4Ch	Loop.12.Main.ActiveOut	Integer16	15891
	4Dh	Loop.13.Main.ActiveOut	Integer16	15892
	4Eh	Loop.14.Main.ActiveOut	Integer16	15893
	4Fh	Loop.15.Main.ActiveOut	Integer16	15894
	50h	Loop.16.Main.ActiveOut	Integer16	15895
	51h	Loop.1.Main.TargetSP	Integer16	15896
	52h	Loop.2.Main.TargetSP	Integer16	15897
	53h	Loop.3.Main.TargetSP	Integer16	15898
	54h	Loop.4.Main.TargetSP	Integer16	15899
	55h	Loop.5.Main.TargetSP	Integer16	15900
	56h	Loop.6.Main.TargetSP	Integer16	15901
	57h	Loop.7.Main.TargetSP	Integer16	15902
	58h	Loop.8.Main.TargetSP	Integer16	15903
	59h	Loop.9.Main.TargetSP	Integer16	15904
	5Ah	Loop.10.Main.TargetSP	Integer16	15905
	5Bh	Loop.11.Main.TargetSP	Integer16	15906
	5Ch	Loop.12.Main.TargetSP	Integer16	15907
	5Dh	Loop.13.Main.TargetSP	Integer16	15908
	5Eh	Loop.14.Main.TargetSP	Integer16	15909
	5Fh	Loop.15.Main.TargetSP	Integer16	15910
	60h	Loop.16.Main.TargetSP	Integer16	15911
	61h	Loop.1.OP.ManualOutVal	Integer16	15912
	62h	Loop.2.OP.ManualOutVal	Integer16	15913
	63h	Loop.3.OP.ManualOutVal	Integer16	15914
	64h	Loop.4.OP.ManualOutVal	Integer16	15915
	65h	Loop.5.OP.ManualOutVal	Integer16	15916
	66h	Loop.6.OP.ManualOutVal	Integer16	15917

Object Index 2000h	Sub Index	Parameter	Data Type	SCADA Address
	67h	Loop.7.OP.ManualOutVal	Integer16	15918
	68h	Loop.8.OP.ManualOutVal	Integer16	15919
	69h	Loop.9.OP.ManualOutVal	Integer16	15920
	6Ah	Loop.10.OP.ManualOutVal	Integer16	15921
	6Bh	Loop.11.OP.ManualOutVal	Integer16	15922
	6Ch	Loop.12.OP.ManualOutVal	Integer16	15923
	6Dh	Loop.13.OP.ManualOutVal	Integer16	15924
	6Eh	Loop.14.OP.ManualOutVal	Integer16	15925
	6Fh	Loop.15.OP.ManualOutVal	Integer16	15926
	70h	Loop.16.OP.ManualOutVal	Integer16	15927
	71h	Loop.1.Main.AutoMan	Integer16	15928
	72h	Loop.2.Main.AutoMan	Integer16	15929
	73h	Loop.3.Main.AutoMan	Integer16	15930
	74h	Loop.4.Main.AutoMan	Integer16	15931
	75h	Loop.5.Main.AutoMan	Integer16	15932
	76h	Loop.6.Main.AutoMan	Integer16	15933
	77h	Loop.7.Main.AutoMan	Integer16	15934
	78h	Loop.8.Main.AutoMan	Integer16	15935
	79h	Loop.9.Main.AutoMan	Integer16	15936
	7Ah	Loop.10.Main.AutoMan	Integer16	15937
	7Bh	Loop.11.Main.AutoMan	Integer16	15938
	7Ch	Loop.12.Main.AutoMan	Integer16	15939
	7Dh	Loop.13.Main.AutoMan	Integer16	15940
	7Eh	Loop.14.Main.AutoMan	Integer16	15941
	7Fh	Loop.15.Main.AutoMan	Integer16	15942
	80h	Loop.16.Main.AutoMan	Integer16	15943
	81h	IO.Mod.1.PV	Integer16	15944
	82h	IO.Mod.2.PV	Integer16	15945
	83h	IO.Mod.3.PV	Integer16	15946
	84h	IO.Mod.4.PV	Integer16	15947
	85h	IO.Mod.5.PV	Integer16	15948
	86h	IO.Mod.6.PV	Integer16	15949
	87h	IO.Mod.7.PV	Integer16	15950
	88h	IO.Mod.8.PV	Integer16	15951
	89h	IO.Mod.9.PV	Integer16	15952
	8Ah	IO.Mod.10.PV	Integer16	15953
	8Bh	IO.Mod.11.PV	Integer16	15954
	8Ch	IO.Mod.12.PV	Integer16	15955
	8Dh	IO.Mod.13.PV	Integer16	15956
	8Eh	IO.Mod.14.PV	Integer16	15957
	8Fh	IO.Mod.15.PV	Integer16	15958
	90h	IO.Mod.16.PV	Integer16	15959
	91h	IO.Mod.17.PV	Integer16	15960
	92h	IO.Mod.18.PV	Integer16	15961
	93h	IO.Mod.19.PV	Integer16	15962
	94h	IO.Mod.20.PV	Integer16	15963
	95h	IO.Mod.21.PV	Integer16	15964
	96h	IO.Mod.22.PV	Integer16	15965
	97h	IO.Mod.23.PV	Integer16	15966
	98h	IO.Mod.24.PV	Integer16	15967
	99h	IO.Mod.25.PV	Integer16	15968
	9Ah	IO.Mod.26.PV	Integer16	15969
	9Bh	IO.Mod.27.PV	Integer16	15970
	9Ch	IO.Mod.28.PV	Integer16	15971
	9Dh	IO.Mod.29.PV	Integer16	15972
	9Eh	IO.Mod.30.PV	Integer16	15973
	9Fh	IO.Mod.31.PV	Integer16	15974
	A0h	IO.Mod.32.PV	Integer16	15975

Object Index 2000h	Sub Index	Parameter	Data Type	SCADA Address
	A1h	IO.FixedIO.A.PV	Integer16	15976
	A2h	IO.FixedIO.B.PV	Integer16	15977
	A3h	IO.FixedIO.D1.PV	Integer16	15978
	A4h	IO.FixedIO.D2.PV	Integer16	15979
	A5h	IO.CurrentMonitor.Status.Load1Current	Integer16	15980
	A6h	IO.CurrentMonitor.Status.Load2Current	Integer16	15981
	A7h	IO.CurrentMonitor.Status.Load3Current	Integer16	15982
	A8h	IO.CurrentMonitor.Status.Load4Current	Integer16	15983
	A9h	IO.CurrentMonitor.Status.Load5Current	Integer16	15984
	AAh	IO.CurrentMonitor.Status.Load6Current	Integer16	15985
	ABh	IO.CurrentMonitor.Status.Load7Current	Integer16	15986
	ACh	IO.CurrentMonitor.Status.Load8Current	Integer16	15987
	ADh	IO.CurrentMonitor.Status.Load1Status	Integer16	15988
	A Eh	IO.CurrentMonitor.Status.Load2Status	Integer16	15989
	AFh	IO.CurrentMonitor.Status.Load3Status	Integer16	15990
	B0h	IO.CurrentMonitor.Status.Load4Status	Integer16	15991
	B1h	IO.CurrentMonitor.Status.Load5Status	Integer16	15992
	B2h	IO.CurrentMonitor.Status.Load6Status	Integer16	15993
	B3h	IO.CurrentMonitor.Status.Load7Status	Integer16	15994
	B4h	IO.CurrentMonitor.Status.Load8Status	Integer16	15995
	B5h	AlmSummary.General.AnyAlarm	Integer16	15996
	B6h	AlmSummary.General.NewAlarm	Integer16	15997
	B7h	AlmSummary.General.NewCTAlarm	Integer16	15998
	B8h	AlmSummary.General.RstNewAlarm	Integer16	15999
	B9h	AlmSummary.General.RstNewCTAlarm	Integer16	16000
	BAh	AlmSummary.General.CTAlarmStatus1	Integer16	16001
	BBh	AlmSummary.General.CTAlarmStatus2	Integer16	16002
	BCh	AlmSummary.General.CTAlarmStatus3	Integer16	16003
	BDh	AlmSummary.General.CTAlarmStatus4	Integer16	16004
	BEh	AlmSummary.General.DigAlarmStatus1	Integer16	16005
	BFh	AlmSummary.General.DigAlarmStatus2	Integer16	16006
	C0h	AlmSummary.General.DigAlarmStatus3	Integer16	16007
	C1h	AlmSummary.General.DigAlarmStatus4	Integer16	16008
	C2h	AlmSummary.General.GlobalAck	Integer16	16009
	C3h	UserVal.1.Val	Integer16	16010
	C4h	UserVal.2.Val	Integer16	16011
	C5h	UserVal.3.Val	Integer16	16012
	C6h	UserVal.4.Val	Integer16	16013
	C7h	UserVal.5.Val	Integer16	16014
	C8h	UserVal.6.Val	Integer16	16015

27. Appendix D Version 1.xx Programmer

27.1 Version 1.xx Parameter Tables

27.1.1 Configuring the Programmer (V1.xx)

Programmer.1.Setup contains the general configuration settings for the Programmer Block. Programs are created and stored in the **Program** Folder. Once a Program exists it can be run using the parameters in the **Programmer.1.Run** folder.

Folder - Programmer.1		Sub-folder: Setup			
Name	Parameter Description	Value		Default	Access Level
Units	Units of the Output			None	Conf
Resolution	Programmer Output resolution	X to X.XXXX			Conf
PVIn	The programmer uses the PV input for a number of functions In holdback, the PV is monitored against the setpoint, and if a deviation occurs the program is paused. The programmer can be configured to start its profile from the current PV value (servo to PV). The programmer monitors the PV value for Sensor Break. The programmer holds in sensor break.	The PV Input is normally wired from the loop TrackPV parameter. Note: This input is automatically wired when the programmer and loop are enabled and there are no existing wires to track interface parameters. Track interface parameters are Programmer.Setup, PVInput, SPInInput, Loop.SP, AltSP, Loop.SP, AltSPSelect.			Conf
SPIn	The programmer needs to know the working setpoint of the loop it is profiling. The SP input is used in the servo to setpoint start type.	SP Input is normally wired from the loop Track SP parameter as the PV input.			Conf
Servo	The transfer of program setpoint to PV Input (normally the Loop PV) or the SP Input (normally the Loop setpoint).	PV SP	See also section 18.7.1		Conf
PowerFailAct	Power fail recovery strategy	Ramp	See section 18.8.		Conf
		Reset			
		Cont			
SyncIn	The synchronise input is a way of synchronising programs. At the end of a segment the programmer will inspect the sync. input, if it is True (1) then the programmer will advance to the next segment. It is typically wired from the end of segment output of another programmer. Only appears if 'SyncMode' = 'Yes'	0 1	This will normally be wired to the 'End of Seg' parameter.		Oper
Max Events	To set the maximum number of output events required for the program. This is for convenience to avoid having to scroll through unwanted events when setting up each segment	1 to 8			Conf
SyncMode	Allows multiple controllers to be synchronised at the end of each segment	No	Sync output disabled		Conf
		Yes	Sync output enabled		
Prog Reset	Flag showing reset state	No/Yes	Can be wired to logic inputs to provide remote program control		Oper
Prog Run	Flag showing run state	No/Yes			Oper
Prog Hold	Flag showing hold state	No/Yes			Oper
AdvSeg	Set output to target setpoint and advance to next segment	No/Yes			Oper
SkipSeg	Skip to the next setpoint and start the segment at the current output value.	No/Yes			Oper
EventOut1 to 8	Flags showing event states	No/Yes			R/O
End of Seg	Flag showing end of segment state	No/Yes			R/O

27.1.2 To Select, Run, Hold or Reset a Program (V1.xx).

The 'Run' folder allows an existing program to be selected and run. The folder also shows the current program status:

Folder - Programmer.1		Sub-folder: Run		
Name	Parameter Description	Value	Default	Access Level
CurProg	Current Program Number	0 to 50. Change only when Programmer is in Reset.	0	Oper R/O
CurrSeg	Current Running Segment	1 to 255	1	R/O
ProgStatus	Program Status	Reset - Run - Hold - Holdback - End -		Oper
PSP	Programmer Setpoint		0	R/O
CyclesLeft	Number of Cycles Remaining	0 to 1000	0	R/O
CurSegType	Current Segment type	End Rate Time Dwell Step Call	End	R/O
SegTimeLeft	Segment Time Remaining	Hr Min Sec Millisec	0	R/O
ResetEventOP	Reset Event Outputs	0 to 255, each bit resets its corresponding output	0	Oper
SegTarget	Current Target Setpoint Value			R/O
SegRate	Segment Ramp Rate	0.1 to 9999.9	0	R/O
ProgTimeLeft	Program Time Remaining	Hrs Min Sec Millisec	0	R/O
FastRun	Fast Run	No (0) Normal Yes (1) Program executes at 10 times real time	No	Conf
EndOutput	End Output	Off (0) Program not in End On (1) Program at End	Off	R/O
EventsOut	Event Outputs	0 to 255, each bit represents an output.	0	R/O

27.1.3 Creating a Program (V1.xx)

A folder exists for each Program containing a few key parameters listed below. This folder would normally be viewed via the iTools Program Editor under the Program Parameters tab. The Program Editor is used to create the segments of Program itself using the Segment Editor tab.

Folder - Program		Sub-folder: 1 to 50		
Name	Parameter Description	Value	Default	Access Level
Name	Program Name	Up to 8 characters	Null	Oper
Holdback Value	Deviation between SP and PV at which holdback is applied. This value applies to the whole program.	Minimum setting 0	0	Oper
Ramp Units	Time units applied to the segments	Sec Min Hour	Seconds Minutes Hours	sec Oper
Cycles	Number of times the whole program repeats	Cont (0) 1 to 999	Repeats continuously Program executes once to 999 times	1 Oper

27.1.4 To Select, Run, Hold or Reset a Program (Version 1.xx)

The 'Run' folder allows an existing program to be selected and run. The folder also shows the current program status:

Folder - Programmer.1		Sub-folder: Run		
Name	Parameter Description	Value	Default	Access Level
CurProg	Current Program Number	0 to 50. Change only when Programmer is in Reset.	0	Oper R/O
CurrSeg	Current Running Segment	1 to 255	1	R/O
ProgStatus	Program Status	Reset - Run - Hold - Holdback - End -		Oper
PSP	Programmer Setpoint		0	R/O
CyclesLeft	Number of Cycles Remaining	0 to 1000	0	R/O
CurSegType	Current Segment type	End Rate Time Dwell Step Call	End	R/O
SegTimeLeft	Segment Time Remaining	Hr Min Sec Millisec	0	R/O
ResetEventOP	Reset Event Outputs	0 to 255, each bit resets its corresponding output	0	Oper
SegTarget	Current Target Setpoint Value			R/O
SegRate	Segment Ramp Rate	0.1 to 9999.9	0	R/O
ProgTimeLeft	Program Time Remaining	Hrs Min Sec Millisec	0	R/O
FastRun	Fast Run	No (0) Normal Yes (1) Program executes at 10 times real time	No	Conf
EndOutput	End Output	Off (0) Program not in End On (1) Program at End	Off	R/O
EventsOut	Event Outputs	0 to 255, each bit represents an output.	0	R/O

27.2 SCADA addresses for Programmer Version 1.xx

Version 1.xx Programmer Parameters	DEC	HEX
Program.Cycles	8196	2004
Program.DwellUnits	8195	2003
Program.HoldbackVal	8193	2001
Program.RampUnits	8194	2002
Programmer.CommsProgNum	8192	2000
Programmer.Run.CurProg	8201	2009
Programmer.Run.CurSeg	8202	200A
Programmer.Run.CurSegType	8206	200E
Programmer.Run.CyclesLeft	8205	200D
Programmer.Run.EventOuts	8212	2014
Programmer.Run.FastRun	8216	2018
Programmer.Run.ProgStatus	8203	200B
Programmer.Run.ProgTimeLeft	8209	2011
Programmer.Run.PSP	8204	200C
Programmer.Run.ResetEventOuts	8200	2008
Programmer.Run.SegRate	8208	2010
Programmer.Run.SegTarget	8207	200F

Version 1.xx Programmer Parameters	DEC	HEX
Programmer.Run.SegTimeLeft	8213	2015
Programmer.Setup.AdvSeg	8217	2019
Programmer.Setup.EndOfSeg	8214	2016
Programmer.Setup.PowerFailAct	8197	2005
Programmer.Setup.PVIn	8210	2012
Programmer.Setup.Servo	8198	2006
Programmer.Setup.SkipSeg	8218	201A
Programmer.Setup.SPIn	8211	2013
Programmer.Setup.SyncIn	8215	2017
Programmer.Setup.SyncMode	8199	2007
Recipe.LastDataset	4913	1331
Recipe.LoadingStatus	4914	1332
Recipe.RecipeSelect	4912	1330
Segment.1.CallCycles	8259	2043
Segment.1.CallProg	8258	2042
Segment.1.Duration	8260	2044
Segment.1.EndType	8263	2047

Version 1.xx Programmer Parameters	DEC	HEX
Segment.1.EventOuts	8264	2048
Segment.1.Holdback	8257	2041
Segment.1.RampRate	8261	2045
Segment.1.SegType	8256	2040
Segment.1.TargetSP	8262	2046
Segment.2.CallCycles	8275	2053
Segment.2.CallProg	8274	2052
Segment.2.Duration	8276	2054
Segment.2.EndType	8279	2057
Segment.2.EventOuts	8280	2058
Segment.2.Holdback	8273	2051
Segment.2.RampRate	8277	2055
Segment.2.SegType	8272	2050
Segment.2.TargetSP	8278	2056
Segment.3.CallCycles	8291	2063
Segment.3.CallProg	8290	2062
Segment.3.Duration	8292	2064
Segment.3.EndType	8295	2067
Segment.3.EventOuts	8296	2068
Segment.3.Holdback	8289	2061
Segment.3.RampRate	8293	2065
Segment.3.SegType	8288	2060
Segment.3.TargetSP	8294	2066
Segment.4.CallCycles	8307	2073
Segment.4.CallProg	8306	2072
Segment.4.Duration	8308	2074
Segment.4.EndType	8311	2077
Segment.4.EventOuts	8312	2078
Segment.4.Holdback	8305	2071
Segment.4.RampRate	8309	2075
Segment.4.SegType	8304	2070
Segment.4.TargetSP	8310	2076
Segment.5.CallCycles	8323	2083
Segment.5.CallProg	8322	2082
Segment.5.Duration	8324	2084
Segment.5.EndType	8327	2087
Segment.5.EventOuts	8328	2088
Segment.5.Holdback	8321	2081
Segment.5.RampRate	8325	2085
Segment.5.SegType	8320	2080
Segment.5.TargetSP	8326	2086
Segment.6.CallCycles	8339	2093
Segment.6.CallProg	8338	2092
Segment.6.Duration	8340	2094
Segment.6.EndType	8343	2097
Segment.6.EventOuts	8344	2098
Segment.6.Holdback	8337	2091
Segment.6.RampRate	8341	2095
Segment.6.SegType	8336	2090
Segment.6.TargetSP	8342	2096
Segment.7.CallCycles	8355	20A3
Segment.7.CallProg	8354	20A2
Segment.7.Duration	8356	20A4

Version 1.xx Programmer Parameters	DEC	HEX
Segment.7.EndType	8359	20A7
Segment.7.EventOuts	8360	20A8
Segment.7.Holdback	8353	20A1
Segment.7.RampRate	8357	20A5
Segment.7.SegType	8352	20A0
Segment.7.TargetSP	8358	20A6
Segment.8.CallCycles	8371	20B3
Segment.8.CallProg	8370	20B2
Segment.8.Duration	8372	20B4
Segment.8.EndType	8375	20B7
Segment.8.EventOuts	8376	20B8
Segment.8.Holdback	8369	20B1
Segment.8.RampRate	8373	20B5
Segment.8.SegType	8368	20B0
Segment.8.TargetSP	8374	20B6
Segment.9.CallCycles	8387	20C3
Segment.9.CallProg	8386	20C2
Segment.9.Duration	8388	20C4
Segment.9.EndType	8391	20C7
Segment.9.EventOuts	8392	20C8
Segment.9.Holdback	8385	20C1
Segment.9.RampRate	8389	20C5
Segment.9.SegType	8384	20C0
Segment.9.TargetSP	8390	20C6
Segment.10.CallCycles	8403	20D3
Segment.10.CallProg	8402	20D2
Segment.10.Duration	8404	20D4
Segment.10.EndType	8407	20D7
Segment.10.EventOuts	8408	20D8
Segment.10.Holdback	8401	20D1
Segment.10.RampRate	8405	20D5
Segment.10.SegType	8400	20D0
Segment.10.TargetSP	8406	20D6
Segment.11.CallCycles	8419	20E3
Segment.11.CallProg	8418	20E2
Segment.11.Duration	8420	20E4
Segment.11.EndType	8423	20E7
Segment.11.EventOuts	8424	20E8
Segment.11.Holdback	8417	20E1
Segment.11.RampRate	8421	20E5
Segment.11.SegType	8416	20E0
Segment.11.TargetSP	8422	20E6
Segment.12.CallCycles	8435	20F3
Segment.12.CallProg	8434	20F2
Segment.12.Duration	8436	20F4
Segment.12.EndType	8439	20F7
Segment.12.EventOuts	8440	20F8
Segment.12.Holdback	8433	20F1
Segment.12.RampRate	8437	20F5
Segment.12.SegType	8432	20F0
Segment.12.TargetSP	8438	20F6
Segment.13.CallCycles	8451	2103
Segment.13.CallProg	8450	2102

Version 1.xx Programmer Parameters	DEC	HEX
Segment.13.Duration	8452	2104
Segment.13.EndType	8455	2107
Segment.13.EventOuts	8456	2108
Segment.13.Holdback	8449	2101
Segment.13.RampRate	8453	2105
Segment.13.SegType	8448	2100
Segment.13.TargetSP	8454	2106
Segment.14.CallCycles	8467	2113
Segment.14.CallProg	8466	2112
Segment.14.Duration	8468	2114
Segment.14.EndType	8471	2117
Segment.14.EventOuts	8472	2118
Segment.14.Holdback	8465	2111
Segment.14.RampRate	8469	2115
Segment.14.SegType	8464	2110
Segment.14.TargetSP	8470	2116
Segment.15.CallCycles	8483	2123
Segment.15.CallProg	8482	2122
Segment.15.Duration	8484	2124
Segment.15.EndType	8487	2127
Segment.15.EventOuts	8488	2128
Segment.15.Holdback	8481	2121
Segment.15.RampRate	8485	2125
Segment.15.SegType	8480	2120
Segment.15.TargetSP	8486	2126
Segment.16.CallCycles	8499	2133
Segment.16.CallProg	8498	2132
Segment.16.Duration	8500	2134
Segment.16.EndType	8503	2137
Segment.16.EventOuts	8504	2138
Segment.16.Holdback	8497	2131
Segment.16.RampRate	8501	2135
Segment.16.SegType	8496	2130
Segment.16.TargetSP	8502	2136
Segment.17.CallCycles	8515	2143
Segment.17.CallProg	8514	2142
Segment.17.Duration	8516	2144
Segment.17.EndType	8519	2147
Segment.17.EventOuts	8520	2148
Segment.17.Holdback	8513	2141
Segment.17.RampRate	8517	2145
Segment.17.SegType	8512	2140
Segment.17.TargetSP	8518	2146
Segment.18.CallCycles	8531	2153
Segment.18.CallProg	8530	2152
Segment.18.Duration	8532	2154
Segment.18.EndType	8535	2157
Segment.18.EventOuts	8536	2158
Segment.18.Holdback	8529	2151
Segment.18.RampRate	8533	2155
Segment.18.SegType	8528	2150
Segment.18.TargetSP	8534	2156
Segment.19.CallCycles	8547	2163

Version 1.xx Programmer Parameters	DEC	HEX
Segment.19.CallProg	8546	2162
Segment.19.Duration	8548	2164
Segment.19.EndType	8551	2167
Segment.19.EventOuts	8552	2168
Segment.19.Holdback	8545	2161
Segment.19.RampRate	8549	2165
Segment.19.SegType	8544	2160
Segment.19.TargetSP	8550	2166
Segment.20.CallCycles	8563	2173
Segment.20.CallProg	8562	2172
Segment.20.Duration	8564	2174
Segment.20.EndType	8567	2177
Segment.20.EventOuts	8568	2178
Segment.20.Holdback	8561	2171
Segment.20.RampRate	8565	2175
Segment.20.SegType	8560	2170
Segment.20.TargetSP	8566	2176
Segment.21.CallCycles	8579	2183
Segment.21.CallProg	8578	2182
Segment.21.Duration	8580	2184
Segment.21.EndType	8583	2187
Segment.21.EventOuts	8584	2188
Segment.21.Holdback	8577	2181
Segment.21.RampRate	8581	2185
Segment.21.SegType	8576	2180
Segment.21.TargetSP	8582	2186
Segment.22.CallCycles	8595	2193
Segment.22.CallProg	8594	2192
Segment.22.Duration	8596	2194
Segment.22.EndType	8599	2197
Segment.22.EventOuts	8600	2198
Segment.22.Holdback	8593	2191
Segment.22.RampRate	8597	2195
Segment.22.SegType	8592	2190
Segment.22.TargetSP	8598	2196
Segment.23.CallCycles	8611	21A3
Segment.23.CallProg	8610	21A2
Segment.23.Duration	8612	21A4
Segment.23.EndType	8615	21A7
Segment.23.EventOuts	8616	21A8
Segment.23.Holdback	8609	21A1
Segment.23.RampRate	8613	21A5
Segment.23.SegType	8608	21A0
Segment.23.TargetSP	8614	21A6
Segment.24.CallCycles	8627	21B3
Segment.24.CallProg	8626	21B2
Segment.24.Duration	8628	21B4
Segment.24.EndType	8631	21B7
Segment.24.EventOuts	8632	21B8
Segment.24.Holdback	8625	21B1
Segment.24.RampRate	8629	21B5
Segment.24.SegType	8624	21B0
Segment.24.TargetSP	8630	21B6

Version 1.xx Programmer Parameters	DEC	HEX
Segment.25.CallCycles	8643	21C3
Segment.25.CallProg	8642	21C2
Segment.25.Duration	8644	21C4
Segment.25.EndType	8647	21C7
Segment.25.EventOuts	8648	21C8
Segment.25.Holdback	8641	21C1
Segment.25.RampRate	8645	21C5
Segment.25.SegType	8640	21C0
Segment.25.TargetSP	8646	21C6
Segment.26.CallCycles	8659	21D3
Segment.26.CallProg	8658	21D2
Segment.26.Duration	8660	21D4
Segment.26.EndType	8663	21D7
Segment.26.EventOuts	8664	21D8
Segment.26.Holdback	8657	21D1
Segment.26.RampRate	8661	21D5
Segment.26.SegType	8656	21D0
Segment.26.TargetSP	8662	21D6
Segment.27.CallCycles	8675	21E3
Segment.27.CallProg	8674	21E2
Segment.27.Duration	8676	21E4
Segment.27.EndType	8679	21E7
Segment.27.EventOuts	8680	21E8
Segment.27.Holdback	8673	21E1
Segment.27.RampRate	8677	21E5
Segment.27.SegType	8672	21E0
Segment.27.TargetSP	8678	21E6
Segment.28.CallCycles	8691	21F3
Segment.28.CallProg	8690	21F2
Segment.28.Duration	8692	21F4
Segment.28.EndType	8695	21F7
Segment.28.EventOuts	8696	21F8
Segment.28.Holdback	8689	21F1
Segment.28.RampRate	8693	21F5
Segment.28.SegType	8688	21F0
Segment.28.TargetSP	8694	21F6
Segment.29.CallCycles	8707	2203
Segment.29.CallProg	8706	2202
Segment.29.Duration	8708	2204
Segment.29.EndType	8711	2207
Segment.29.EventOuts	8712	2208
Segment.29.Holdback	8705	2201
Segment.29.RampRate	8709	2205
Segment.29.SegType	8704	2200
Segment.29.TargetSP	8710	2206
Segment.30.CallCycles	8723	2213
Segment.30.CallProg	8722	2212
Segment.30.Duration	8724	2214
Segment.30.EndType	8727	2217
Segment.30.EventOuts	8728	2218
Segment.30.Holdback	8721	2211
Segment.30.RampRate	8725	2215
Segment.30.SegType	8720	2210

Version 1.xx Programmer Parameters	DEC	HEX
Segment.30.TargetSP	8726	2216
Segment.31.CallCycles	8739	2223
Segment.31.CallProg	8738	2222
Segment.31.Duration	8740	2224
Segment.31.EndType	8743	2227
Segment.31.EventOuts	8744	2228
Segment.31.Holdback	8737	2221
Segment.31.RampRate	8741	2225
Segment.31.SegType	8736	2220
Segment.31.TargetSP	8742	2226
Segment.32.CallCycles	8755	2233
Segment.32.CallProg	8754	2232
Segment.32.Duration	8756	2234
Segment.32.EndType	8759	2237
Segment.32.EventOuts	8760	2238
Segment.32.Holdback	8753	2231
Segment.32.RampRate	8757	2235
Segment.32.SegType	8752	2230
Segment.32.TargetSP	8758	2236
Segment.33.CallCycles	8771	2243
Segment.33.CallProg	8770	2242
Segment.33.Duration	8772	2244
Segment.33.EndType	8775	2247
Segment.33.EventOuts	8776	2248
Segment.33.Holdback	8769	2241
Segment.33.RampRate	8773	2245
Segment.33.SegType	8768	2240
Segment.33.TargetSP	8774	2246
Segment.34.CallCycles	8787	2253
Segment.34.CallProg	8786	2252
Segment.34.Duration	8788	2254
Segment.34.EndType	8791	2257
Segment.34.EventOuts	8792	2258
Segment.34.Holdback	8785	2251
Segment.34.RampRate	8789	2255
Segment.34.SegType	8784	2250
Segment.34.TargetSP	8790	2256
Segment.35.CallCycles	8803	2263
Segment.35.CallProg	8802	2262
Segment.35.Duration	8804	2264
Segment.35.EndType	8807	2267
Segment.35.EventOuts	8808	2268
Segment.35.Holdback	8801	2261
Segment.35.RampRate	8805	2265
Segment.35.SegType	8800	2260
Segment.35.TargetSP	8806	2266
Segment.36.CallCycles	8819	2273
Segment.36.CallProg	8818	2272
Segment.36.Duration	8820	2274
Segment.36.EndType	8823	2277
Segment.36.EventOuts	8824	2278
Segment.36.Holdback	8817	2271
Segment.36.RampRate	8821	2275

Version 1.xx Programmer Parameters	DEC	HEX
Segment.36.SegType	8816	2270
Segment.36.TargetSP	8822	2276
Segment.37.CallCycles	8835	2283
Segment.37.CallProg	8834	2282
Segment.37.Duration	8836	2284
Segment.37.EndType	8839	2287
Segment.37.EventOuts	8840	2288
Segment.37.Holdback	8833	2281
Segment.37.RampRate	8837	2285
Segment.37.SegType	8832	2280
Segment.37.TargetSP	8838	2286
Segment.38.CallCycles	8851	2293
Segment.38.CallProg	8850	2292
Segment.38.Duration	8852	2294
Segment.38.EndType	8855	2297
Segment.38.EventOuts	8856	2298
Segment.38.Holdback	8849	2291
Segment.38.RampRate	8853	2295
Segment.38.SegType	8848	2290
Segment.38.TargetSP	8854	2296
Segment.39.CallCycles	8867	22A3
Segment.39.CallProg	8866	22A2
Segment.39.Duration	8868	22A4
Segment.39.EndType	8871	22A7
Segment.39.EventOuts	8872	22A8
Segment.39.Holdback	8865	22A1
Segment.39.RampRate	8869	22A5
Segment.39.SegType	8864	22A0
Segment.39.TargetSP	8870	22A6
Segment.40.CallCycles	8883	22B3
Segment.40.CallProg	8882	22B2
Segment.40.Duration	8884	22B4
Segment.40.EndType	8887	22B7
Segment.40.EventOuts	8888	22B8
Segment.40.Holdback	8881	22B1
Segment.40.RampRate	8885	22B5
Segment.40.SegType	8880	22B0
Segment.40.TargetSP	8886	22B6
Segment.41.CallCycles	8899	22C3
Segment.41.CallProg	8898	22C2
Segment.41.Duration	8900	22C4
Segment.41.EndType	8903	22C7
Segment.41.EventOuts	8904	22C8
Segment.41.Holdback	8897	22C1
Segment.41.RampRate	8901	22C5
Segment.41.SegType	8896	22C0
Segment.41.TargetSP	8902	22C6
Segment.42.CallCycles	8915	22D3
Segment.42.CallProg	8914	22D2
Segment.42.Duration	8916	22D4
Segment.42.EndType	8919	22D7
Segment.42.EventOuts	8920	22D8
Segment.42.Holdback	8913	22D1

Version 1.xx Programmer Parameters	DEC	HEX
Segment.42.RampRate	8917	22D5
Segment.42.SegType	8912	22D0
Segment.42.TargetSP	8918	22D6
Segment.43.CallCycles	8931	22E3
Segment.43.CallProg	8930	22E2
Segment.43.Duration	8932	22E4
Segment.43.EndType	8935	22E7
Segment.43.EventOuts	8936	22E8
Segment.43.Holdback	8929	22E1
Segment.43.RampRate	8933	22E5
Segment.43.SegType	8928	22E0
Segment.43.TargetSP	8934	22E6
Segment.44.CallCycles	8947	22F3
Segment.44.CallProg	8946	22F2
Segment.44.Duration	8948	22F4
Segment.44.EndType	8951	22F7
Segment.44.EventOuts	8952	22F8
Segment.44.Holdback	8945	22F1
Segment.44.RampRate	8949	22F5
Segment.44.SegType	8944	22F0
Segment.44.TargetSP	8950	22F6
Segment.45.CallCycles	8963	2303
Segment.45.CallProg	8962	2302
Segment.45.Duration	8964	2304
Segment.45.EndType	8967	2307
Segment.45.EventOuts	8968	2308
Segment.45.Holdback	8961	2301
Segment.45.RampRate	8965	2305
Segment.45.SegType	8960	2300
Segment.45.TargetSP	8966	2306
Segment.46.CallCycles	8979	2313
Segment.46.CallProg	8978	2312
Segment.46.Duration	8980	2314
Segment.46.EndType	8983	2317
Segment.46.EventOuts	8984	2318
Segment.46.Holdback	8977	2311
Segment.46.RampRate	8981	2315
Segment.46.SegType	8976	2310
Segment.46.TargetSP	8982	2316
Segment.47.CallCycles	8995	2323
Segment.47.CallProg	8994	2322
Segment.47.Duration	8996	2324
Segment.47.EndType	8999	2327
Segment.47.EventOuts	9000	2328
Segment.47.Holdback	8993	2321
Segment.47.RampRate	8997	2325
Segment.47.SegType	8992	2320
Segment.47.TargetSP	8998	2326
Segment.48.CallCycles	9011	2333
Segment.48.CallProg	9010	2332
Segment.48.Duration	9012	2334
Segment.48.EndType	9015	2337
Segment.48.EventOuts	9016	2338

Version 1.xx Programmer Parameters	DEC	HEX
Segment.48.Holdback	9009	2331
Segment.48.RampRate	9013	2335
Segment.48.SegType	9008	2330
Segment.48.TargetSP	9014	2336
Segment.49.CallCycles	9027	2343
Segment.49.CallProg	9026	2342
Segment.49.Duration	9028	2344
Segment.49.EndType	9031	2347
Segment.49.EventOuts	9032	2348
Segment.49.Holdback	9025	2341
Segment.49.RampRate	9029	2345
Segment.49.SegType	9024	2340
Segment.49.TargetSP	9030	2346
Segment.50.CallCycles	9043	2353
Segment.50.CallProg	9042	2352
Segment.50.Duration	9044	2354
Segment.50.EndType	9047	2357
Segment.50.EventOuts	9048	2358
Segment.50.Holdback	9041	2351
Segment.50.RampRate	9045	2355
Segment.50.SegType	9040	2350
Segment.50.TargetSP	9046	2356

28. Appendix E Safety and EMC Information

Eurotherm Controls Ltd manufactures this controller in the UK.

Please read this section carefully before installing the controller

This controller is intended for industrial temperature and process control applications where it will meet the requirements of the European Directives on Safety and EMC. If the instrument is used in a manner not specified in this manual, the safety or EMC protection provided by the instrument may be impaired. The installer must ensure the safety and EMC of any particular installation.

The Mini8 controller is intended for operation at safe low voltage levels, except the RL8 relay module. Voltages in excess of 42 volts must not be applied to any terminals other than the RL8 relay module.

Protective Earth Connection is required.

Safety

This controller complies with the European Low Voltage Directive 2006/95/EC, by the application of the safety standard EN 61010. The earth stud should be connected to safety earth before other connections are made.

Electromagnetic compatibility

This controller conforms with the essential protection requirements of the EMC Directive 2004/108/EC, by the application of EMC standard EN61326

Unpacking and storage

The packaging should contain an instrument and an Installation guide. It may contain a CD.

If on receipt, the packaging or the instrument is damaged, do not install the product but contact your supplier.

If the instrument is to be stored before use, protect it from humidity and dust in an ambient temperature range of -10°C to +70°C.

SERVICE AND REPAIR

This controller has no user serviceable parts. Contact your supplier for repair.

Cleaning

Do not use water or water based products to clean labels or they will become illegible. Isopropyl alcohol may be used to clean labels. A mild soap solution may be used to clean other exterior surfaces of the product.

GENERAL

The information contained in this manual is subject to change without notice. While every effort has been made to ensure the accuracy of the information, your supplier shall not be held liable for errors contained herein.

INSTALLATION SAFETY REQUIREMENTS

Safety Symbols

Various symbols are used on the instrument, they have the following meaning:



Caution (refer to the accompanying documents)



Protective Conductor Terminal

Personnel

Installation must only be carried out by suitably qualified personnel.

Mounting

The Mini8 controller should be mounted in a suitable enclosure with suitable ventilation to ensure the ambient temperature remains below 50°C.

Wiring

It is important to connect the controller in accordance with the wiring data given in this guide. Take particular care not to connect AC supplies to the low voltage sensor input or other low level inputs and outputs. Only use copper conductors for connections (except thermocouple inputs) and ensure that the wiring of installations comply with all local wiring regulations. For example in the UK use the latest version of the IEE wiring regulations, (BS7671). In the USA use NEC Class 1 wiring methods.

Power Isolation

The installation must include a power isolating switch or circuit breaker. The device should be mounted in close proximity to the controller, within easy reach of the operator and marked as the disconnecting device for the instrument.

Overcurrent protection

The power supply to the system should be fused appropriately to protect the cabling to the units.

Voltage rating

The maximum continuous voltage applied between any of the following terminals must not exceed:

- 24 V dc \pm 10% on the power supply terminals
- 42V peak on analogue and digital I/O terminals, and fixed resource I/O terminals;
- 264V rms on Relay card fitted in I/O slot 2 or 3.

The case MUST be wired to a protective earth.

Conductive pollution

Electrically conductive pollution must be excluded from the cabinet in which the controller is mounted. For example, carbon dust is a form of electrically conductive pollution. To secure a suitable atmosphere, install an air filter to the air intake of the cabinet. Where condensation is likely, for example at low temperatures, include a thermostatically controlled heater in the cabinet.

This product has been designed to conform to BSEN61010 installation category II, pollution degree 2. These are defined as follows:-

Installation Category II

The rated impulse voltage for equipment on nominal 24V dc supply is 800V.

Pollution Degree 2

Normally only non conductive pollution occurs. Occasionally, however, a temporary conductivity caused by condensation shall be expected.

Over-Temperature Protection

When designing any control system it is essential to consider what will happen if any part of the system should fail. In temperature control applications the primary danger is that the heating will remain constantly on. Apart from spoiling the product, this could damage any process machinery being controlled, or even cause a fire.

Reasons why the heating might remain constantly on include:

- the temperature sensor becoming detached from the process
- thermocouple wiring becoming short circuit;
- the controller failing with its heating output constantly on
- an external valve or contactor sticking in the heating condition
- the controller setpoint set too high.

Where damage or injury is possible, we recommend fitting a separate over-temperature protection unit, with an independent temperature sensor, which will isolate the heating circuit.

Please note that the alarm relays within the controller will not give protection under all failure conditions.

INSTALLATION REQUIREMENTS FOR EMC

To ensure compliance with the European EMC directive certain installation precautions are necessary as follows:

- For general guidance refer to EMC Installation Guide, HA025464.
- When using relay outputs it may be necessary to fit a filter suitable for suppressing the conducted emissions. The filter requirements will depend on the type of load.
- If the unit is used in table top equipment which is plugged into a standard power socket, then it is likely that compliance to the commercial and light industrial emissions standard is required. In this case to meet the conducted emissions requirement, a suitable mains filter should be installed.

Routing of wires

To minimise the pick-up of electrical noise, the low voltage DC connections and the sensor input wiring should be routed away from high-current power cables. Where it is impractical to do this, use shielded cables with the shield grounded at both ends. In general keep cable lengths to a minimum.

29. Appendix F Technical Specification

The I/O electrical specifications are quoted as factory calibrated worst-case; for life, over full ambient temperature range and supply voltage. Any "typical" figures quoted are the expected values at 25°C ambient and 24Vdc supply.

The nominal update of all inputs and function blocks is every 110ms. However, in complex applications the Mini8 controller will automatically extend this time in multiples of 110ms.

29.1 Environmental Specification

Power Supply Voltage	17.8Vdc min to 28.8Vdc max.
Supply Ripple	2Vp-p max.
Power Consumption	15W max.
Operating Temperature	0 to 55°C
Storage Temperature	-10°C to +70°C
Operating Humidity	5% to 95% RH non-condensing
EMC	EN61326 for Industrial Environments
Safety	Meets EN61010, installation category II, pollution degree 2.
Max. applied voltage any terminal	42Vpk.
The Mini8 controller must be mounted in a protective enclosure.	

29.2 Network Communications Support

Modbus RTU: RS485, 2 x RJ45, user select switch for 3-wire or 5-wire.	Baud rates: 4800, 9600, 19200
DeviceNet: CAN, 5-pin standard "open connector" with screw terminals.	Baud rates: 125k, 250k, 500k
CANopen: CAN, 5-pin standard "open connector" with screw terminals.	Baud rates: 125k, 250k, 500k, 1M
Profibus DP: RS485 via standard 9 pin D connectopr OR 2 RJ45 connectors	Baud rates: Up to 12M set by the Master
EtherNet: Standard EtherNet RJ45 connector.	Baud rate: 10baseT
EtherNet/IP: Standard EtherNet RJ45 connector.	Baud rates: 10baseT 100baseT
Modbus /DeviceNet /CANopen /Profibus /EtherNet/EtherNet/IP are mutually exclusive options; refer to the Mini8 controller order code document.	

29.3 Configuration Communications Support

Modbus RTU: 3-wire RS232, through RJ11 configuration port.	Baud rates: 4800, 9600, 19200
All versions of Mini8 controller support one configuration port. The configuration port can be used simultaneously with the network link.	

29.4 Fixed I/O Resources

The PSU card supports 2 independent and isolated relay contacts	
Relay Output Types	On/Off (C/O contacts, "On" closing the N/O pair)
Contact Current	<1A (resistive loads)
Terminal Voltage	<42Vpk
Contact Material	Gold
Snubbers	Snubber networks are NOT fitted.
Contact Isolation	42Vpkmax.
The PSU card supports 2 independent and isolated logic inputs	
Input Types	Logic (24Vdc)
Input Logic 0 (off)	-28.8V to + 5Vdc.
Input Logic 1 (on)	+10.8V to +28.8Vdc.
Input Current	2.5mA (approx.) at 10.8V; 10mA max at 28.8V supply.
Detectable Pulse Width	110ms min.
Isolation to system	42Vpkmax.

29.5 TC8 8-Channel and TC4 4-Channel TC Input Card

The TC8 supports 8 independently programmable and electrically isolated channels, catering for all standard and custom thermocouple types. The TC4 supports 4 channels to the same specification.

Channel Types	TC, mV Input Range: -77mV to +77mV.
Resolution	20 bit ($\Sigma\Delta$ converter), 1.6 μ V with 1.6s filter time
Temperature Coefficient	< ± 50 ppm (0.005%) of reading/ $^{\circ}$ C
Cold Junction Range	-10 $^{\circ}$ C to +70 $^{\circ}$ C
CJ Rejection	> 30:1
CJ Accuracy	$\pm 1^{\circ}$ C
Linearisation Types	C, J, K, L, R, B, N, T, S, LINEAR mV, custom.
Total accuracy	$\pm 1^{\circ}$ C $\pm 0.1\%$ of reading (using internal CJC)
Channel PV Filter	0.0 seconds (off) to 999.9 seconds, 1st order low-pass.
Sensor Break: AC detector	Off, Low or High resistance trip levels.
Input Resistance	>100 M
Input Leakage Current	<100nA (1nA typical).
Common mode rejection	>120dB, 47 - 63Hz
Series mode rejection	>60dB, 47 - 63Hz
Isolation channel-channel	42Vpkmax
Isolation to system	42Vpkmax

29.6 DO8 8-Channel Digital Output Card

The DO8 supports 8 independently programmable channels, the output switches requiring external power supply. Each channel is current and temperature protected, foldback limiting occurring at about 100mA.

The supply line is protected to limit total card current to 200mA.

The 8 channels are isolated from the system (but not from each other). To maintain isolation it is essential to use an independent and isolated PSU.

Channel Types	On/Off, Time Proportioned
Channel Supply (Vcs)	15Vdc to 30Vdc
Logic 1 Voltage Output	> (Vcs - 3V) (not in power limiting)
Logic 0 Voltage Output	< 1.2Vdc no-load, 0.9V typical
Logic 1 Current Output	100mA max. (not in power limiting)
Min. Pulse Time	20ms
Channel Power Limiting	Current limiting capable of driving short-circuit load
Terminal Supply Protection	Card supply is protected by 200mA self-healing fuse
Isolation (channel-channel)	N/A (Channels share common connections)
Isolation to system	42Vpk max.

29.7 RL8 8-Channel Relay Output Card

The RL8 supports 8 independently programmable channels. This module may only be fitted in slot 2 or 3, giving a maximum of 16 relays in a Mini8 controller.

The Mini8 controller chassis must be earthed (grounded) using the protective earth stud.

Channel Types	On/Off, Time Proportioned	
Maximum contact voltage	264 volt ac	
Maximum contact current	2 amps ac	
Contact snubber	Fitted on module	
Minimum contact wetting	5 volt dc, 10mA	
Min. Pulse Time	220ms	
Isolation (channel-channel)	264V	230V nominal
Isolation to system	264V.	

29.8 CT3 3-Channel Current-Transformer Input Card

The CT3 supports 3 independent channels designed for heater current monitoring. A scan block allows periodic test of nominated outputs to detect load (failure) changes.

Channel Types	A (current)
Factory set accuracy	better than $\pm 2\%$ of range
Current Input Range	0mA to 50mA rms, 50/60Hz nominal
Transformer Ratio	10/0.05 to 1000/0.05
Input Load Burden	1W
Isolation	None (provided by CT)

29.9 Load Failure Detection

Requires CT3 module	
Max number of loads	16 Time Proportioned Outputs
Max loads per CT	6 loads per CT input
Alarms	1 in 8 Partial load failure, Over current, SSR short circuit, SSR open circuit
Commissioning	Automatic or manual
Measurement interval	1 sec - 60 sec

29.10 DI8 8-Channel Digital Input Card

The DI8 supports 8 independent input channels.

Input Types	Logic (24Vdc)
Input Logic 0 (off)	-28.8V to +5Vdc.
Input Logic 1 (on)	+10.8V to +28.8Vdc.
Input Current	2.5mA (approx.) at 10.8V; 10mA max at 28.8V supply.
Detectable Pulse Width	110ms min.
Isolation channel-channel	42Vpkmax
Isolation to system	42Vpkmax.

29.11 RT4 Resistance Thermometer Input Card

The RT4 supports 4 independently programmable and electrically isolated resistance input channels. Each channel may connected as 2 wire, 3 wire or 4 wire.

Channel Types	Resistance/PT100
Input Range	0 to 600 ohms, -200°C to +850°C for PT100
Calibration Error	± 0.1 ohms $\pm 0.1\%$ of reading, 22 to 500 ohms ± 0.3 °C $\pm 0.1\%$ of reading, -200°C to +850°C
Resolution	0.008 ohms, 0.2°C
Measurement Noise	0.016 ohms, 0.04°C peak to peak, 1.6s channel filter 0.06 ohms, 0.15°C peak to peak, no filter
Linearity error	± 0.02 ohms, ± 0.05 °C
Temp coefficient	$\pm 0.002\%$ of ohms reading per °C ambient change relative to normal ambient 25°C
Lead resistance	22 ohms max in each leg. Total resistance including leads is restricted to the 600 ohm maximum limit. 3 wire connection assumed matched leads.
Bulb current	300 μ A
Isolation channel-channel	42Vpkmax
Isolation to system	42Vpkmax

29.12 AO8 8-Channel and AO4 4-Channel 4-20mA Output Card

The AO8 supports 8 independently programmable and electrically isolated mA output channels for 4-20mA current-loop applications. The AO4 supports 4 channels to the same specification. The AO4 and AO8 modules may only be fitted in slot 4.

Channel Types	mA (current) Output
Output Range	0-20mA, 360Ω load max.
Setting Accuracy	±0.5% of reading
Resolution	1 part in 10000 (1uA typical)
Isolation channel-channel	42Vpkmax
Isolation to system	42Vpkmax

29.13 Toolkit Blocks

User Wires	Orderable options of 30, 60 120 or 250	
User values	32 real values	
2 Input Maths	24 blocks	Add, subtract, multiply, divide, absolute difference, maximum, minimum, hot swap, sample and hold, power, square root, Log, Ln, exponential, switch
2 Input Logic	24 blocks	AND, OR, XOR, latch, equal, not equal, greater than, less than, greater than or equal to, less than or equal to
8 Input Logic	4 blocks	AND, OR, XOR
8 Input Multiple Operator	4 blocks	Maximum, Minimum, Average. Input/Outputs to allow cascading of blocks
8 Input Multiplexer	4 blocks	8 sets of 8 values selected by input parameter
BCD Input	2 blocks	2 decades (8 inputs giving 0 to 99).
Input monitor	2 blocks	Max, min, time above threshold
16 Point Linearisation	2 blocks	16-point linearisation fit
Polynomial Fit	2 blocks	Characterisation by Poly Fit table
Switchover	1 block	Smooth transition between two input values
Timer blocks	8 blocks	OnPulse, OnDelay, OneShot, MinOn Time
Counter blocks	2 blocks	Up or down, Directional flag
Totaliser blocks	2 blocks	Alarm at Threshold value
Real time clock	1 block	Day & time, 2 time based alarms
Transducer Scaling	2 blocks	Transducer Auto-tare, calibration & comparison cal.

29.14 PID Control Loop Blocks

Number of Loops	0, 4, 8 or 16 Loops (order options)
Control modes	On/Off, single PID, Dual channel OP
Control Outputs	Analogue 4-20mA, Time proportioned logic
Cooling algorithms	Linear, water, fan, or oil
Tuning	3 sets PID, One-shot auto-tune.
Auto manual control	Bumpless transfer or forced manual output available
Setpoint rate limit	Ramp in units per sec, per min or per hour.
Output rate limit	Ramp in % change per second
Other features	Feedforward, Input track, Sensor break OP, Loop break alarm, remote SP, 2 internal loop setpoints

29.15 Process Alarms

Number of alarms	32 analogue, 32 digital, 32 Sensor break
Alarm types	Absolute high, absolute low, deviation high, deviation low, deviation band, sensor break, logic high, logic low, rising edge, falling edge, edge
Alarm modes	Latching or non-latching, blocking, time delay

29.16 Setpoint Programmer

The Setpoint Programmer is a software orderable option	
Number of programs	8
Number of segments	128
Number of event outputs	8 per program (64 total)
Digital inputs	Run, Hold, Reset, Run/Hold, Run/Reset, Program Advance, Skip, Segment, Sync
Power failure action	Ramp, Reset, Continue
Servo start	PV, SP

29.17 Recipes

Recipes are a software orderable option	
Number of recipes	8
Tags	24 tags in total

30. Parameter Index

Parameter	Folder	Section	Parameter	Folder	Section
Ack	Analogue alarms	8.5	Ch2 OnOff Hysteresis	Output function block	17.7
Ack	Digital alarms	8.6	Ch2 Out	Output function block	17.7
Active Set	Loop PID	17.4.10	CJC Temp	IO - Thermocouple input	7.5.1
ActiveOut	Loop - main	17.2	CJC Type	IO - Thermocouple input	7.5.1
Address	Comms - CC (config)	10.1.1	CleanFreq	Zirconia	12.2.8
Address	Comms - Modbus	10.4.2	CleanProbe	Zirconia	12.2.8
Address	Comms - Devicenet	10.7.1	CleanState	Zirconia	12.2.8
Address	Comms - Profibus	10.9.1	CleanTime	Zirconia	12.2.8
Address	Comms - EtherNet	10.10.5	CleanValve	Zirconia	12.2.8
AdvSeg	Programmer - Setup	18.1	Clear Cal	Transducer scaling	20.4
Alarm SP	Totaliser	11.3.1	Clear Log	Instrument - Diagnostics	6.4
AlarmAck	IO - Thermocouple input	7.5.1	Clear Overflow	Counter	11.1.1
AlarmAck	IO - PRT input	7.6.1	Clear Stats	Instrument - Diagnostics	6.4
AlarmDays	Input monitor	13.2	ClearLog	Alarm log	8.8
AlarmEn1	Instrument - Enables	6.1	ClearMemory	Access	5.0
AlarmEn2	Instrument - Enables	6.1	Clock	Counter	11.1.1
AlarmEn3	Instrument - Enables	6.1	CntrlOverrun	Instrument - Diagnostics	6.4
AlarmEn4	Instrument - Enables	6.1	Commission	IO - Current monitor	7.9.4
AlarmOut	Totaliser	11.3.1	CommissionStatus	IO - Current monitor	7.9.4
AlarmTime	Input monitor	13.2	CommsStack	Instrument - Diagnostics	6.4
Alt SP	Setpoint	17.6.5	CompanyID	Instrument - InstInfo	6.3
Alt SP Select	Setpoint	17.6.5	Control Action	Loop set up	17.3
AnAlarmStatus1	Alarm summary	8.7	Cool Type	Output function block	17.7
AnAlarmStatus2	Alarm summary	8.7	Count	Counter	11.1.1
AnAlarmStatus3	Alarm summary	8.7	CounterEn	Instrument - Enables	6.1
AnAlarmStatus4	Alarm summary	8.7	CPUFree	Instrument - Diagnostics	6.4
AnyAlarm	Alarm summary	8.7	CT1Range*	IO - Current monitor	7.9.4
Attenuation	Load	16.1	CT2Range*	IO - Current monitor	7.9.4
AutoMan	Loop - main	17.2	CT3Range*	IO - Current monitor	7.9.4
AutoTune Enable	Loop tune	17.5.5	CTAlarmStatus1	Alarm summary	8.7
Average Out	Multi operators	14.4.3	CTAlarmStatus2	Alarm summary	8.7
Baud	Comms - CC (config)	10.1.1	CTAlarmStatus3	Alarm summary	8.7
Baud	Comms - Modbus	10.4.2	CTAlarmStatus4	Alarm summary	8.7
Baud	Comms - Devicenet	10.7.1	CtrlStack	Instrument - Diagnostics	6.4
BCD Value	BCD Input	9.1	CtrlTicks	Instrument - Diagnostics	6.4
BCDInEn	Instrument - Enables	6.1	CurProg	Programmer - Run Status	18.1
Block	Analogue alarms	8.5	CurrentMon	Instrument - Enables	6.1
Block	Digital alarms	8.6	CurrSeg	Programmer - Run Status	18.1
Boundary 1-2	Loop PID	17.4.10	CurSegType	Programmer - Run Status	18.1
Boundary 2-3	Loop PID	17.4.10	Cust1Name	Instrument - Diagnostics	6.4
Broadcast Address	Comms - Modbus	10.4.2	Cust2Name	Instrument - Diagnostics	6.4
Broadcast Enabled	Comms - Modbus	10.4.2	Cust3Name	Instrument - Diagnostics	6.4
Broadcast Value	Comms - Modbus	10.4.2	CustomerID	Access	5.0
Cal Active	Transducer scaling	20.4	CutbackHigh 1, 2, 3	Loop PID	17.4.10
Cal Band	Transducer scaling	20.4	CutbackLow 1, 2, 3	Loop PID	17.4.10
Cal Enable	Transducer scaling	20.4	CyclesLeft	Programmer - Run Status	18.1
Cal State	IO - Thermocouple input	7.5.1	CyclesLeft	Programmer - Run Status	18.1
Cal State	IO - PRT input	7.6.1	Day	Real time clock	11.4
Cal State	Calibration	22.5	Days Above	Input monitor	13.2
Cal Status	Transducer scaling	20.4	Dec Value	BCD Input	9.1
Cal Type	Transducer scaling	20.4	Default Gateway 1	Comms - EtherNet	10.10.5
CalAdjust	Transducer scaling	20.4	Default Gateway 2	Comms - EtherNet	10.10.5
CalibrateCT1	IO - Current monitor	7.9.4	Default Gateway 3	Comms - EtherNet	10.10.5
CalibrateCT2	IO - Current monitor	7.9.4	Default Gateway 4	Comms - EtherNet	10.10.5
CalibrateCT3	IO - Current monitor	7.9.4	Delay	Analogue alarms	8.5
CarbonPot	Zirconia	12.2.8	Delay	Digital alarms	8.6
Cascln	Multi operators	14.4.3	DelayedStart	Programmer - Setup	18.1
CascNumln	Multi operators	14.4.3	DelayedStart	Programmer - Run Status	18.1
Ch 1 ControlType	Loop set up	17.3	Derivative	Loop set up	17.3
Ch 2 Gain	Load	16.1	DerivativeTime 1, 2, 3	Loop PID	17.4.10
Ch1 OnOff Hysteresis	Output function block	17.7	Destination	Comms - SCADA Table	24.1
Ch1 Out	Output function block	17.7	DewPoint	Humidity	12.1.4
Ch2 ControlType	Loop set up	17.3	DewPoint	Zirconia	12.2.8
Ch2 DeadBand	Output function block	17.7	DHCP enable	Comms - EtherNet	10.10.5
			DigAlarmStatus1	Alarm summary	8.7
			DigAlarmStatus2	Alarm summary	8.7

Parameter	Folder	Section	Parameter	Folder	Section
DigAlarmStatus3	Alarm summary	8.7	FallbackType	Input linearisation	15.1.2
DigAlarmStatus4	Alarm summary	8.7	FallbackValue	Polynomial	15.2
DigAlmEn1	Instrument - Enables	6.1	FastRun	Programmer - Run Status	18.1
DigAlmEn2	Instrument - Enables	6.1	FeedForward Gain	Output function block	17.7
DigAlmEn3	Instrument - Enables	6.1	FeedForward Offset	Output function block	17.7
DigAlmEn4	Instrument - Enables	6.1	FeedForward Trim Limit	Output function block	17.7
Direction	Counter	11.1.1	FeedForward Type	Output function block	17.7
Disp Hi	IO - Analogue output	7.7	FeedForward Val	Output function block	17.7
Disp Lo	IO - Analogue output	7.7	FF_Rem	Output function block	17.7
DisplayHigh	IO - Logic output	7.3.1	Filter Time Constant	IO - Thermocouple input	7.5.1
DisplayHigh	IO - Relay output	7.4.1	Filter Time Constant	IO - PRT input	7.6.1
DisplayHigh	IO - Thermocouple input	7.5.1	ForcedOP	Output function block	17.7
DisplayLow	IO - Logic output	7.3.1	Friday	Real time clock	11.4
DisplayLow	IO - Relay output	7.4.1	Gain	Load	16.1
DisplayLow	IO - Thermocouple input	7.5.1	GasRef	Zirconia	12.2.8
DryTemp	Humidity	12.1.4	GlobalAck	Alarm summary	8.7
Elapsed Time	Timer	11.2.6	Goback CyclesLeft	Programmer - Run Status	18.1
Enable	Counter	11.1.1	High Limit	User values	21.1
Enable	Programmer - Setup	18.1	HighLimit	Maths operators	14.3.2
Enable	Programmer - Setup	18.1	HighLimit	Mux8 operators	14.5.1
EnableGsoak	Programmer - Setup	18.1	HiOffset	IO - Thermocouple input	7.5.1
EnablelmmPSP	Programmer - Setup	18.1	HiOffset	IO - PRT input	7.6.1
EnablePVevent	Programmer - Setup	18.1	HiPoint	IO - Thermocouple input	7.5.1
EnableTime	Programmer - Setup	18.1	HiPoint	IO - PRT input	7.6.1
EnableUserVal	Programmer - Setup	18.1	Hold	Totaliser	11.3.1
End of Seg	Programmer - Setup	18.1	HumidityEn	Instrument - Enables	6.1
EndOutput	Programmer - Run Status	18.1	Hysteresis	Analogue alarms	8.5
Entry1Day	Alarm log	8.8	Ident	IO - Logic input	7.2.1
Entry1Ident	Alarm log	8.8	Ident	IO - Logic output	7.3.1
Entry1Time	Alarm log	8.8	Ident	IO - Relay output	7.4.1
Entry2Day	Alarm log	8.8	Ident	IO - Thermocouple input	7.5.1
Entry2Ident	Alarm log	8.8	Ident	IO - PRT input	7.6.1
Entry2Time	Alarm log	8.8	Ident	IO - Analogue output	7.7
Entry32Day	Alarm log	8.8	Ident	IO - Fixed IO	7.8
Entry32Ident	Alarm log	8.8	Ident	Comms - CC (config)	10.1.1
Entry32Time	Alarm log	8.8	Ident	Comms - Modbus	10.4.2
Err1	Instrument - Diagnostics	6.4	Ident	Comms - Devicenet	10.7.1
Err2	Instrument - Diagnostics	6.4	Ident	Comms - Profibus	10.9.1
Err3	Instrument - Diagnostics	6.4	Ident	Comms - EtherNet	10.10.5
Err4	Instrument - Diagnostics	6.4	IdleStack	Instrument - Diagnostics	6.4
Err5	Instrument - Diagnostics	6.4	In	Analogue alarms	8.5
Err6	Instrument - Diagnostics	6.4	In	Digital alarms	8.6
Err7	Instrument - Diagnostics	6.4	In	Timer	11.2.6
Err8	Instrument - Diagnostics	6.4	In	Totaliser	11.3.1
ErrCount	Instrument - Diagnostics	6.4	In	Input monitor	13.2
ErrMode	Switch over	19.1	In	Input linearisation	15.1.2
EtherNet Status	Comms - EtherNet	10.10.5	In	Polynomial	15.2
Event	Programmer - Setup	18.1	In 1	BCD Input	9.1
EventOut1 to 8	Programmer - Setup	18.1	In 1 to In 8	Multi operators	14.4.3
EventsOut	Programmer - Run Status	18.1	In 2	BCD Input	9.1
Everyday	Real time clock	11.4	In 3	BCD Input	9.1
Fallback	IO - Thermocouple input	7.5.1	In 4	BCD Input	9.1
Fallback	IO - PRT input	7.6.1	In 5	BCD Input	9.1
Fallback	Maths operators	14.3.2	In 6	BCD Input	9.1
Fallback	Mux8 operators	14.5.1	In 7	BCD Input	9.1
Fallback PV	IO - Thermocouple input	7.5.1	In 8	BCD Input	9.1
Fallback PV	IO - PRT input	7.6.1	In Status	Input monitor	13.2
Fallback Typ	Multi operators	14.4.3	In1	Logic operators	14.1.3
Fallback Type	Polynomial	15.2	In1	Maths operators	14.3.2
Fallback Type	Switch over	19.1	In1	Switch over	19.1
Fallback Val	Maths operators	14.3.2	In1 to 8	Mux8 operators	14.5.1
Fallback Val	Multi operators	14.4.3	In1 to In14	Input linearisation	15.1.2
Fallback Val	Mux8 operators	14.5.1	In1 to In8	Input operators	14.2
Fallback Value	Input linearisation	15.1.2	In1Mul	Maths operators	14.3.2
Fallback Value	Switch over	19.1	In2	Logic operators	14.1.3
FallbackType	Logic operators	14.1.3	In2	Maths operators	14.3.2

MINI8 CONTROLLER: ENGINEERING HANDBOOK

Parameter	Folder	Section	Parameter	Folder	Section
In2	Switch over	19.1	MAC4	Comms - EtherNet	10.10.5
In2 Mul	Maths operators	14.3.2	MAC5	Comms - EtherNet	10.10.5
Inhibit	IO - Current monitor	7.9.4	MAC6	Comms - EtherNet	10.10.5
Inhibit	Analogue alarms	8.5	Manual Mode	Output function block	17.7
Inhibit	Digital alarms	8.6	ManualOutVal	Output function block	17.7
Inhibit	Loop - main	17.2	ManualReset 1, 2, 3	Loop PID	17.4.10
InHigh	Switch over	19.1	ManualTrack	Setpoint	17.6.5
InHigh	Transducer scaling	20.4	Math2 En1	Instrument - Enables	6.1
InHighLimit	Input linearisation	15.1.2	Math2 En2	Instrument - Enables	6.1
InHighScale	Polynomial	15.2	Math2 En3	Instrument - Enables	6.1
InInvert	Input operators	14.2	Max	Input monitor	13.2
InLow	Switch over	19.1	Max Con Tick	Instrument - Diagnostics	6.4
InLow	Transducer scaling	20.4	Max Events	Programmer - Setup	18.1
InLowLimit	Input linearisation	15.1.2	Max Out	Multi operators	14.4.3
InLowScale	Polynomial	15.2	Max segments	Instrument - Diagnostics	6.4
InputSize	EtherNet IP	10.11.3	MaxLeakPh1	IO - Current monitor	7.9.4
Input Status	Multi operators	14.4.3	MaxLeakPh2	IO - Current monitor	7.9.4
InstType	Instrument - InstInfo	6.3	MaxLeakPh3	IO - Current monitor	7.9.4
IntegralTime 1, 2, 3	Loop PID	17.4.10	MaxRcovTime	Zirconia	12.2.8
Interval	IO - Current monitor	7.9.4	MaxSegsPerProg	Instrument - Diagnostics	6.4
IntHold	Loop - main	17.2	Meas Value	IO - Analogue output	7.7
InVal	Transducer scaling	20.4	Measured Val	IO - Logic input	7.2.1
Invert	IO - Logic input	7.2.1	Measured Val	IO - Thermocouple input	7.5.1
Invert	IO - Logic output	7.3.1	Measured Val	IO - PRT input	7.6.1
Invert	IO - Relay output	7.4.1	Measured Val	IO - Fixed IO	7.8
Invert	IO - Fixed IO	7.8	MeasuredVal	IO - Logic output	7.3.1
Invert	Logic operators	14.1.3	MeasuredVal	IO - Relay output	7.4.1
IO Type	IO - Thermocouple input	7.5.1	Min	Input monitor	13.2
IO Type	IO - PRT input	7.6.1	Min Out	Multi operators	14.4.3
IO Type	IO - Analogue output	7.7	MinCalTemp	Zirconia	12.2.8
IO Type	IO - Fixed IO	7.8	MinCPUFree	Instrument - Diagnostics	6.4
IOType	IO - Logic input	7.2.1	MinOnTime	IO - Logic output	7.3.1
IOType	IO - Logic output	7.3.1	MinOnTime	IO - Relay output	7.4.1
IOType	IO - Relay output	7.4.1	MinRcovTime	Zirconia	12.2.8
IP Address 1	Comms - EtherNet	10.10.5	Minutes	Comms - SCADA Table	24.1
IP Address 2	Comms - EtherNet	10.10.5	Mode	Real time clock	11.4
IP Address 3	Comms - EtherNet	10.10.5	Module1	IO - ModIDs	7.1
IP Address 4	Comms - EtherNet	10.10.5	Module2	IO - ModIDs	7.1
IP Mon En	Instrument - Enables	6.1	Module3	IO - ModIDs	7.1
Latch	Analogue alarms	8.5	Module4	IO - ModIDs	7.1
Latch	Digital alarms	8.6	Monday	Real time clock	11.4
Lgc2 En1	Instrument - Enables	6.1	Mon-Fri	Real time clock	11.4
Lgc2 En2	Instrument - Enables	6.1	Mon-Sat	Real time clock	11.4
Lgc2 En3	Instrument - Enables	6.1	MultiOperEn	Instrument - Enables	6.1
Lgc8 En	Instrument - Enables	6.1	Mux8 En	Instrument - Enables	6.1
Lin Type	IO - Thermocouple input	7.5.1	Native	Comms - SCADA Table	24.1
Lin Type	IO - PRT input	7.6.1	Network Status	Comms - Profibus	10.9.1
Lin16Pt En	Instrument - Enables	6.1	Never	Real time clock	11.4
LinType	Polynomial	15.2	NewAlarm	Alarm summary	8.7
Load En	Instrument - Enables	6.1	NewCTAlarm	Alarm summary	8.7
Load En2	Instrument - Enables	6.1	Noise	Load	16.1
LoOffset	IO - Thermocouple input	7.5.1	Num Sets	Loop PID	17.4.10
LoOffset	IO - PRT input	7.6.1	NumIn	Input operators	14.2
Loop En	Instrument - Enables	6.1	NumIn	Multi operators	14.4.3
Loop En2	Instrument - Enables	6.1	NumValidIn	Multi operators	14.4.3
LoopBreakTime 1, 2, 3	Loop PID	17.4.10	Off Day1 & 2	Real time clock	11.4
LoopOutCh1	Load	16.1	Off Time1 & 2	Real time clock	11.4
LoopOutCh2	Load	16.1	Offset	IO - Thermocouple input	7.5.1
LoPoint	IO - Thermocouple input	7.5.1	Offset	IO - PRT input	7.6.1
LoPoint	IO - PRT input	7.6.1	Offset	Load	16.1
Low Limit	User values	21.1	On Day1 & 2	Real time clock	11.4
LowLimit	Maths operators	14.3.2	On Time1 & 2	Real time clock	11.4
LowLimit	Mux8 operators	14.5.1	Oper	Logic operators	14.1.3
MAC1	Comms - EtherNet	10.10.5	Oper	Input operators	14.2
MAC2	Comms - EtherNet	10.10.5	Oper	Maths operators	14.3.2
MAC3	Comms - EtherNet	10.10.5	Out	Analogue alarms	8.5

MINI8 CONTROLLER: ENGINEERING HANDBOOK

Parameter	Folder	Section	Parameter	Folder	Section
Out	Digital alarms	8.6	PSP	Programmer - Run Status	18.1
Out	Timer	11.2.6	PSUident	Instrument - Diagnostics	6.4
Out	Input monitor	13.2	Psychro Const	Humidity	12.1.4
Out	Logic operators	14.1.3	PV	IO - Logic input	7.2.1
Out	Input operators	14.2	PV	IO - Logic output	7.3.1
Out	Maths operators	14.3.2	PV	IO - Relay output	7.4.1
Out	Mux8 operators	14.5.1	PV	IO - Thermocouple input	7.5.1
Out	Input linearisation	15.1.2	PV	IO - PRT input	7.6.1
Out	Polynomial	15.2	PV	IO - Analogue output	7.7
Out	Switch over	19.1	PV	IO - Fixed IO	7.8
Out Invert	Input operators	14.2	PV	Loop - main	17.2
Out1 & 2	Real time clock	11.4	PV Out1	Load	16.1
Out1 to Out14	Input linearisation	15.1.2	PV Out2	Load	16.1
OutHi Limit	Multi operators	14.4.3	PVFault	Load	16.1
OutHighLimit	Input linearisation	15.1.2	PvFrozen	Zirconia	12.2.8
OutHighScale	Polynomial	15.2	PVIn	Programmer - Setup	18.1
OutLo Limit	Multi operators	14.4.3	PwrFailCount	Instrument - Diagnostics	6.4
OutLowLimit	Input linearisation	15.1.2	Range Hi	IO - Analogue output	7.7
OutLowScale	Polynomial	15.2	Range High	Setpoint	17.6.5
Output High Limit	Output function block	17.7	Range Lo	IO - Analogue output	7.7
Output Low Limit	Output function block	17.7	Range Low	Setpoint	17.6.5
OutputHi 1, 2, 3	Loop PID	17.4.10	Range Max	Transducer scaling	20.4
OutputHigh Limit	Loop tune	17.5.5	Range Min	Transducer scaling	20.4
OutputLo 1, 2, 3	Loop PID	17.4.10	RangeHigh	IO - Logic output	7.3.1
OutputLow Limit	Loop tune	17.5.5	RangeHigh	IO - Relay output	7.4.1
OutputSize	EtherNet IP	10.11.3	RangeHigh	IO - Thermocouple input	7.5.1
OutVal	Transducer scaling	20.4	RangeLow	IO - Logic output	7.3.1
Overflow	Counter	11.1.1	RangeLow	IO - Relay output	7.4.1
Oxygen	Zirconia	12.2.8	RangeLow	IO - Thermocouple input	7.5.1
OxygenExp	Zirconia	12.2.8	Rate	Setpoint	17.6.5
Parity	Comms - CC (config)	10.1.1	Rate Disable	Output function block	17.7
Parity	Comms - Modbus	10.4.2	Rate Disable	Setpoint	17.6.5
Passcode1	Instrument - InstInfo	6.3	Rate Disable	Output function block	17.7
Passcode2	Instrument - InstInfo	6.3	RateDone	Setpoint	17.6.5
Passcode3	Instrument - InstInfo	6.3	RateResolution	Programmer - Setup	18.1
PB Units	Loop set up	17.3	ReadOnly	Comms - SCADA Table	24.1
PID Set	Programmer - Setup	18.1	Reference	Analogue alarms	8.5
Poly En	Instrument - Enables	6.1	RelCh2Gain 1, 2, 3	Loop PID	17.4.10
PowerFailAct	Programmer - Setup	18.1	RelHumid	Humidity	12.1.4
Pref mstr IP 1	Comms - EtherNet	10.10.5	RemGasEn	Zirconia	12.2.8
Pref mstr IP 2	Comms - EtherNet	10.10.5	RemGasRef	Zirconia	12.2.8
Pref mstr IP 3	Comms - EtherNet	10.10.5	RemOPH	Output function block	17.7
Pref mstr IP 4	Comms - EtherNet	10.10.5	RemOPL	Output function block	17.7
Pressure	Humidity	12.1.4	Remotelnput	Loop PID	17.4.10
PrgIn1 & 2	Programmer - Setup	18.1	Reset	Counter	11.1.1
Probe Type	Zirconia	12.2.8	Reset	Totaliser	11.3.1
ProbeFault	Zirconia	12.2.8	Reset	Input monitor	13.2
ProbeInpurt	Zirconia	12.2.8	ResetEventOuts	Programmer - Run Status	18.1
ProbeOffset	Zirconia	12.2.8	ResetUVal	Programmer - Run Status	18.1
ProbeStatus	Zirconia	12.2.8	Resolution	IO - Thermocouple input	7.5.1
Prog En	Instrument - Enables	6.1	Resolution	IO - PRT input	7.6.1
Prog Hold	Programmer - Setup	18.1	Resolution	IO - Analogue output	7.7
Prog Reset	Programmer - Setup	18.1	Resolution	Totaliser	11.3.1
Prog Run	Programmer - Setup	18.1	Resolution	Humidity	12.1.4
ProgError	Programmer - Setup	18.1	Resolution	Zirconia	12.2.8
ProgPVstart	Instrument - Options	6.2	Resolution	Maths operators	14.3.2
ProgRunHold	Programmer - Setup	18.1	Resolution	Multi operators	14.4.3
ProgRunReset	Programmer - Setup	18.1	Resolution	Input linearisation	15.1.2
ProgStatus	Programmer - Run Status	18.1	Resolution	Polynomial	15.2
ProgTimeLeft	Programmer - Run Status	18.1	Resolution	Load	16.1
ProportionalBand1, 2, 3	Loop PID	17.4.10	Resolution	Programmer - Setup	18.1
Protocol	Comms - CC (config)	10.1.1	Resolution	User values	21.1
Protocol	Comms - Modbus	10.4.2	Ripple Carry	Counter	11.1.1
Protocol	Comms - Devicenet	10.7.1	RstNewAlarm	Alarm summary	8.7
Protocol	Comms - Profibus	10.9.1	RstNewCTAlarm	Alarm summary	8.7
Protocol	Comms - EtherNet	10.10.5	RTClck En	Instrument - Enables	6.1

MINI8 CONTROLLER: ENGINEERING HANDBOOK

Parameter	Folder	Section	Parameter	Folder	Section
Run	Totaliser	11.3.1	Status	Transducer scaling	20.4
Safe OP Val	Output function block	17.7	Status	User values	21.1
Sat-Sun	Real time clock	11.4	Status	Calibration	22.5
Saturday	Real time clock	11.4	Subnet Mask 1	Comms - EtherNet	10.10.5
Sbrk	Humidity	12.1.4	Subnet mask 2	Comms - EtherNet	10.10.5
SBrk Alarm	IO - Thermocouple input	7.5.1	Subnet Mask 3	Comms - EtherNet	10.10.5
SBrk Alarm	IO - PRT input	7.6.1	Subnet Mask 4	Comms - EtherNet	10.10.5
SBrk Type	IO - Thermocouple input	7.5.1	Sum Out	Multi operators	14.4.3
SBrk Type	IO - PRT input	7.6.1	Sunday	Real time clock	11.4
SBrk Value	IO - Thermocouple input	7.5.1	Switch High	Switch over	19.1
SBrk Value	IO - PRT input	7.6.1	Switch Low	Switch over	19.1
SBrkAlarmStatus1	Alarm summary	8.7	SwOver En	Instrument - Enables	6.1
SbrkAlarmStatus2	Alarm summary	8.7	Syncln	Programmer - Setup	18.1
SbrkAlarmStatus3	Alarm summary	8.7	Tare Value	Transducer scaling	20.4
SbrkAlarmStatus4	Alarm summary	8.7	Target	Counter	11.1.1
SbrkOp	Output function block	17.7	TargetSP	Loop - main	17.2
SbrkOutput	IO - Thermocouple input	7.5.1	Templnput	Zirconia	12.2.8
SbrkOutput	IO - PRT input	7.6.1	TempOffset	Zirconia	12.2.8
SbyAct	IO - Logic output	7.3.1	Tens	BCD Input	9.1
SbyAct	IO - Relay output	7.4.1	Threshold	Analogue alarms	8.5
SbyAct	IO - Fixed IO	7.8	Threshold	Input monitor	13.2
Scale Low	Transducer scaling	20.4	Thursday	Real time clock	11.4
Scheduler	Loop PID	17.4.10	Time	Timer	11.2.6
SchedulerType	Loop PID	17.4.10	Time	Real time clock	11.4
SegDuration	Programmer - Run Status	18.1	Time Above	Input monitor	13.2
Segments Left	Instrument - Diagnostics	6.4	Time2Clean	Zirconia	12.2.8
SegRate	Programmer - Run Status	18.1	TimeConst1	Load	16.1
SegTarget	Programmer - Run Status	18.1	TimeConst2	Load	16.1
SegTimeLeft	Programmer - Run Status	18.1	Timer En	Instrument - Enables	6.1
Select	Mux8 operators	14.5.1	Tolerance	Zirconia	12.2.8
SelectIn	Switch over	19.1	Totalise En	Instrument - Enables	6.1
SensorBreak Mode	Output function block	17.7	TotalOut	Totaliser	11.3.1
Serial No	Instrument - InstInfo	6.3	Track Enable	Output function block	17.7
Servo	Programmer - Setup	18.1	Track PV	Setpoint	17.6.5
ServoToPV	Setpoint	17.6.5	Track SP	Setpoint	17.6.5
ShuntOut	Transducer scaling	20.4	TrackOutVal	Output function block	17.7
SkipSeg	Programmer - Setup	18.1	Triggered	Timer	11.2.6
SootAlm	Zirconia	12.2.8	TrScale En	Instrument - Enables	6.1
Source	Comms - SCADA Table	24.1	Tuesday	Real time clock	11.4
SP HighLimit	Setpoint	17.6.5	Type	Analogue alarms	8.5
SP LowLimit	Setpoint	17.6.5	Type	Digital alarms	8.6
SP Select	Setpoint	17.6.5	Type	Timer	11.2.6
SP Track	Setpoint	17.6.5	Type	Load	16.1
SP Trim	Setpoint	17.6.5	Type	Loop set up	17.3
SP1	Setpoint	17.6.5	UnitID Enable	Comms - EtherNet	10.10.5
SP2	Setpoint	17.6.5	Units	Instrument - Options	6.2
SPIn	Programmer - Setup	18.1	Units	IO - Thermocouple input	7.5.1
SPIntBal	Setpoint	17.6.5	Units	IO - PRT input	7.6.1
SPTrim HighLimit	Setpoint	17.6.5	Units	BCD Input	9.1
SPTrim LowLimit	Setpoint	17.6.5	Units	Totaliser	11.3.1
Stage	Loop tune	17.5.5	Units	Maths operators	14.3.2
Stage Time	Loop tune	17.5.5	Units	Multi operators	14.4.3
Standby	Access	5.0	Units	Input linearisation	15.1.2
Start Cal	Transducer scaling	20.4	Units	Polynomial	15.2
Start HighCal	Transducer scaling	20.4	Units	Load	16.1
Start Tare	Transducer scaling	20.4	Units	Programmer - Setup	18.1
State	Loop tune	17.5.5	Units	User values	21.1
Status	IO - Thermocouple input	7.5.1	UserStringCharSpace	Instrument - Diagnostics	6.4
Status	IO - PRT input	7.6.1	UserStringCount	Instrument - Diagnostics	6.4
Status	IO - Analogue output	7.7	UsrVal En1	Instrument - Enables	6.1
Status	Comms - Devicenet	10.7.1	UsrVal En2	Instrument - Enables	6.1
Status	Logic operators	14.1.3	UsrVal En3	Instrument - Enables	6.1
Status	Maths operators	14.3.2	UsrVal En4	Instrument - Enables	6.1
Status	Mux8 operators	14.5.1	UValName	Programmer - Setup	18.1
Status	Polynomial	15.2	Val	User values	21.1
Status	Switch over	19.1	Version	Instrument - InstInfo	6.3

Parameter	Folder	Section
Wait	Comms - CC (config)	10.1.1
Wait	Comms - Modbus	10.4.2
WDAct	Comms - Modbus	10.4.2
WDAct	Comms - Devicenet	10.7.1
WDAct	Comms - Profibus	10.9.1
WDAct	Comms - EtherNet	10.10.5
WDFlag	Comms - Modbus	10.4.2
WDFlag	Comms - Devicenet	10.7.1
WDFlag	Comms - Profibus	10.9.1
WDFlag	Comms - EtherNet	10.10.5
WDTime	Comms - Modbus	10.4.2
WDTime	Comms - Devicenet	10.7.1
WDTime	Comms - Profibus	10.9.1
WDTime	Comms - EtherNet	10.10.5
Wednesday	Real time clock	11.4
WetOffset	Humidity	12.1.4
WetTemp	Humidity	12.1.4
WorkingSP	Loop - main	17.2
Zirconia En	Instrument - Enables	6.1

Eurotherm: International sales and support www.eurotherm.com

Contact Information

Eurotherm Head Office

Faraday Close,
Durrington,
Worthing, West Sussex,
BN13 3PL

Sales Enquiries

T +44 (01903) 695888
F 0845 130 9936

General Enquiries

T +44 (01903) 268500
F 0845 265982

Worldwide Offices

www.eurotherm.com/global



Scan for local contacts



©Copyright Invensys Eurotherm Limited 2013

Invensys, Eurotherm, the Eurotherm logo, Chessell, EurothermSuite, Mini8, Eycon, Eyris, EPower, EPack nanodac, piccolo, Foxboro, and Wonderware are trademarks of Invensys plc, its subsidiaries and affiliates. All other brands may be trademarks of their respective owners.

All rights are strictly reserved. No part of this document may be reproduced, modified or transmitted in any form by any means, neither may it be stored in a retrieval system other than for the purpose to act as an aid in operating the equipment to which the document relates, without the prior written permission of Invensys Eurotherm Limited.

Eurotherm Limited pursues a policy of continuous development and product improvement. The specifications in this document may therefore be changed without notice. The information in this document is given in good faith, but is intended for guidance only.

Eurotherm Limited will accept no responsibility for any losses arising from errors in this document.

i n v e n s y s
Operations Management