

Production

Maintenance

Process Optimization

Quality Assurance

NON-CONTACT TEMPERATURE MEASUREMENT METAL INDUSTRY

innovative infrared technology

↑ 2409.8 °F

Environmental influences

From the image below it is apparent that the transmission of the air is very strongly dependent on wavelength. Areas with high attenuation alternate with areas of high permeability, the so-called atmospheric windows. In the long-wave atmospheric window (8–14 μm), the permeability is consistently high, while in the short-wave range measurable attenuation occurs via the atmosphere which can lead to distorted measurement results. Typical measurement windows there are 1.1–1.7 μm , 2–2.5 μm and 3–5 μm .

Other influencing variables are possible thermal radiation sources in the vicinity of the measurement object. To avoid distorted measurements due to increased ambient temperatures (e.g. when measuring the temperature of bearing rings in a hardening furnace where the walls are hotter than the measurement object) the infrared measuring device features adjustable compensation for ambient temperature influences. The most accurate measuring results can be achieved using a second temperature measurement head for automatic ambient temperature compensation and correctly adjusted emissivity.

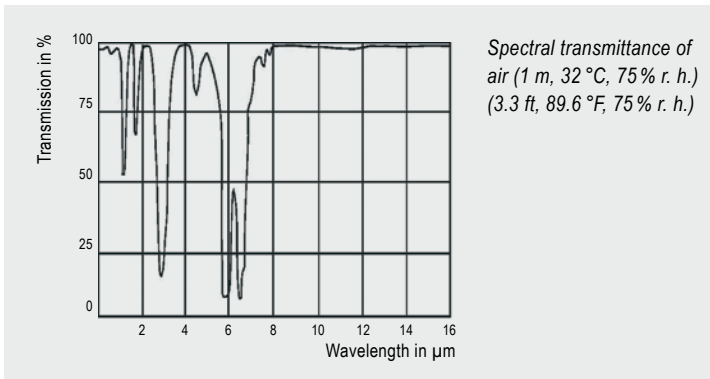

Dust, smoke and suspended matter in the atmosphere can soil the lens which can result in incorrect measurement results. The use of an air purge collar (a screw-on nozzle with compressed air connection) prevents suspended matter from getting deposited in front of the lens. Air and water-cooling accessories enable the use of infrared thermometers even in harsh environmental conditions.

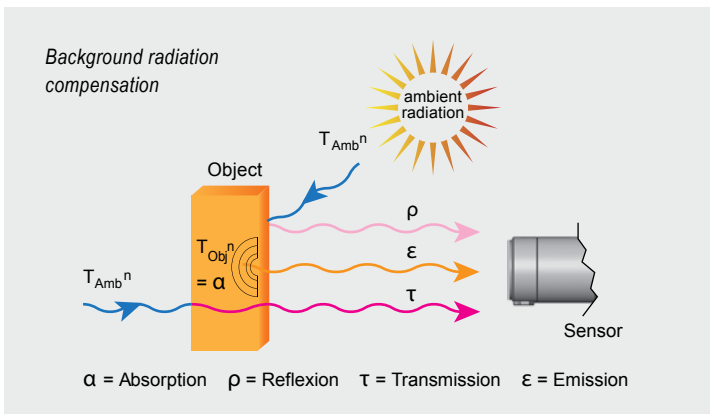

Emissivity and temperature measurement of metals

Emissivity is a major factor in the accurate measurement of temperatures. It must be adjusted according to the application.

Emissivity theoretically depends on the material, its surface quality, the temperature, the wavelength, the measuring angle and, in some cases, even the applied measuring configuration. Many non-metallic surfaces to be measured have a constant emissivity with regard to wavelength but emit less radiation than black bodies. They are called gray bodies.

Objects whose emissivity depends, amongst other things, on temperature and wavelength, e.g. metallic surfaces, are called selective radiators.

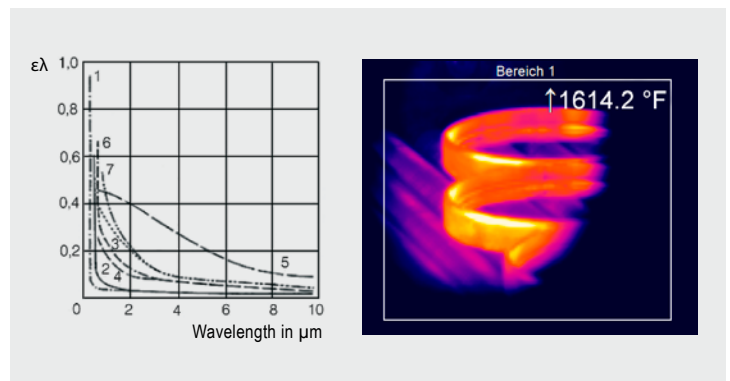

Spectral emissivity of metals: 1 Silver, 2 Gold, 3 Platinum, 4 Rhodium, 5 Chrome, 6 Tantalum, 7 Molybdenum *Measuring of bearing rings during the hardening process*

There are several important reasons why the measurement of metals should, if possible, always be done in the short-wave range. Firstly, at high temperatures and short measuring wavelengths (2.3 μm ; 1.6 μm ; 1.0 μm), metal surfaces do not just have the highest radiation intensity, they also have the highest emissivity.

Secondly, in this range they equal the emissivity of metal oxides so that temperature deviations caused by changing emissivities are minimized.

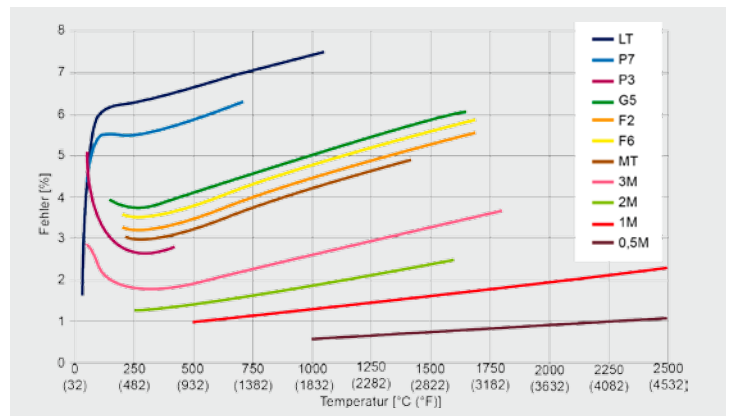

Measuring error in the case of emissivity wrongly adjusted by 10% as a function of the wavelength and object temperature (LT: 8–14 μm ; P7: 7.9 μm ; P3: 3.43 μm ; G5: 5 μm ; MT: 3.9 μm ; F2: 4.24 μm ; F6: 4.64 μm ; 3M: 2.3 μm ; 2M: 1.6 μm ; 1M: 1.0 μm ; 05M: 525 nm).

Avoiding breaches

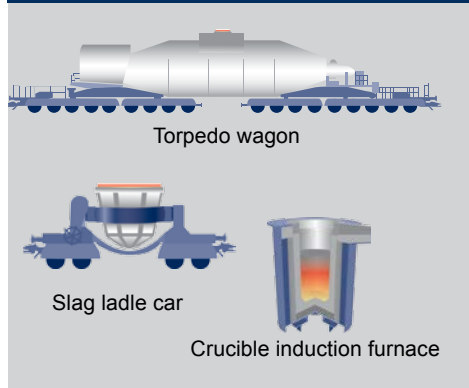

Task:

Steel needs to be transported in various vessels including torpedo wagons, slag ladle cars and smelting ladles. Even if the wagons and ladles are equipped with fireproof materials, breaches may result due to the 1500 °C (2732 °F) hot steel. This presents a danger to both the stock and personnel which could result in millions of euro in damages. To prevent any such breaches the vessels are monitored with thermal imaging cameras and protected via recognition of temperature differences.

Process temperature:

300 °C to 600 °C (572 °F to 1112 °F)

Recommended measurement devices:

- optris PI 400
- optris PI 640

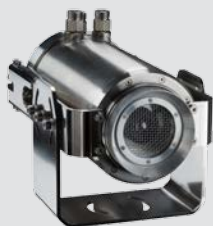

Monitoring of the refractory lining of a slag ladle car while pulling out of the factory

Preventing aborted pours

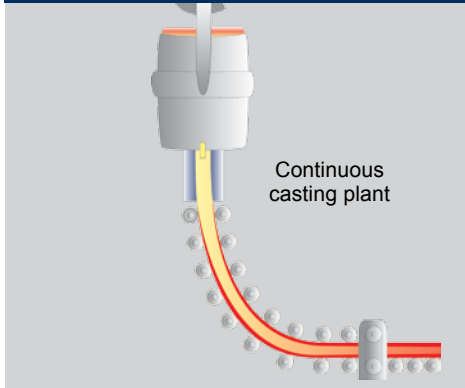

Task:

Thanks to improved efficiency the demands on continuous casting lines are also increasing. This necessitates extensive process monitoring measures, especially where temperature measurement is concerned: the technology has become cheaper with increased levels of precision. For the operators the investment is worthwhile, as costly aborted pours can be avoided at the point of origin.

Process temperature:

800 °C to 1000 °C (1472 °F to 1832 °F)

Recommended measurement devices:

- optris PI 1M
- optris CTlaser 1M
- optris CTratio 1M



Run-off area of a continuous casting plant

Process optimization on the rolling train

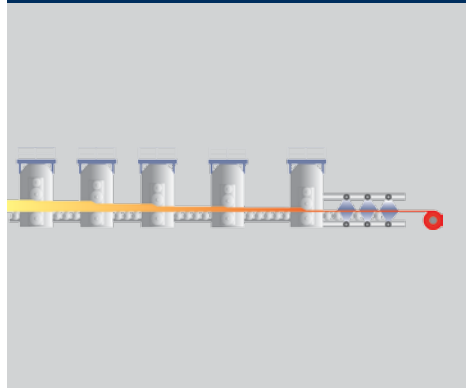

Task:

In the manufacturing of semi-finished products the slabs are cooled from around 1250 °C (2282 °F) in racks. For quality assurance and process optimization the forming temperature is measured between the individual rollers.

Process temperature:

700 °C to 1100 °C (1292 °F to 2012 °F)

Recommended measurement devices:

- optris PI 1M
- optris CTlaser 1M / 2M
- optris CTvideo
- optris CSvideo



Hot working of sheet metals and manufacturing of wire

Applications of temperature measurement technology

PRODUCTION PROCESSES IN THE METAL INDUSTRY

Workpiece control in drop forging



Task:

In die forging the semi-finished products need to reach a particular forging temperature before forming. To get the best possible production results the surface temperature of the material is monitored accordingly. The same goes for the forging after forming or before storing.

Process temperature:

700 °C to 1250 °C
(1292 °F to 2282 °F)

Recommended measurement devices:

- optris PI 1M
- optris CTlaser 1M
- optris P20 1M

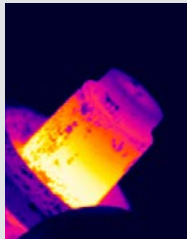

Deep drawing

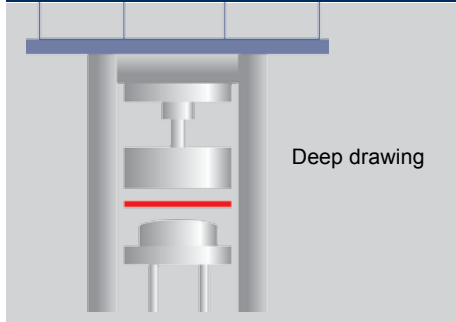

Task:

For stable process control when deep drawing, the die and sheet metal temperatures need to be measured permanently.

Process temperature:

200 °C to 350 °C (392 °F to 662 °F)

Recommended measurement device:

- optris CTlaser 3M



Bath tubs as deep-draw products

Temperature monitoring in the casting process

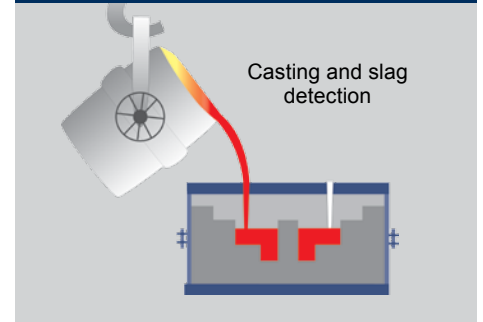

Task:

In the casting manufacturing process, liquid materials are poured into a mold, and this becomes a solid body after it sets. At the moment of casting the temperature of the material is measured in order to influence the cooling phase which is decisive for quality.

Process temperature:

1250 °C to 1600 °C
(2282 °F to 2912 °F)

Recommended measurement devices:

- optris PI 05M
- optris CTlaser 05M
- optris P20 05M

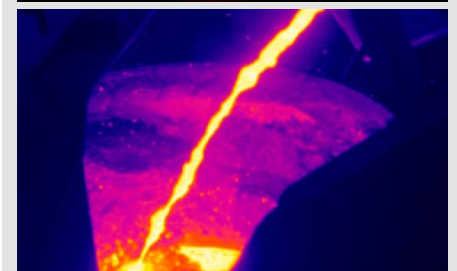

Measurement of casting stream during casting into a mold

Ensuring the monitoring of materials

Task:

The manufacturing of metal products is almost exclusively automated because of the high process temperatures. Here, the precise assessment of the workpieces out of the mold is very important for the monitoring of the materials or reject control.

Process temperature:

150 °C to 900 °C
(302 °F to 1652 °F)

Recommended measurement devices:

- optris PI 1M
- optris CT 3M and CTlaser 3M



Quick assessment of a steel slab for monitoring of materials

Slag detection

Task:
In the manufacturing of metals, slag – a non-metallic smelting residue – is a by-product of various processes. To increase the quality of the end product the amount of slag needs to be kept as low as possible.

The optris PI Connect software provides the option of measuring the percentage of slag in the material with the infrared cameras so that residues can be skimmed off where necessary. Here, a camera with 7.9 µm spectral sensitivity is used.

Process temperature:
1250 °C to 1500 °C
(2282°F to 2732°F)

Recommended measurement device:

- optris PI 450/640 G7

Efficient induction hardening

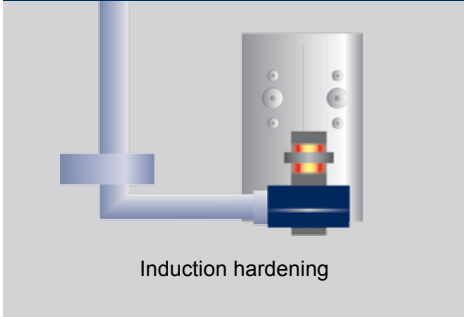

Task:
In (partial) induction hardening an area is brought to a required hardness temperature and subsequently quenched. For this process it is extremely important to adhere to an optimum time/temperature profile in order to achieve the desired structural composition of the metal.

Process temperature:
700 °C to 1100 °C (1292 °F to 2012 °F)

Recommended measurement devices:

- optris PI 1M
- optris CTlaser 1M / 2M
- optris P20 1M / 2M



Inductively heated pipe

Quality assurance in induction welding

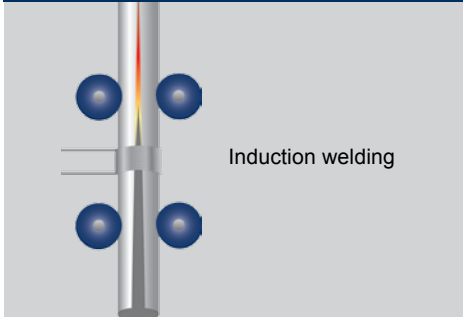

Task:
In the manufacturing of induction welded joints, in pipes for example, the quality needs to be assured. For this purpose the temperature of the rims is recorded after the inductor and before the squeeze rollers, with the process controlled in this manner.

Process temperature:
950 °C to 1450 °C (1742 °F to 2642 °F)

Recommended measurement devices:

- optris PI 05M
- optris CTratio 1M



Temperature monitoring of pipe rims shortly before welding

Optimization of the galvanization process

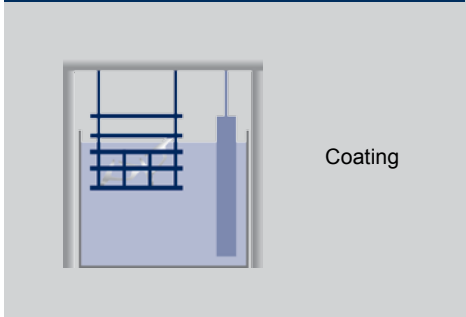

Task:
Products are often coated with metals, for example with copper and nickel, to increase their strength. The objects to be coated are brought to the desired temperature in front of the galvanizing bath to optimize the electrochemical reaction.

Process temperature:
150 °C (302 °F)

Recommended measurement devices:

- optris PI 640
- optris CTlaser 3M



Chrome-plated gear part

Metal industry

INFRARED CAMERAS AND INFRARED THERMOMETERS

The infrared cameras in the optris PI series are fixed thermography systems that offer outstanding value for money. The short-wave cameras (500 nm and 1 μm) are used in the metal industry for extremely reflective surfaces. The thermal imaging cameras are connected to a computer via USB 2.0 or integrated into a PLC and are ready to use immediately after connecting.

Compact speciality cameras for the metal industry

Both the **optris PI 1M** and **optris PI 05M** are cameras made specifically for the metal industry. Thanks to their short measuring wavelengths of 500 nm (19.7 μin) and 1 μm (39,37 μin) they are particularly suited to temperature measurements of metals, because at higher temperatures and short measuring wavelengths metal surfaces have the highest radiation intensity and highest emissivity (see p. 2). With their high maximum image frequency of 1 kHz these cameras can be used for very fast processes.



The **PI 05M** allows for exact measurements at changing emissivities with simultaneously low interference due to atmospheric influences.

The outstanding blocking of radiation above 540 nm allows the camera to be also used in all laser working processes in which either modern solid-state lasers, which typically work in near-infrared, or gas lasers (e. g. CO₂ laser at 10.6 μm) (417,32 μin) are employed.

In addition the optris **PI 450/640 G7** is used in the field of slag detection. In this spectral range (7.9 μm) (311.02 μin) the differences in emissivity between the molten metal and the surface of the slag are relatively big. It is this feature that is used for the detection of slag. Special analysis tools in the PI Connect software allow the percentage of slag to be displayed.

optris® PI Connect license-free software

The PI Connect software provides outstanding customization options for its respective applications. With SDKs for Windows and Linux the cameras can be easily integrated into applications and control systems. In confined spaces the 1 kHz line scan camera function can be employed. Merging – the combining of several cameras in a single software window – is also possible. Both the optris PI 05M and the optris PI 1M infrared cameras offer an optical resolution of 764 x 480 pixels.

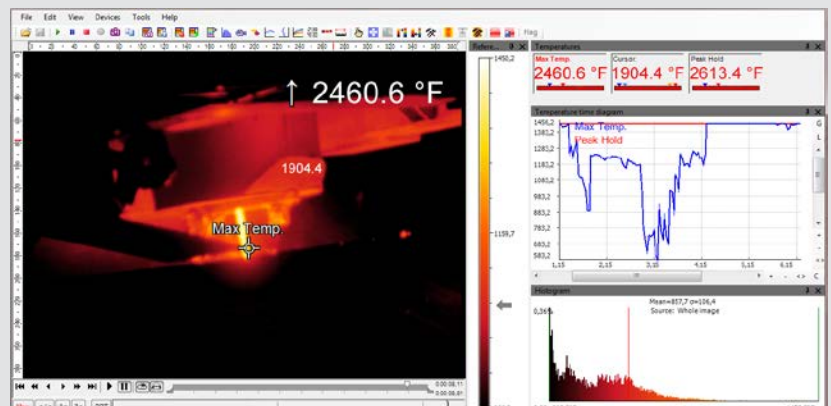

The optris CSvideo 2M and CTvideo 1M/2M/3M **video pyrometers** feature a built-in trigger function which allow automatic time-dependent or temperature-dependent snapshots to be generated. This provides automated visual documentation for quality assurance.



optris® CSvideo 2M and CTvideo 1M/2M/3M

The similarly integrated **variable lens** offers stepless focusing from a measuring distance of 90 mm (3.5 in) and above. This allows tiny objects from 0.5 mm (0.02 in) to be precisely measured. The parallel use of the **video module** and the patented cross-hair laser sight enable the simple and precise selection of the measuring field, even if the measuring object is located in a hard-to-reach area.

The optris P20 05M, optris P20 1M and optris P20 2M industrial handheld thermometers measure surface temperatures between 385 °C and 2000 °C (725 °F and 3632 °F) meaning they are ideally suited to the high temperature measurement of molten metal.



optris® P20 05M/1M/2M

Up to 2000 measurement readings can be stored in the internal memory of the portable measurement device. As well as this, the laser thermometer features a USB connection for the evaluation and analysis of the measured data on computer. The accompanying optris Connect evaluation and report software also features an oscilloscope function for 20 measurements per second.

The optris CSLaser 2M infrared thermometer was specifically developed for **exact temperature measurements of metal surfaces**. Its short measuring wavelength enables the precise measurement of metal temperatures and metal oxides.



optris® CSLaser 2M

The robust, one-piece IR thermometer can be easily integrated into a facility. The standardized two-wire interface guarantees the reliable transfer of the data as well as simple integration into a PLC. The IR thermometer features an innovative double laser sight for the exact selection of the measurement spot. With a variety of lenses it can be customized to a variety of applications.

The optris CTlaser 05M/1M/2M/3M infrared thermometers were specifically developed for the temperature measurement of metal surfaces and molten metals. They feature short-wave spectral ranges of 525 nm (05M), 1 µm (1M), 1.6 µm (2M) and 2.3 µm (3M), which also minimize measurement errors in the case of changes in emissivity. The temperature ranges of the thermometers are between 50 °C and 2200 °C (122 °F and 3992 °F).

optris® CTlaser 05M/1M/2M/3M

With their extremely short response time of 1 ms, these highly efficient thermometers enable the monitoring of quick processes, measuring precisely and reliably even for the smallest measuring fields of up to 0.7 mm (0.03 in). Thanks to its innovative double laser sight, the robust, high quality stainless steel measuring head of the CTlaser also enables the exact selection of the measuring field from any distance. In addition, selectable analog outputs and various digital interfaces provide a high level of variability in the evaluation of the measured data. For use in high ambient temperatures the measuring head can be optionally fitted with a water cooling system or with a protective housing (CoolingJacket Advanced).



innovative infrared technology

Optris Infrared Sensing, LLC
200 International Drive
Suite 170
Portsmouth, NH 03801 USA
Phone: (603) 766-6062
E-mail: sales@optris-ir.com
www.optris.com

