



World-Class Control
and Versatility

Eurotherm®

Control, Optimize, Simplify

Mini8® Controller



eurotherm.com/mini8

Life Is On

Schneider
Electric

Mini8 Controller

Our range of controllers provide world class control and versatility with clear, user friendly, configuration tools. Add to this a strong sales team of qualified engineers who understand your process, and an absolute commitment to innovation by continuously investing in research and development. This combination brings you peace of mind that your process control is in the hands of industry experts.



Product at a glance

Control Features

- 4, 8 or 16 PID Loops
- Dual Channel Output
- Autotune

Data Acquisition Capability

- 32 Thermocouple, mV
- 16 RTD

IO Modules

- 4 Channel Thermocouple/mV
- 8 Channel Thermocouple/mV
- 4 Channel RTD
- 8 Channel Logic Output
- 8 Channel Logic Input
- 3 Channel Current Transformer Input
- 8 Channel Relay Output
- 4 Channel 4-20mA Output
- 8 Channel 4-20mA Output
- 8 Channel enhanced Thermocouple/mV*

*Requires firmware V3.01 or higher

Alarms

- High, Low Deviation
- Heater Status
- Sensor Break

Toolkit Functions

- Maths
- Combinational Logic
- Timers
- Totalizers
- Counters
- Real Time Clock
- Multiple Input (Avg, Max, Min)

8 Setpoint Programmer Blocks

Each block supports:

- 1 process variable
- Up to 8 events
- Up to 16 segments

Communications Protocols

- Modbus RTU
- DeviceNet®
- Profibus DP
- Modbus TCP
- EtherNet/IP
- EtherCAT

Maximize Your Process

Designed to integrate seamlessly with programmable logic controllers (PLC), and other supervisory control and monitoring systems, the Eurotherm Mini8 Controller offers a compact high performance solution at an affordable cost. The Mini8 controller offers modularity both in terms of hardware and software functions. Its four plug-in slots can accommodate a variety of IO modules, and its feature set is ranged to suit simple multi-loop and data acquisition applications up to complex strategies including setpoint programming, mathematical and logical operations.

The Mini8 Controller can multi-drop on either serial, fieldbus or Ethernet communications and offers a real cost effective alternative to performing analog measurement or control loops in a PLC. Implementing these functions in the Mini8 Controller helps reduce the cost of a PLC system and also relieved of the extra processing burden of analog control, often improving digital performance or enabling a lower specification processor to be used.

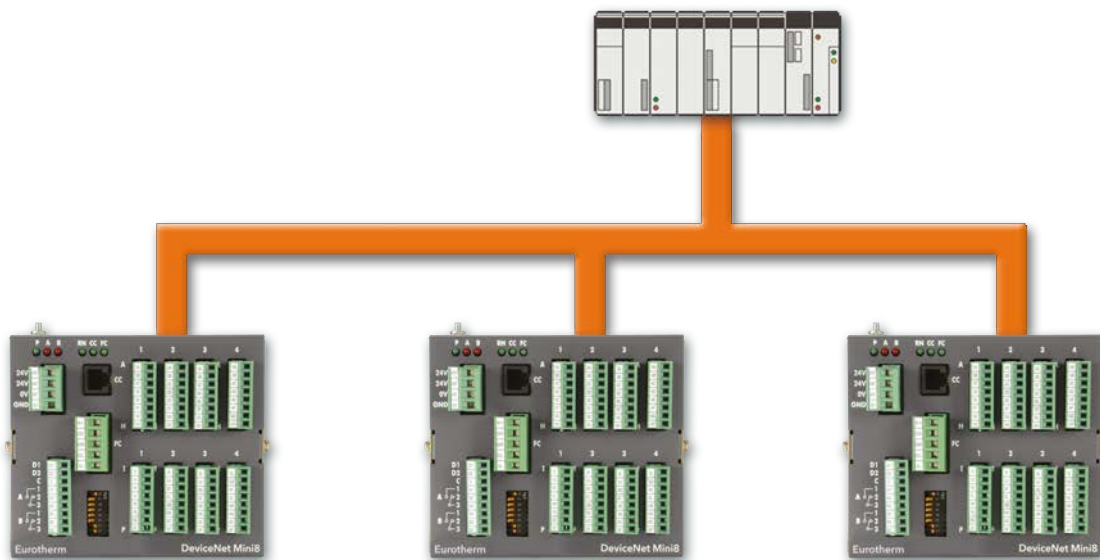

Enhance your PLC solution with Eurotherm PID Features

- Can reduce PLC hardware
- Easy and quick set-up
- Can help improve control performance
- Can help minimize signal conditioning hardware

The Mini8 Controller is an ideal partner for a PLC in multi-loop PID applications, such as plastics extrusion and multi-zone furnaces. By devolving loop control to the Mini8 Controller the PLC can concentrate on providing fast and effective logic control without the burden of running complex control algorithms. The Mini8 Controller is a very cost effective alternative to implementing control loops in a PLC. Providing not only better control performance and easy configuration, the Mini8 Controller offers the same deterministic response and autotune features as Eurotherm panel mount controllers. The Eurotherm open approach to communication, supporting serial, Fieldbus and Ethernet protocols, makes it easy to interface to intelligent masters such as PLCs.

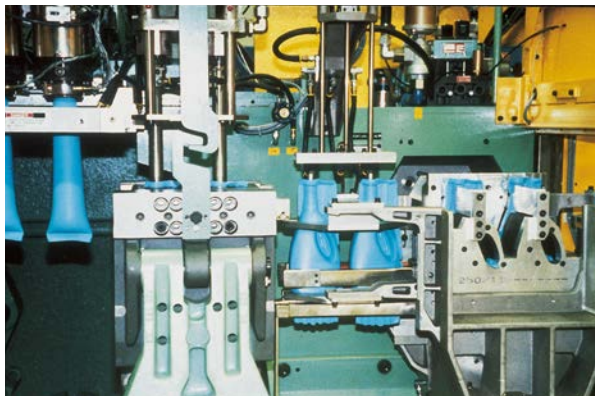

Maximize PID Control with the Mini8 Controller

- 16 PID control loops
- Flexible and standard configurations
- 110 ms PV sampling
- Setpoint programmer
- Math and logic functions
- Process alarms
- Heater failure detection
- Help defend OEM knowledge and IP with “OEM security”.

Control and Measurement

Combining high quality multi-channel analog measurement with Eurotherm’s proven PID algorithm, the Mini8 Controller achieves performance comparable with the Eurotherm 3200 Temperature Controllers. The same analog input circuitry and control features found in the Eurotherm range of nanodac™ panel mount controllers are also available in the Mini8 Controller.

Setpoint Programmer

The Mini8 Controller can run up to 8 programmer function blocks, to follow a user defined series of ramp and dwell segments. Each Programmer is capable of running a program of up to 16 segments with 8 event outputs. The event outputs can be used internally within the configuration soft wiring or to external digital or relay outputs.

Heater Failure Detection

Utilizing a unique cycling algorithm and current transformer input module, the Mini8 Controller can automatically scan electrical heaters connected to its logic or relay control outputs and indicate heater partial load failure, over current or SSR short and open circuit. Heater current readings are also available within the controller to calculate power delivered to the load and make this information available to a supervisory system. Heater failure detection is compatible with both single or three phase load installations.

Creating Custom Solutions

A wide range of toolkit functions, including Math and Logic blocks, can be used to create custom solutions and small machine controllers. Timing functions include a range of timers, counters and totalizers as well as a non-volatile real time clock. Using the Eurotherm iTools graphical wiring editor these strategies can easily be created and documented.

“OEM Security” Feature

Users can help protect their intellectual property by using the “OEM security” feature. This helps prevent unauthorized copying of configurations without first entering a user-defined password. Therefore the full commercial benefit of a custom solution could be realized.

Communications

The Mini8 Controller utilizes a fixed Modbus address table providing easy integration into PLC, SCADA and other 3rd party systems. This fixed table makes communication to intelligent masters very easy to accomplish. Parameter addresses are fixed in one location and do not move depending upon how the unit is configured. Modbus RTU, DeviceNet®, Profibus, EtherNet/IP EtherCAT and Modbus TCP/IP protocols are supported. The Mini8 Controller can be supplied with pre-loaded configurations to suit standard applications. It is also a very flexible controller capable of implementing complex control strategies. Eurotherm iTools software provides a graphical function block view of strategies making creation, editing and debugging easy to accomplish.

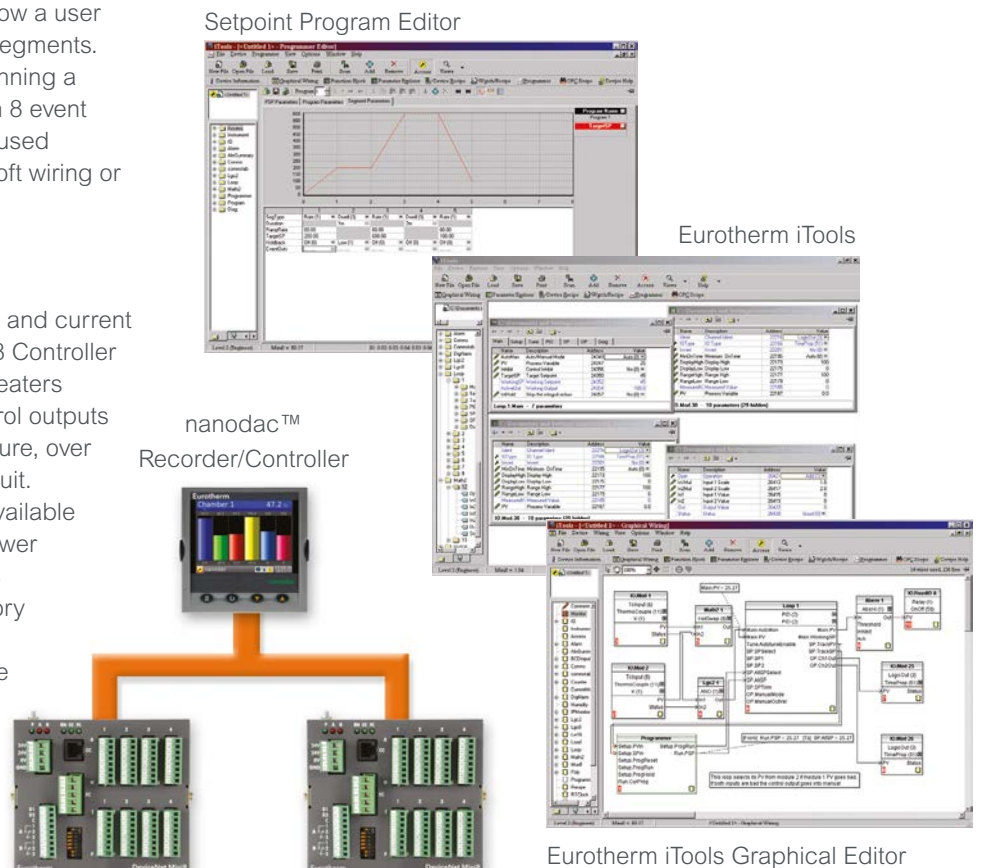

Data Acquisition with the Mini8 Controller

The Mini8 Controller high density analog inputs combined with the Eurotherm 6000 Series paperless graphics recorders provide local and network access to your process.

The 6000 Series offers remote viewing capability and acts as an HMI for the Mini8 Controller utilizing Master Communications. The user can control and view information from the Mini8 Controller from either the 6000 TFT touchscreen display or from any PC connected to the network:

- 32 Analog channels per Mini8 Controller
- Multiple batch functionality
- Master communications
- Alarm notification via Email
- Long term storage of data
- Easy to use networking
- Auditor features
- Up to 48 universal inputs direct into the 6000

The Mini8 Controller Connected to a 6000 Series Recorder in a Control System

The 6000 Series supports Modbus Master communications over Ethernet and Serial connections. Powerful features from within the 6000 Series — such as user defined screens, remote access and Auditor features — can now be applied to other plant equipment. Whether you need to securely record data from other instruments or provide a centralized HMI for 6000 Series for an operator to view and modify control loop parameters within the Mini8 Controller — the 6000 Series offers a simple, powerful solution.

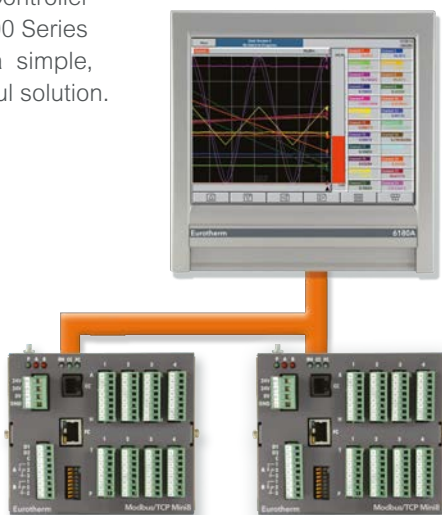

Eurotherm 6000 Series

The 6000 Series is designed to provide powerful, yet easy to use, network and communication options. Whether a local connection is required or access from the other side of the world, the 6000 Series provides long term storage and access to process data when and where you need it.

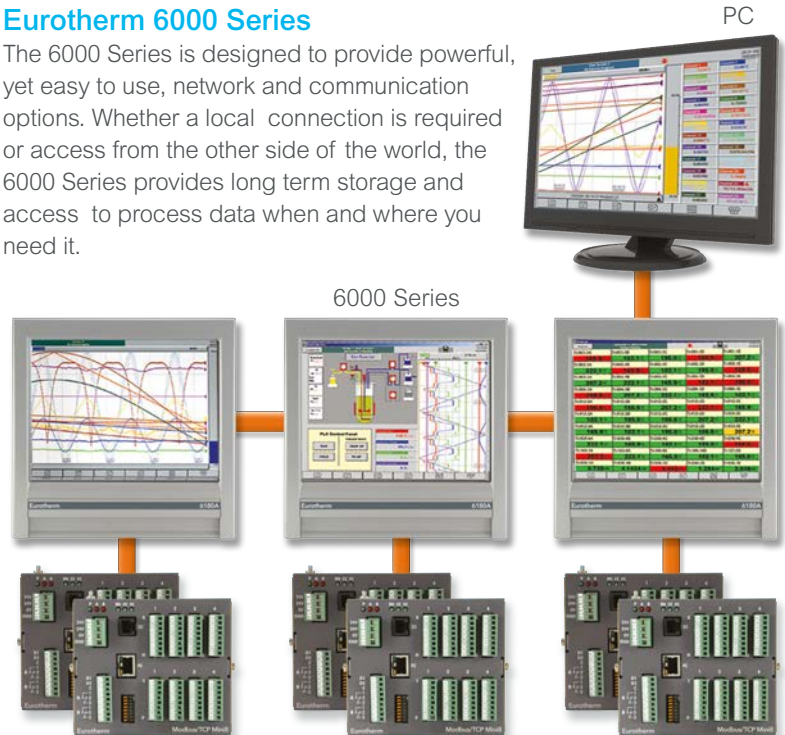

The Mini8 Controller Connection to SCADA

The Mini8 Controller can be installed as a control or data acquisition component of larger installations. Eurotherm is able to provide solutions from “simple” SCADA using Eurotherm iTools to more demanding applications using Wonderware® System Platform. The open communications nature of the Mini8 Controller makes communication with third party equipment easy to achieve.

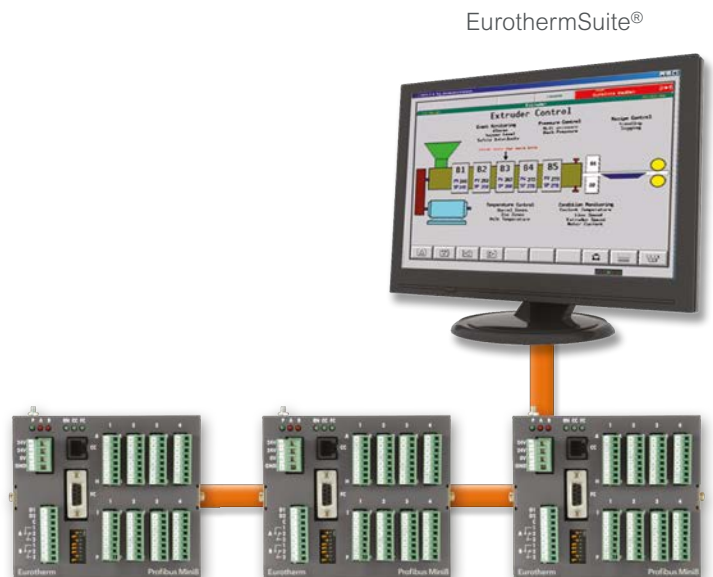

Real-World Application

Heater Failure Detection

A typical furnace control process consists of 16 heater loads wired in parallel to produce both the required heating rate and maximum temperature. A common recurring problem was that if any one or more heaters failed it was not noticed until the process was under way. Typically this resulted in the furnace being out-of-service until the faulty heater load was replaced.

The Mini8 Controller fitted with a CT3 card has the capability of detecting failures of any one of 16 heaters, which can then be repaired before a run is started. Failure modes that can be detected are: SSR Fault, Partial Load Fault (PLF) and Over Current Fault (OCF).

SSR Fault

If current is detected flowing through a heater when the controller is requesting it to be off, then this typically indicates that an SSR has a short circuit. If current is not detected when the controller is requesting the heater to be on, then this typically indicates that the SSR has an open circuit.

Partial Load Fault (PLF)

If less current is detected flowing through a heater than the PLF threshold, which has been set for that channel, then this typically indicates that the heater may have a fault. In applications that use multiple heater elements in parallel, it could indicate that one or more of the elements may have an open circuit.

Over Current Fault (OCF)

If more current is detected flowing through a heater than the OCF threshold, then this indicates that the heater has an issue. In applications that use multiple heater elements in parallel then this indicates that one or more of the elements has lower than expected resistance value.

Example

Multiple SSR Triggering

With this configuration, failure of a set of heater loads can be detected. For example, if the current detected flowing through Heater Set 1 is less than the PLF threshold of Load 1 then this will be indicated as 'Load 1 Fault'. Further investigation will then be required to determine which heater within Set 1 has failed.

Possible benefits

- Reduced down time
- Less scrap
- Increased production

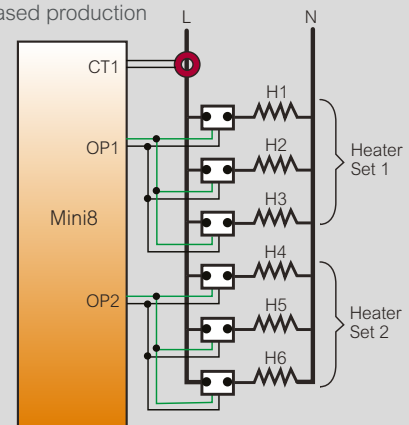

Success Stories and Commercial Benefits

Case Study — PECVD Solar Cell Fabrication

During the PECVD (Plasma-Enhanced Chemical Vapor Deposition) phase of Photovoltaic Solar Cell fabrication, it is essential for high quality and maximum throughput that all control zones are kept within strict process limits, creating a uniform temperature profile within the furnace.

Customer Challenge

Typically, a PECVD furnace has 5 control zones, all of which have significant process lags making temperature control challenging. Additionally, it is not possible during production to measure the actual surface temperature of the wafer and the process is often affected by disturbances such as the door opening and gas being admitted to the chamber. The challenge is therefore to maximize the production time by helping to ensure uniformity between all zones and recovering as quickly as possible from process disturbances.

Solution

- 5 Zone Cascade Control compensating for process lags
- Custom Linearization blocks for thermocouple profile characterization
- Custom math block algorithm to help optimize temperature uniformity
- Communications to PC/PLC host system

Customer Benefits

- Improved quality by accurate temperature control of wafer and uniform temperature profile across all zones
- Fast response to process disturbances to help maximize production throughput
- Integrates easily with PECVD control system

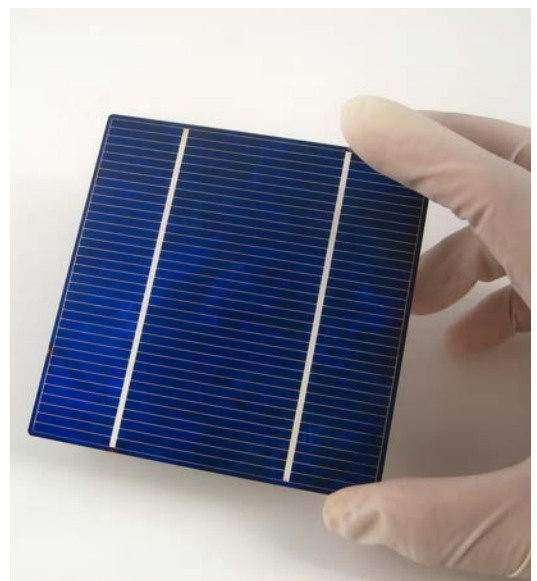

Case Study — Consistency is essential in glass-to-metal seals manufacture

A compression hermetic seal is produced when the metal housing material thermal expansion rate is much higher than that of the glass. Upon solidification of the seal during the manufacturing process, the housing will contract around the glass, applying a desirable compression stress on the glass bead. The consistency of glass produced depends on the accuracy of the temperature control. The strength of the glass-to-metal seal is reinforced mechanically as well as chemically, creating a stronger, more durable part.

Customer Challenge

This customer sought Eurotherm's expertise as they were having problems with their glass to metal compression seals manufacture.

They needed precise temperature control to provide improvements in product quality, consistency and repeatability.

Solution

- Mini8 Controller
- 6000 data acquisition to meet industry regulations

Customer Benefits

Very accurate temperature control of the company's multi-zone furnaces. The Mini8 Controller helps provide high stability operation, reduced wastage and maximizes production.



Specifications

Control Features	4, 8 or 16 Loops with autotune, Dual Channel OP with various cooling modes, PID, On/Off, Auto/Man, Feedforward, 3 PID sets, Remote SP, Forced manual, Sensor break OP, SP ramp, OP rate limit, Heater failure detection
Communications	Network: Modbus RTU (EIA485), Modbus TCP, Profibus DP, DeviceNet®, EtherNet/IP, EtherCAT Config: Modbus RTU (EIA232), can be used as second network port
Standard IO	2 x 24 V dc Logic inputs with 42 V ac/dc system isolation 2 x 1 Amp Change over relays (42 V ac/dc max)
ET8/TC4 /TC8 Module	TC4/TC8: 4/8 Channels, Range: -77 mV to 77 mV, Accuracy $\pm 1^{\circ}\text{C} \pm 0.1\%$ of reading, TC types: C, J, K, L, R, B, N, T, S, LINEAR, Custom, CJC >30:1, 42 V ac/dc Channel isolation, Input impedance >100 ohms ET8*: 8 Channels, Range: -77 mV to 77 mV, Accuracy $\pm 0.25^{\circ}\text{C} \pm 0.05\%$ of reading, TC types: C, J, K, L, R, B, N, T, S, LINEAR, Custom, CJC >100:1, 42 V ac/dc Channel isolation, Input impedance >100 ohms *requires firmware V3.01 or higher
RT4 Module	2, 3, or 4 wire input, Pt100 RTD or linear
DO8 Module	8 Channels, Supply: 15 V dc to 30 V dc, On/Off, Time Proportioning, Common 42 V ac/dc system isolation
DI8 Module	8 Channel logic input with 42 V ac/dc system isolation
CT3 Module	3 Channels, Range 0-50 mA, Accuracy: $\pm 2\%$ of span, No isolation
RL8 Module	8 Channel form A relay (NO) max 2 A @ 264 V ac
AO4/AO8 Module	4 or 8 Channels, Range 0-20 mA, 360R load, 42 V ac/dc channel isolation
SP Programmer	8 Programmers, 16 Segments and 8 Events each, External Run, Hold, Reset, Skip Segment, Advance Segment
Math & Logic	24 x 2 Input Math, 24 x 2 Input Logic, 4 x 8 Input logic, 4 x 8 input multiplexer, 32 User Values, 4 x 8 Multiple Input
Recipes	8 Recipes, 24 tags in total
Timer Functions	8 Timers, 2 Counters, 2 Totalizers, Non-volatile real time clock
Power Supply	17.8 V dc to 28.8 V dc, Power consumption 15 W max, 10 W typical
Approvals	EMC: EN 61326-1:2013 Class A EN 61326-1:2013 Industrial Locations EN 50581:2012 RoHS Safety: EN 61010-1:2010, UL, cUL, KC, EAC Environmental: RoHS, Green Premium, REACH

Life Is On



Discover More About Eurotherm Data Management Products

eurotherm.com/mini8

Eurotherm Limited
Faraday Close, Durrington
Worthing, West Sussex, BN13 3PL
Phone: + 44 (0)1903 268500
www.eurotherm.com



Published September 2019

Document Number HA028430 Issue 8

©2019 Schneider Electric. All Rights Reserved. Life Is On, Schneider Electric, EcoStruxure, Eurotherm, EurothermSuite, EFit, EPack, EPower, Eycon, Eyris, Chessell, Mini8, nanodac, optivis, piccolo and versadac are trademarks and property of Schneider Electric SE, its subsidiaries and affiliated companies. All other trademarks are the property of their respective owners.